IMPRESSUM / IMPRINT

Herausgeber / <i>Publisher</i>	PROJAHN Präzisionswerkzeuge GmbH · 63128 Dietzenbach · www.projahn.de
Verantwortlich / <i>Responsible</i>	Axel Lemmer, Daniel Schneider
Gestaltung, Satz & Layout / <i>Design</i>	Lothar Lingelbach, Laura Salewski
Druck / <i>Printing</i>	Druckerei Zeidler GmbH & Co. KG · Fritz-Ullmann-Straße 7 · 55252 Mainz-Kastel · www.zeidler.de
Datum / <i>Date</i>	Juni 2015

Leistungsangaben, Eigenschaften, Abbildungen, Zusammenstellungen, Abmessungen und Gewichte von Produkten können sich im Zuge der technischen Weiterentwicklung und der Anpassung an Bedürfnisse unserer Kunden ohne Verpflichtung oder vorherige Mitteilung ändern. Es besteht keine Verpflichtung bereits gelieferte Produkte entsprechend zu verändern. Die Herausnahme von Artikeln aus unserem Lieferprogramm behalten wir uns vor. Vertrieb nur über den Fachhandel. Irrtum und Druckfehler sowie Farbabweichungen vorbehalten. © 2015 PROJAHN Präzisionswerkzeuge GmbH Deutschland. Weitere Informationen erhalten Sie unter www.projahn.de

Performance specifications, features, pictures, lists, dimensions and weight of products may change in the course of technical development and adapt to our customers' needs without obligation or prior notice. There is no obligation to change earlier deliveries accordingly. The removal of items from our product range we reserve the right. Sales only through retailers. Errors and misprints, as well as color variations we reserve the right. © 2015 PROJAHN Präzisionswerkzeuge GmbH Germany. Further information you will find at www.projahn.de

PROJAHN Handwerkzeuge-Programm

PROJAHN Program Hand Tools

Sehr geehrter Kunde,

Vor Ihnen liegt die 12. Ausgabe des PROJAHN-Kataloges. In 2015 bieten wir Ihnen mit zwei neuen Katalogen die aktuelle Übersicht über das gesamte Sortiment an Präzisionswerkzeugen und Handwerkzeugen aus dem Hause PROJAHN.

Die große Bandbreite an Artikeln wird aber nur dadurch für Sie zu einem Mehrwert, dass Sie sich auf eine schnelle und zuverlässige Lieferung verlassen können. PROJAHN verfügt über ein großes Zentrallager in hervorragender Lage bei Frankfurt, mit ausgezeichneter Infrastruktur im Zentrum Europas. Modernste logistische Prozesse machen es möglich, dass fast alle Katalogartikel innerhalb eines Tages für Sie verfügbar sind.

In diesem neuen Katalog bieten wir Ihnen wieder eine verbesserte Übersichtlichkeit und zusätzliche Entscheidungshilfen an. Bei allen Produkten finden Sie ab sofort eine dieser drei Qualitätseinstufungen: PROFESSIONAL, PLUS oder STANDARD. Mit diesen Bezeichnungen möchten wir es Ihnen als Kunde leichter machen, die Produktqualität und den erwarteten Mehrwert je nach Anforderung und Anwendung abzugrenzen. Mehr zu diesen Bezeichnungen finden Sie auf Seite 8.

Die hohe Qualität und Vielfältigkeit der PROJAHN-Produkte ist für Sie selbstverständlich. In der aktuellen Ausgabe finden Sie im Katalog für Handwerkzeuge ab der Seite H 55 eine neue Werkzeugkofferserie, die im Bereich PROFESSIONAL den höchsten Ansprüchen gerecht wird. 14 verschiedene Werkzeug-Sortimente in Premiumqualität und ein neuer, ergonomischer Knarrengriff mit eingetragenen Design. Das alles bei 25 Jahren Garantie.

Im Bereich der Präzisionswerkzeuge befindet sich das komplette neue Sortiment an hochwertigem Zubehör für oszillierende Multitools ab der Seite P 199. Sie erhalten diese Werkzeuge mit zwei verschiedenen Aufnahmen, passend für nahezu alle Maschinen. Die Blätter sind versehen mit dem von PROJAHN bekannten Farbleitsystem für schnelles Erkennen der richtigen Anwendung. Für höchste Ansprüche an professionelle Arbeitsergebnisse.

Wir freuen uns, dass Sie sich für PROJAHN entschieden haben!

Ihr PROJAHN-Team

Dear Customer,

you see the 12th edition of the PROJAHN catalogue in front of you. In 2015 we are offering 2 new catalogues that gives overview about the entire range of precision tools and hand tools currently offered by PROJAHN.

Our wide range of products have added value due to our extremely fast and reliable delivery process. PROJAHN has a large central warehouse located in Frankfurt, which can utilize the excellent infrastructure of central Europe. State of the art logistics systems make it possible for almost any item in our catalog to be available for you within only one day.

In this new catalogue, we offer improved clarity and additional support throughout the decision making process. All products can now be found in one of these three classifications: PROFESSIONAL, PLUS, or STANDARD. Using these designations, we hope to make it easier for the customer to distinguish the product quality and the expected added value, depending on the requirements and application of the product. Learn more about these product designations on page 8.

The high quality and wide range of products offered by PROJAHN is clear. In this issue of our catalogue, check out our new tool box series on page H 55. It will be a part of our professional line, and will meet the highest standards. We are offering 14 different premium quality tool sets, as well as a brand new ergonomic ratchet handle with a registered design. All of this comes with a 25 year warranty.

In the field of precision tools, check out our all new series of high quality accessories for oscillating multi-tools on page P 199. With these tools, you get two different mounting systems, making them suitable for nearly all machines. The blades provided utilize the well-known PROJAHN color coding system for rapid recognition of the correct application. All of this contributes to providing you with professional work results.

Thank you for choosing PROJAHN!

Your PROJAHN-Team

Word cloud terms include: Marke & Werte, Brand & Values, Service & Partnerschaft, Service & Commercial Partnership, Individueller Marketingservice, Sales-boosting Product Portfolio, Personal Support, Immediate Delivery, Individual Marketing Service, Quality, Reliability, Persönliche Betreuung, Sofortige Lieferung, E-Commerce, Produktportfolio, Einzigartiges, nexmart, Zuverlässigkeit, BMEcat, and QR code.

PROJAHN Präzisionswerkzeuge GmbH

63128 Dietzenbach · Deutschland/Germany · Fon +49 (0) 60 74 / 6 96 66-66 · Fax +49 (0) 60 74 / 6 96 66-99 · verkauf@projahn.de · sales@projahn.de · www.projahn.de
KOSTENLOSE/FREE* Fax-Hotline 0 800 / 22 44 888 * aus dem deutschen Festnetz, Handytarife können abweichen / * from the German fixed network, Mobile phone rates may vary.

Qualität – Service – Zuverlässigkeit

Quality – Service – Reliability



Nachhaltigkeit

Sustainability

PROJAHN hat eine klare Philosophie: Nachhaltigkeit und Kontinuität in der Zusammenarbeit mit Kunden, Lieferanten und Mitarbeitern. Davon profitieren alle. Denn nur durch langfristiges Engagement auf allen Ebenen findet eine starke und enge Bindung statt.

PROJAHN's philosophy: Sustainability and continuity in collaborations with customers, suppliers and employees to generate benefits for all. Only long-term commitment at all levels facilitates close and strong relationships.

Zuverlässigkeit

Reliability

Zuverlässigkeit ist die Grundlage für langfristige Partnerschaften. Genauso wie Ihr Kunde sich auf Sie verlässt, können Sie sich auf PROJAHN verlassen. Bestellungen werden sofort ausgeführt. In der Regel wird Ihre Ware am Tag Ihrer Bestellung versandt. PROJAHN-Kunden können dabei sicher sein, eine gleichbleibend hohe Qualität geliefert zu bekommen. Sie wissen, dass Sie sich auf uns verlassen können!

Reliability is the basis for long-term partnerships. Just as your customer relies on you, you can rely on PROJAHN. Orders will be processed immediately. Usually, the goods will even be dispatched on the same day you placed the order. Furthermore, PROJAHN customers can count on getting goods in a consistently high quality. You know, you can rely on us!

Kompetenz

Expertise

PROJAHN verbindet umfangreiches Produkt-Know-how in einem einzigartigen Sortiment. Für Sie als PROJAHN-Kunde heißt das: Nur die besten Produkte finden Eingang in das breite Produktportfolio für Handwerk und Industrie. Profitieren Sie von dieser Produkt-Bandbreite durch einfache Beschaffungswege bei gleichzeitig konsistenter Qualität und hoher Kompetenz.

PROJAHN combines extensive product know-how with a unique product range. As a PROJAHN customer this means for you: Only the best products will be included into our large portfolio for craft and industry. Benefit from our large product range through easy procurement routes combined with constant quality and high expertise.

Persönliche Betreuung

Personal Support

Eine starke Verbindung zwischen Kunden und Lieferanten wird besonders durch persönliche Betreuung gewährleistet. Das PROJAHN-Team steht für Kontinuität in den persönlichen Kontakten. Sie können sich auf Ihren Partner PROJAHN verlassen.

Personal support ensures a strong alliance between customer and supplier. The PROJAHN team stands for consistency in personal contacts. You know whom to turn to – be it the field staff or the office staff. And you can rely on your contact partners.

Sofortige Lieferung

Immediate Delivery

PROJAHN hält nahezu alle im Katalog aufgeführten Artikel in ausreichender Menge im Logistikzentrum in Deutschland vor. Vom kleinsten Bohrer bis zum größten Werkstattwagen. Für Sie als Kunde heißt das: Sie erhalten fast jeden Artikel aus dem umfangreichen PROJAHN-Sortiment innerhalb von 24 Stunden!

Almost all of PROJAHN's articles which are listed in the catalogue are available in stock at the logistics center in Germany: from the smallest drill bit to the largest roller cabinet. This means for you as specialized dealer: You are able to supply your customers on short notice with the requested tools, even without having high stocks of your own.

Marketingservice

Customized Marketing Support

PROJAHN bietet Ihnen mit der Marketing-Serviceabteilung professionelle Lösungen zu Fragen der Kommunikation: Der vorliegende Katalog zum Beispiel ist nach den Wünschen unserer Partner besonders übersichtlich gestaltet, damit unsere Kunden das finden, was Sie benötigen!

PROJAHN's Marketing Support Department offers you professional communication and marketing: e.g. the new catalogue – which you just hold in your hands – is designed and optimized for ease of use corresponded to the feedback of our partners. So our customers don't spend long time to search – they easily find what they need.

Innovationen

Innovations

PROJAHN verfügt über ein großes Kunden- und Lieferantennetzwerk. Die tägliche Arbeit führt häufig zu neuen und besseren Ideen, um innovative Lösungen zu entwickeln. Gemeinsam mit unseren Partnern entstehen daraus professionelle Werkzeuge, die die Arbeit erleichtern, effizienter und effektiver machen.

PROJAHN maintains an extensive customer and supplier network. Daily work often inspires us with new and better ideas, to come up with innovative product solutions. In cooperation with suppliers, we use these ideas to develop professional tools that make daily work easier increasing performance as well as effectiveness.

Qualität

Quality

PROJAHN beliefert professionelle Partner, deren Kundschaft aus Handwerk, Industrie und Gewerbe kommt. Der Qualitätsanspruch unserer Kunden ist hoch. Bei täglichem Einsatz müssen die Werkzeuge wertbeständig sein und stabil funktionieren. Nur mit guten Werkzeugen kann gute Arbeit geleistet werden. Wir liefern professionelle Qualität für professionelle Anwender. Dafür steht PROJAHN.

PROJAHN supplies professional partners from craft, industry and commerce. Our customers ask for high-quality tools. In daily use, tools have to be durable and function reliably. Because only good tools enable you to do a good job! Hence, we offer professional quality for professional users. That is what PROJAHN stands for.

Einzigtiges Produktportfolio

Sales-boosting Product Portfolio

Handwerkzeuge und Präzisionswerkzeuge werden täglich von jedem Handwerker und in der Industrie benötigt. PROJAHN bietet ein sowohl breites als auch tiefes Sortiment in beiden Bereichen, wie kein anderer Anbieter. Profitieren Sie von Synergien und optimierten Beschaffungswegen. Überzeugen Sie sich von der Leistungsfähigkeit eines einzigartigen Produktsortiments.

Hand and precision tools are used by craftsman and in industrial processes on a daily basis. Like no other provider, PROJAHN offers you a broad as well as deep product range out of both product fields. Benefit from synergies and optimized procurement routes. Convince yourself of the efficiency of our unique product range.

Qualität – Service – Zuverlässigkeit

Quality – Service – Reliability



Nachhaltigkeit Experience
Flexibilität Image Tradition
Kundennähe Qualität Sustainability
Individuality Erscheinungsbild Flexibility
Confidence **Zuverlässigkeit**
Kompetenz Reliability
Expertise Vertrauen Quality Customer Focus Erfahrung
Tradition Individualität

MARKE & WERTE
BRAND & VALUES



SERVICE & PARTNERSCHAFT
SERVICE & COMMERCIAL PARTNERSHIP

Persönliche Betreuung Professionelle Beratung
Flexibilität Customer Relationship Personal Support Produktschulungen Online-Competence
E-Commerce nexmart
Lieferung zum Wunschtermin POS-Material **Sofortige Lieferung** Online-Kompetenz Delivery on Customer Request
BME cat Flexibility nextmart 24/7 Service BME cat
Individueller Marketingservice Beziehungsmangement
Professional Support Customized Marketing Support
Product Training immer erreichbar POS-Material



Produktweiterentwicklung **Neuheiten**
Innovationen New Products
Exklusivität Innovations Deep Range of Products
Know-how Continuous Product Development Featured Articles
Einzigartiges **Produktportfolio** Quality Management
Sortimentsbreite Sales-boosting Product Portfolio
Qualität Know-how
Quality Sonderartikel Large Product Range
Sortimentsbreite

PRODUKTE & INNOVATIONEN
PRODUCTS & INNOVATIONS





Profi-Qualität

Professional Quality

- ▶ **Höchstes Qualitätsniveau für anspruchsvolle Anwender**
- ▶ **Präzision und Belastbarkeit weit über DIN-/ISO-Normen**
- ▶ **Ergonomisch optimiertes Kofferdesign – 2K-Koffergriff und klar strukturierte Anordnung der Werkzeuge**
- ▶ **Optimiert auf Langlebigkeit für höchste Ansprüche**
- ▶ *Highest level of quality for demanding users*
- ▶ *Precision and durability far beyond DIN/ISO standards*
- ▶ *Ergonomically optimized design – 2K-handle and clearly structured arrangement of the tools*
- ▶ *Optimized for durability for highest demands*

Einzigartiges Produktportfolio

Unique Product Range

- ▶ **Breites Produktsortiment für verschiedenste Anwendungen**
- ▶ **14 professionelle Werkzeugkoffer optimiert für individuelle Ansprüche**
- ▶ **Innovative, zukunftsorientierte Werkzeugzusammenstellung**
- ▶ *Wide product range enables universal use*
- ▶ *14 professional tool sets optimized for individual requirements*
- ▶ *Innovative and future-oriented assortment of tools*



Exklusive Persönlichkeit

Exclusive Personality

- ▶ **Hochwertige, ausdrucksstarke Premium-Optik**
- ▶ **Langlebige und stabile Design-Metallverschlüsse**
- ▶ **Werkzeuge passgenau eingebettet in Schaumeinlagen mit attraktiver metallischer Oberflächenoptik**
- ▶ *High-quality, expressive premium-look*
- ▶ *Durable and stable design metal locks*
- ▶ *Tools perfectly embedded in foam insert with attractive metallic surface appearance*



Leistungstarker Service

Powerful Support

- ▶ **PROJAHN Qualitätsversprechen – 25 Jahre Garantie¹**
- ▶ **Alle Einzelteile problemlos nachbestellbar**
- ▶ **Inklusive Servicezertifikat**
- ▶ **Qualifizierte Produktberatung**
- ▶ *PROJAHN's promise of quality – 25 years warranty¹*
- ▶ *All individual parts easily orderable*
- ▶ *Including certificate of service*
- ▶ *Qualified product advice*



Ab Seite / From Page

H 64

¹ Entsprechend unserer allgemeinen Garantiebedingungen
² According to our general warranty conditions



Ergonomisches Design

Ergonomic Design

- ▶ **Sicherer Halt und ermüdungsfreies Arbeiten durch ergonomisch an die Hand angepasste Griffform**
- ▶ **2-Komponentenmaterial – bruchsicher, stabiler Kern und griffige Ummantelung mit hoher Rutschhemmung**
- ▶ **Hoher Abgleitschutz durch spezielle Daumenmulden**
- ▶ **Geringere Belastung für Gelenke bei gleichzeitig höherem Drehmoment**
- ▶ **Leichte Einhandbedienung durch Schnelllöseknopf und Richtungsumschalter**
- ▶ *Secure grip and fatigue-free working due to ergonomically to the hand designed ratchet handle*
- ▶ *Two-component material – robust core combined with an ergonomic, slip-resistant surface*
- ▶ *High slip protection due to specially adapted thumb grips*
- ▶ *Less strain on joints combined with a higher torque*
- ▶ *Easy one-handed operation because of quick-release button and direction lever*

**EINGETRAGENES
DESIGN**

REGISTERED DESIGN



Profi-Qualität

Professional Quality

- ▶ **Höchstes Qualitätsniveau für anspruchsvolle Anwender**
- ▶ **Präzision und Belastbarkeit weit über DIN-/ISO-Normen**
- ▶ **Hält extremen Drehmomenten bis 650 Nm stand²**
- ▶ **Leichtgängiger, hochpräziser Knarrenmechanismus**
- ▶ **Hohe Öl- und Säurebeständigkeit**
- ▶ *Highest level of quality for demanding users*
- ▶ *Precision and durability far beyond DIN/ISO standards*
- ▶ *Withstands extreme torques up to 650 Nm⁽²⁾*
- ▶ *Smooth-running, high-precision ratchet mechanism*
- ▶ *High oil and acid resistance*



Leistungstarker Service

Powerful Support

- ▶ **PROJAHN Qualitätsversprechen – 25 Jahre Garantie¹**
- ▶ **Schneller Reparaturservice im Garantiefall**
- ▶ *PROJAHN's promise of quality – 25 years warranty¹*
- ▶ *Fast repair service during warranty time*



¹ Entsprechend unserer allgemeinen Garantiebedingungen / ¹ According to our general warranty conditions
² 1/2" PROJAHN-Umschaltknarre 39012900 / ² PROJAHN ratchet handle 39012900



SPACELine Werkstattwagen

SPACELine Roller Cabinet

Artikel-Gruppe/Article-Group: 170

Dieses Produkt finden Sie im Katalog auf Seite **H 17, H 18** /
You find this product in the catalog on page **H 17, H 18**

NEU/NEW



Werkzeugkoffer & Werkzeugtasche

Tool Case & Tool Bag

Artikel-Gruppe/Article-Group: 113

Diese Produkte finden Sie im Katalog auf Seite **H 89, H 96** /
You find this products in the catalog on page **H 89, H 96**

NEU/NEW



Kraftknarren-Steckschlüsselkoffer

Power Ratchet Socket Set

Artikel-Gruppe/Article-Group: 110

Dieses Produkt finden Sie im Katalog auf Seite **H 83** /
You find this product in the catalog on page **H 83**

NEU/NEW



Mini-Steckschlüssel- und Bit-Box

Mini Socket Set and Bit Box

Artikel-Gruppe/Article-Group: 110

Dieses Produkt finden Sie im Katalog auf Seite **H 81** /
You find this product in the catalog on page **H 81**

NEU/NEW



Color-Bit-Box

Color Bit Box

Artikel-Gruppe/Article-Group: 132

Dieses Produkt finden Sie im Katalog auf Seite **H 184** /
You find this product in the catalog on page **H 184**

NEU/NEW



VDE Werkzeug-Sets

VDE Electrical Tools

Artikel-Gruppe/Article-Group: 145/113

Diese Produkte finden Sie im Katalog auf Seite **H 202** /
You find this products in the catalog on page **H 202**



NEU/NEW

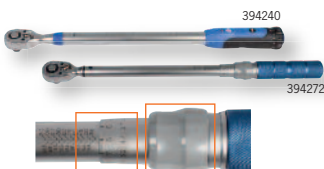

TORQUE-PROFI Drehmomentschlüssel

PROFI TORQUE-Wrenches

Artikel-Gruppe/Article-Group: 121

Diese Produkte finden Sie im Katalog auf Seite **H 124, H 125** /
You find this products in the catalog on page **H 124, H 125**

NEU/NEW



DOLPHIN Ringgabelschlüssel

DOLPHIN Combination Wrenches

Artikel-Gruppe/Article-Group: 123

Dieses Produkt finden Sie im Katalog auf Seite **H 146** /
You find this product in the catalog on page **H 146**

NEU/NEW

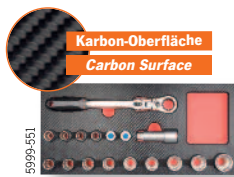

PROForm-Werkzeugeinlagen

PROForm Tool Inlays

Artikel-Gruppe/Article-Group: 171

Diese Produkte finden Sie im Katalog auf den Seiten **H 36 - H 52** /
You find this products in the catalog from page **H 36 - H 52**

NEU/NEW



ClickTech Ratschen-Ringgabelschlüssel

ClickTech Ratchet Combination Wrench

Artikel-Gruppe/Article-Group: 123

Dieses Produkt finden Sie im Katalog auf Seite **H 146** /
You find this product in the catalog on page **H 146**

NEU/NEW

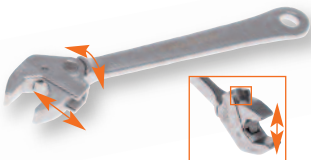

Automatischer Rollgabelschlüssel

Automatic Adjustable Wrench

Artikel-Gruppe/Article-Group: 123

Dieses Produkt finden Sie im Katalog auf Seite **H 150** /
You find this product in the catalog on page **H 150**

NEU/NEW



PROLUMAX Power-LED-Taschenlampen

PROLUMAX Power LED Flashlight

Artikel-Gruppe/Article-Group: 184

Diese Produkte finden Sie im Katalog auf den Seiten **H 227, H 228** /
You find this products in the catalog on page **H 227, H 228**

NEU/NEW



4-in1 Gerüstbauerschlüssel

4-in1 Constuction Wrench

Artikel-Gruppe/Article-Group: 123

Dieses Produkt finden Sie im Katalog auf Seite **H 151** /
You find this product in the catalog on page **H 151**

NEU/NEW

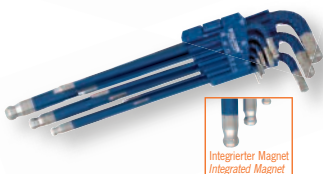

BlueEdition Winkelstiftschlüssel

BlueEdition Ball Point Hex Key

Artikel-Gruppe/Article-Group: 141

Dieses Produkt finden Sie im Katalog auf Seite **H 208** /
You find this product in the catalog on page **H 208**

NEU/NEW

Sehr geehrter Kunde, PROJAHN liefert Ihnen stets eine gleichbleibend hohe Qualität. Um Ihnen die Suche nach dem für Ihre Anforderungen optimalen Werkzeug so einfach wie möglich zu machen, finden Sie über jedem Produkt das PROJAHN-Qualitätssiegel. Folgende Qualitätsstufen gliedern zukünftig das gesamte PROJAHN-Sortiment:

Dear Customer, PROJAHN always provides you with consistently high quality. To make the search for the optimal tool for your needs as easy as possible, you find the PROJAHN Quality Seal on each product. The following grades are dividing the entire PROJAHN range:

Höchste Qualitätsstufe / Highest Quality Level:

PROFESSIONAL PLUS STANDARD

Mittlere Qualitätsstufe / Medium Quality Level:

PROFESSIONAL **PLUS** STANDARD

Standard Qualitätsstufe / Standard Quality Level:

PROFESSIONAL PLUS **STANDARD**

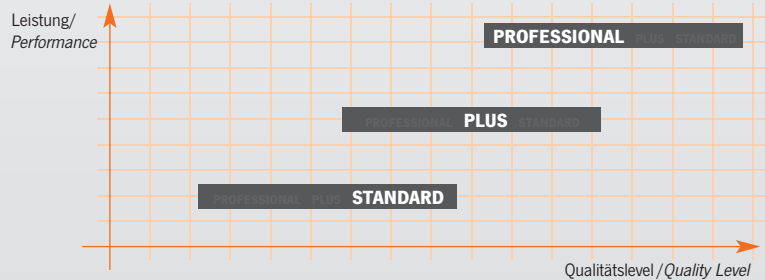
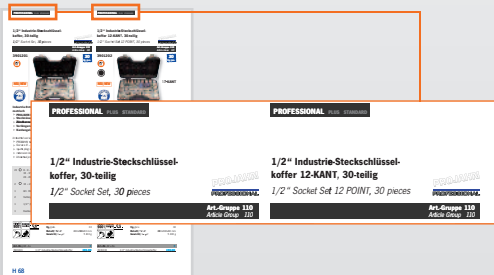

PROFESSIONAL

- ▶ Höchstes Qualitätsniveau für ausgezeichnete Präzision
- ▶ Übertrifft DIN- und ISO-Normen
- ▶ Für härteste Anwendungen bei geringem Verschleiß
- ▶ Sehr lange Lebensdauer
- ▶ Hochwertigste Materialien, professionelles Oberflächen-Finish
- ▶ Kompromisslose Qualität für höchste Ansprüche

PLUS

- ▶ Sehr hohes Qualitätsniveau für präzises Arbeiten
- ▶ Qualität über DIN- und ISO-Normen
- ▶ Werkzeuge für schwierige Anforderungen
- ▶ Für problemlösungsorientierte Anwender
- ▶ Hochwertige Herstellung, ergonomisches Design

STANDARD

- ▶ Gute Markenqualität
- ▶ Sehr attraktiver Preis für Profi-Niveau
- ▶ Qualität für alle Standard-Anwendungen

PROFESSIONAL

- ▶ Highest level of quality for excellent precision
- ▶ Exceeds DIN and ISO standards
- ▶ For the hardest applications by low wear
- ▶ Very long life time
- ▶ High-quality materials, professional finish
- ▶ Uncompromising quality for highest demands

PLUS

- ▶ Very high level of quality for highest precision
- ▶ Quality higher than DIN and ISO standards
- ▶ Tools for difficult requirements
- ▶ For problem-solving users
- ▶ High-quality manufacturing, ergonomic design

STANDARD

- ▶ Good brand quality
- ▶ Attractive price-performance ratio
- ▶ Quality for all standard applications



Werkstattwagen & Zubehör

Roller Cabinets & Accessories



Sätze, Einzelteile und Drehmomentschlüssel

Socket Sets, Accessories and Torque Wrenches



Schraubenschlüssel

Wrenches



Bit-Programm

Bits



Schraubendreher & Winkelstiftschlüssel

Screwdriver & Hex Keys



Zangen

Pliers



Taschenlampen & Arbeitsleuchten

Flash Lights & Working Lamps



Sonstige Werkzeuge

Other Tools



An diesen Zeichen erkennt man die gute PROJAHN-Qualität

You will recognize the good PROJAHN quality by these symbols

► Produktion nach DIN ISO 9001:

Unsere Produktionsstätten sind nach DIN ISO 9001 zertifiziert. Das ist die Basis unserer Qualitätsphilosophie.

► Stahl der höchsten Güteklasse:

Unsere Werkzeuge werden aus qualitativ hochwertigen Chrom-Vanadium- und S2-Stählen gefertigt. Damit ist sichergestellt, daß sämtliche DIN- und ANSI-Spezifikationen weit überschritten werden.

► Gute Werkzeuge sind für uns Ehrensache. Garantiert.

► Alles im Griff:

Optimale Eigenschaften des Griffes durch die Verwendung eines speziellen 'gummiartigen' Materials (TPE*). Im höchsten Maß Säure- und Ölbeständig. Dies garantiert eine lange Lebensdauer und gute Griffigkeit.

*Thermoplastisches Elastomer

► Auch auf den Koffer kommt es an:

Unsere PE-Koffer sind robust und alltagstauglich. Da kann es schon mal etwas ruppiger zugehen. Unsere Koffer bleiben stabil.

► Eingetragene Warenzeichen

PHILLIPS®, POZIDRIV®, TRIWING®, TORQ® sind eingetragene Markenzeichen der Firma Phillips Screw Co. TORX®, TAMPER TORX® sind eingetragene Markenzeichen der Firma Camcar/Textron, Texas. XZN® ist eingetragenes Markenzeichen der Firma Bauer-Schaurte. RIBE® ist eingetragenes Markenzeichen der Firma Richard Berger. ASSY®, SIT® sind eingetragene Markenzeichen der Firma Adolf Würth GmbH. MultiFit, TOP-CLASS, PROForm, PROMobil, PROline sind eingetragene Markenzeichen der Firma PROJAHN Präzisionswerkzeuge GmbH.

► Größenangaben

1/4" = 6,35 mm | 3/8" = 9,52 mm | 1/2" = 12,70 mm
3/4" = 19,05 mm | 1" = 25,40 mm

DIN ISO
9001

CHROM
VANADIUM



► Manufacture in Accordance with DIN ISO 9001:

Our production centres are certified in accordance with DIN ISO 9001. This is the basis of our quality philosophy.

► Steel of the Highest Quality Standard:

Our tools are manufactured from high quality Chrome Vanadium and S2 steel. This ensures, that all DIN and ANSI specifications are well exceeded.

► Good tools are a matter of honor for us. Guaranteed.

► Everything in Your Hand:

Optimal features of the handle due to the special 'rubber like' material (TPE) used. Resistant to acid and oil to the highest degree. This guarantees a long service life and a good grip. *Thermoplastic elastomer*

► The case matters:

Our PE cases are robust and suitable for the working day. Things can become a bit rough sometimes. Our cases stay in shape.

► Registered Trademarks

PHILLIPS®, POZIDRIV®, TRIWING®, TORQ® are registered trademarks of the company Phillips Screw Co. TORX®, TAMPER TORX® are registered trademarks of the company Camcar/Textron. XZN® is a registered trademark of the company Bauer-Schaurte. RIBE® is a registered trademark of the company Richard Berger. ASSY®, SIT® are registered trademarks of the company Adolf Würth GmbH. MultiFit, TOP-CLASS, PROForm, PROMobil are registered trademarks of the company PROJAHN Präzisionswerkzeuge GmbH.

► Sizes

1/4" = 6,35 mm | 3/8" = 9,52 mm | 1/2" = 12,70 mm
3/4" = 19,05 mm | 1" = 25,40 mm



**Alle Module aus dem Kapitel
SYSTEMWAND finden Sie unter:**

All System Wall Racks you find at:

www.projahn.de/qr/pos/systemwand

NEU/NEW



**Alle Produkte aus dem Kapitel
WERBEMITTEL finden Sie unter:**

All Give-Aways you find at:

www.projahn.de/qr/werbemittel

Werkstattwagen & Zubehör

*Roller Cabinets
& Accessories*



PROJAHN Werkstattwagen und Zubehör – Qualität und Vielfalt

PROJAHN Roller Cabinets and Accessories – Quality and Variety

PROFESSIONAL PLUS STANDARD

6911 **PROFI Superior**

Der Premium-Profi-Werkstattwagen – Premium-Qualität im modernen und durchdachten Design

The Professional Premium Roller Cabinet - Premium Quality in Modern and Sophisticated Design

- ▶ **EXTREM LANGLEBIG und STABIL: Robuste Doppelwandkonstruktion mit 1,0 mm Materialstärke**
Excellent stability & torsional stiffness: Double wall construction with 1,0 mm material thickness
- ▶ **MULTIFUNKTIONAL: Integrierter, einklappbarer Ablagetisch**
Multi functional: Folding side table included
- ▶ **STRAPAZIERFÄHIG: Hochstabile, kugelgelagerte Schubfachauszüge**
For heavy duty: Smooth-running & durable ball bearing slides
- ▶ **HOHES FASSUNGSVERMÖGEN: 7 Schubfächer mit jeweils einer Belastbarkeit bis zu 40 kg**
High capacity: 7 drawers with a capacity of up to 40 kg each
- ▶ **EINZIGARTIG und DAUERHAFT: Öl- und säurebeständige Design-Hochglanzfelgen**
Unique and durable: Robust oil and acid-resistant design mirror finish wheels
- ▶ **PROFESSIONELL UND ZEITLOS: Modernes und durchdachtes Design**
Professional & timeless: Modern & sophisticated design
- ▶ **ERGONOMISCH: Hochstabiler und in das Gehäuse integrierter Griff**
Ergonomic: High tensile, ergonomic hand hold
- ▶ **MULTIFUNKTIONAL: In das Gehäuse integrierte Lochblechwand, weiteres Zubehör erhältlich**
Multi functional: Lots of accessories available
- ▶ **EXTREM STABIL: Gesamtbelastbarkeit bis 700 kg**
High stability: Max. overall capacity of up to 700 kg
- ▶ **HOHE ARBEITSSICHERHEIT: Schubfächer-Sicherheits-Stopp-System – nur ein Schubfach ausziehbar (BG-konform)**
High work-safety: Only-One-Drawer (OOD) system – only one drawer at a time be opened
- ▶ **HOHE SICHERHEIT: Räder mit Roll- und Drehbremse**
High safety: Rolls with full break system



Katalog-Seite/Catalogue Page
H 14 - H 16

PROFESSIONAL PLUS STANDARD

5901, 5900, 5901-50, 5901-20 **RedLine 7** **RedLine 5** **SuperBlue** **BlackLine**

Die Profi-Werkstattwagen – Profi-Qualität im hervorragenden Preis-Leistungs-Verhältnis

Professional Roller Cabinets – Professional Quality with the best Value for Money

- ▶ **LANGLEBIG und STABIL: Robuste Doppelwandkonstruktion mit 0,9 mm Materialstärke**
Excellent stability and torsional stiffness: Double wall construction with 0,9 mm material thickness
- ▶ **STRAPAZIERFÄHIG: Hochstabile, kugelgelagerte Schubfachauszüge**
For heavy duty: Smooth-running and durable ball bearing slides
- ▶ **HOHES FASSUNGSVERMÖGEN: 7 / 5 Schubfächer mit jeweils einer Belastbarkeit bis zu 40 kg**
High capacity: 7 / 5 drawers with a capacity of up to 40 kg each
- ▶ **HOHE SICHERHEIT: Räder mit Roll- und Drehbremse**
High safety: Rolls with full break system
- ▶ **STRAPAZIERFÄHIG: Öl- und säurebeständige Rollen**
Hard-wearing: Robust oil and acid-resistant castors
- ▶ **Hervorragendes PREIS-LEISTUNGS-VERHÄLTNIS: Profi Qualität, hohe Sicherheit, Langlebigkeit und umfangreiches Zubehör**
Best value for money: Professional quality, high safety and lots of accessories
- ▶ **MULTIFUNKTIONAL: Umfangreiches Zubehör**
Multifunctional: Extensive Range of accessories available
- ▶ **HOCH STABIL: Gesamtbelastbarkeit bis zu 600 kg**
High stability: Max. overall capacity of up to 600 kg
- ▶ **HOHE ARBEITSSICHERHEIT: Schubfächer-Sicherheits-Stopp-System (BG-konform)**
High work-safety: Only-One-Drawer (OOD) system – only one drawer at a time be opened
- ▶ **INDIVIDUELL: In 3 Farbkombinationen lieferbar**
Individual: Available in 3 colour-combinations



Katalog-Seite/Catalogue Page
H 19, H 21

PROJAHN Werkstattwagen und Zubehör – Qualität und Vielfalt

PROJAHN Roller Cabinets and Accessories – Quality and Variety

PROFESSIONAL PLUS STANDARD

7901-50 **SPACE**Line

NEU/NEW

Der clevere Profi-Werkstattwagen – Profi-Qualität mit cleverem Platzkonzept

The clever professional Roller Cabinet – Professional quality with a clever space concept

► **RIESIGES FASSUNGSVERMÖGEN:**
7 Schubfächer und zusätzlich 2 seitliche Türen mit diversen Staufächern

Huge capacity: 7 Drawers and additionally 2 side doors with more storage space

► **MEHR PLATZ FÜR IHRE WERKZEUGE:**
Größere Arbeits- und Ablagefläche

More Space for your tools: Larger work & shelf space

► **ORDNUNG: Mehr Übersichtlichkeit beim Arbeiten sowie beim Suchen von Werkzeugen**

Organization: More clarity while working and when searching for tools

► **EXTREM STABIL: Hohe Stabilität und Verwindungssteifigkeit**

Extremely stable: High stability and torsional stiffness

► **EINZIGARTIG und DAUERHAFT: Öl- und säurebeständige Design-Hochglanzfelgen**

Unique and durable: Sturdy oil and acid-resistant design mirror finish wheels



► **PROFESSIONELL und ZEITLOS:**
Modernes und durchdachtes Design

*Professional and timeless:
Modern and sophisticated design*

► **ERGONOMISCH: Längerer Rollenabstand erleichtert das Bewegen des Wagens**

Ergonomic: Wider axial distance facilitates the moving of the cabinet

► **EXTREM STABIL:**
Gesamtbelastbarkeit bis 500 kg

High stability: Total load up to 500 kg

► **HOHE SICHERHEIT:**
Räder mit Roll- und Drehbremse

High safety: Rolls with full break system

► **HOHE ARBEITSSICHERHEIT: Schubfächer-Sicherheits-Stopp-System – nur ein Schubfach ausziehbar (BG-konform)**

High work-safety: Only-One-Drawer (ODD) System – only one drawer at a time may be opened

Katalog-Seite / Catalogue Page
H 17 - H 18

PROFESSIONAL PLUS STANDARD

4901-50 **ECO**Blue

Der ökonomische Profi Werkstattwagen – Gute Qualität und Funktionalität zum fairen Preis!

The Economic Roller Cabinet – Good Quality and High Functionality at a Fair Price!

► **GUTE STABILITÄT:**
Robuste Wandkonstruktion mit 0,8 mm Materialstärke

Good stability: Robust wall construction with 0,8 mm material thickness

► **SOLIDE: Stabile, kugelgelagerte Schubfachauszüge**

Smooth-running and durable ball bearing slides

► **HOHE SICHERHEIT:**
Räder mit Roll- und Drehbremse

High safety: Castors with full break system

► **ANSPRECHENDES FASSUNGSVERMÖGEN:**
6 Schubfächer mit jeweils einer Belastbarkeit bis zu 30 kg

Good capacity: 6 drawers with a capacity of up to 30 kg each



► **FUNKTIONAL: Umfangreiches Zubehör**

Functional: Accessories available

► **ÖKONOMISCH:**
Gute Qualität, hohe Sicherheit und viele Funktionen zum fairen Preis

*Economic:
Good quality, high safety and functionality at a fair price*

► **STABIL:**
Gesamtbelastbarkeit bis zu 300 kg

High stability: Max. overall capacity of up to 300 kg

► **HOHE ARBEITSSICHERHEIT: Schubfächer-Sicherheits-Stopp-System – nur ein Schubfach ausziehbar (BG-konform)**

High work-safety: Only-One-Drawer (OOD) system – only one drawer at a time to be opened

Katalog-Seite / Catalogue Page
H 22

Werkstattwagen

Roller Cabinet

PROFI Superior

Art.-Gruppe 170
Article Group 170

6911 **PROFI Superior**

Der Premium-Profi-Werkstattwagen: Premium-Qualität im modernen und durchdachten Design Werkstattwagen mit 7 Schubfächern

The Professional Premium Roller Cabinet: Premium Quality in a modern and sophisticated Design
Roller cabinet, 7 drawers

- ▶ **Außerordentlich hohe Stabilität und Verwindungssteifigkeit durch Doppelwandkonstruktion**
- ▶ **7 Schubfächer (5 x 75 mm , 2 x 154 mm Höhe)**
- ▶ **Leichtgängige und langlebige, kugelgelagerte Schubfächerauszüge mit sehr hoher Belastbarkeit**
- ▶ **Durch Zentral-Sicherheits-Stopp-System max. nur ein Schubfach ausziehbar (BG-konform)**
- ▶ **Schubfächer mit Vollauszug**
- ▶ **Zentralverriegelung durch Zylinderschloss reduziert Diebstahl von Werkzeugen**
- ▶ **Robuste öl- und säurebeständige Design-Hochglanzfelgen**
- ▶ **Rollen mit Roll- und Drehbremse verhindern das Wegrollen des Werkstattwagens**
- ▶ **Inklusive ergonomisch in das Gehäuse integriertem Handgriff und Kunststoffauflagematte**
- ▶ **Mehr Funktionalität durch integrierten, einklappbaren Ablagetisch**
- ▶ **Jedes Schubfach kann mit bis zu 3 PROForm Werkzeugeinlagen individuell bestückt werden**

Weitere technische Details siehe Seite H 26
More technical data please find on page H 26

Zubehör siehe Seite H 15 - H 16, H 25
Accessories please find on page H 15 - H 16, H 25

PROForm Werkzeugeinlagen ab Seite H 36
PROForm Tool Sets find from page H 36



Anwendungsbeispiel/Exemplary of use

Material/Material:	Stahlblech, pulverbeschichtet/Steel plates, powder-coated
Konstruktion/Construction:	Doppelwandkonstruktion/Double wall construction
Materialstärke/Material Thickness:	1,0 mm
Farbe/Colour:	Blau/Blue
Abmessungen (HxBxT)/Dimensions (HxWxD):	1.012 x 794 x 484 mm
Belastbarkeit pro Schubfach/Max. Capacity per Drawer:	40 kg
Belastbarkeit insgesamt/Max. overall Capacity:	700 kg
Gewicht/Weight:	70 kg
Rollenabmessungen/Roll Dimensions:	Ø 127 x 50 mm

- ▶ *Excellent stability and torsional stiffness*
- ▶ *7 Drawers (5 x 75 mm, 2x 154 mm height)*
- ▶ *Smooth-running and durable ball bearing slides with high capacity*
- ▶ *Due to Only-One-Drawer (OOD) system –only one drawer at a time may be opened*
- ▶ *Full extension of drawers*
- ▶ *Central locking system prevents the tools*
- ▶ *Robust oil and acid-resistant design mirror finish wheels*
- ▶ *Full Break System*
- ▶ *One handhold and one folding side table included*
- ▶ *Customized assembling with up to 3 PROForm inlays*



Inklusive einklappbaren Ablagetisch
Folding Side Table included



Ergonomischer Handgriff
Ergonomic handhold



Kugelgelagerte Schubfächerauszüge
Ball Bearing Slides



Design Hochglanzfelgen
Design Mirror Finish Wheels

Art.-Nr./Art.-No.	Farbe/Colour	€
6911	Blau/Blue	

Werkstattwagen

Roller Cabinets

PROFI Superior

Art.-Gruppe 170/172/173
Article Group 170/172/173

6911-99 **PROFI Superior** XXL

Werkstattwagen mit 7 Schubfächern, ohne Bestückung, SuperiorCase-Werkzeugkoffer, Papierrollen- und Dosenhalter

Roller Cabinet with 7 drawers, empty, SuperiorCase Toolbox, Paper Roll Holder and Can Holder

Beinhaltet / Includes:



PROFI Superior

Werkstattwagen mit 7 Schubfächern, inklusive Ablagetisch ohne Bestückung, Art.-Nr. 6911

Roller cabinet with 7 drawers, one folding side table included, empty, Art.-No. 6911



PROFI Superior

SuperiorCase, mit 4 Schubfächern ohne Bestückung, Art.-Nr. 6912

Tool Box with 4 drawers empty, Art.-No. 6912



PROFI Superior

Papierrollenhalter

Art.-Nr. 6913
Paper Roll Holder
Art.-No. 6913



PROFI Superior

Dosenhalter

Art.-Nr. 6914
Can Holder,
Art.-No. 6914

Abmessungen (HxBxT)/
Dimensions (HxWxD):
1.471 x 794 x 484 mm



Anwendungsbeispiel 6911-10/
Exemplary use of 6911-10

Art.-Nr./Art.-No.	€
6911-99 Unbest./Empty	

6911-10 **PROFI Superior** XXL

Mit 290-teiliger Profi-Werkzeugbestückung

Werkstattwagen mit 7 Schubfächern, SuperiorCase-Werkzeugkoffer, Papierrollen- und Dosenhalter

Roller Cabinet with 7 drawers, SuperiorCase Toolbox, Paper Roll Holder, Can Holder and 290 pcs. Profi Tool Set included

290
tlg./pcs.

290-teilige Profi Werkzeugbestückung bestehend aus: / 290 pcs Profi Tool Set composed of:



5999-511, 5999-521, 5999-531

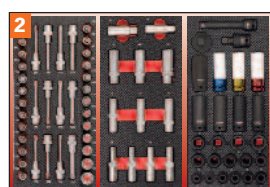

5999-191, 5999-431, 5999-151

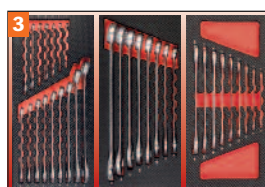

5999-011, 5999-321, 5999-021

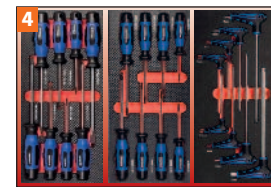

5999-065, 5999-062, 5999-341

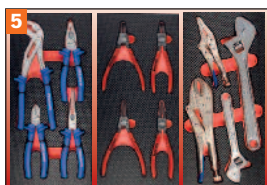

5999-082, 5999-092, 5999-171



5999-101, 5999-161, 5999-331



5999-181 (Dreifach-Einlage)

Art.-Nr./Art.-No.	€
6911-10 290-tlg./pcs.	

Weitere PROForm-Werkstatteinlagen ab Seite /
More PROForm Inlays for Roller Cabinet from Page **H 36**

Werkstattwagen – Zubehör und Ersatzteile

Roller Cabinets – Accessories and Spare Parts

PROFI Superior

Art.-Gruppe 173
Article Group 173

6912 **PROFI Superior**

SuperiorCase – Werkzeugkoffer mit Schubfächern, leer

SuperiorCase – Tool Box with 4 drawer, empty

- ▶ Der ideale Aufsatz für Ihren Profi-Superior Werkstattwagen
- ▶ Schnelle und einfache Kapazitätserweiterung vorhandener Werkstattwagen
- ▶ Mit 4 Schubfächern (Höhe 75 mm) passend für alle PROForm Werkzeugeinlagen
- ▶ Leichtgängige und langlebige, kugelgelagerte Schubfachauszüge
- ▶ Schubfächer mit Vollauszug
- ▶ Ergonomische, ins Gehäuse integrierte Handgriffe

- ▶ Fast and easy possibility to improve the capacity of your Profi-Superior roller cabinet
- ▶ 4 Drawers (75 mm Height)
- ▶ Smooth-running and durable ball bearing slides
- ▶ Full extension of drawers
- ▶ Two handholds included
- ▶ Customized assembling with up to 3 PROForm inlays



Anwendungsbispiel/Example of Use

Material/Material:	Stahlblech, pulverbeschichtet/ Steel plates, powder-coated
Materialstärke/Material Thickness:	1,0 mm
Farbe/Colour:	Blau/Blue
Abmessungen (HxBxT)/Dimensions (HxWxD):	459 x 794 x 484 mm
Belastbarkeit pro Schubfach/Max. Capacity per Drawer:	40 kg
Gewicht/Weight:	33 kg



Kugelgelagerte Schubfachauszüge
Ball Bearing Slides



Ergonomischer Handgriff
Ergonomic Handhold

Art.-Nr./Art.-No.	Farbe/Color	€
6912	Blau/Blue	

Nur passend für Werkstattwagen Art.-Nr. 6911 /
Only usable with roller cabinet Art.-No. 6911

PROFI Superior

Papierrollenhalter
Paper Roll Holder



Art.-Nr./Art.-No.	€
6913	

PROFI Superior

Dosenhalter
Can Holder



Art.-Nr./Art.-No.	€
6914	

PROFI Superior

Kugelgelagerter Schubfachauszug
Ball Bearing Drawer Pull Out

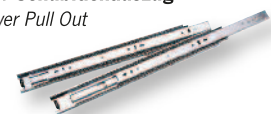

Art.-Nr./Art.-No.	€
5997-017	

PROFI Superior

Ersatzrollen
Spare Castor



Art.-Nr./Art.-No.	€
5997-009	Bockrolle/Fixed castor
5997-010	Lenkrolle/Dirigible castor

PROFI Superior

Schließzylinder mit 2 Schlüssel
Cylinder Lock and 2 Keys



Art.-Nr./Art.-No.	€
5998-XXX	
(Bitte Nr. des Zylinders angeben/Please state the cylinder number)	

PROFI Superior

Schlüssel
Key



Art.-Nr./Art.-No.	€
5996-XXX	
(Bitte Nr. des Zylinders angeben/Please state the cylinder number)	

Werkstattswagen

Roller Cabinets

SPACE Line

Art.-Gruppe 170
Article Group 170

7901-50 **SPACE Line**

Der clevere Profi-Werkstattswagen – Profi-Qualität mit cleverem Platzkonzept

The clever professional Roller Cabinet – Professional quality with a clever space concept

NEU/NEW

- ▶ **Hohe Stabilität und Verwindungssteifigkeit durch Doppelwandkonstruktion**
- ▶ **Riesiges Fassungsvermögen durch 7 Schubfächer und zusätzlich 2 seitliche Türen mit diversen Staufächern**
- ▶ **7 Schubfächer (5 x 75 mm, 2 x 154 mm Höhe)**
- ▶ **Leichtgängige und langlebige, kugelgelagerte Schubfachauszüge mit sehr hoher Belastbarkeit**
- ▶ **Durch Zentral-Sicherheits-Stopp-System max. nur ein Schubfach ausziehbar (BG-konform)**
- ▶ **Schubfächer mit Vollauszug**
- ▶ **Zentralverriegelung durch Zylinderschloss verhindert Diebstahl von Werkzeugen**
- ▶ **Alle Schubfächer und Seitentüren mit gleichem Schlüssel abschließbar**
- ▶ **Strapazierfähige, ölbeständige Design-Hochglanzräder**
- ▶ **Rollen mit Roll- und Drehbremse verhindern das Wegrollen des Werkstattwagens**
- ▶ **Inklusive Handgriff**
- ▶ **Jedes Schubfach kann mit bis zu 3 PROForm Werkzeugeinlagen individuell bestückt werden**



Anwendungsbeispiel/Example of use

Material/Material:	Stahlblech, pulverbeschichtet/Steel plates, powder-coated
Materialstärke/Material Thickness:	0,8 – 0,9 mm
Konstruktion/Construction:	Doppelwandkonstruktion/Double wall construction
Farbe/Colour:	Blau-Anthrazit/Blue-antracite
Abmessungen (HxBxT)/Dimensions (HxWxD):	990 x 910 (990 inkl. Griff) x 475 mm
Belastbarkeit pro Schubfach/Max. Capacity per Drawer:	40 kg
Belastbarkeit insgesamt/Max. overall Capacity:	500 kg
Gewicht/Weight:	72 kg
Rollenabmessungen/Roll Dimensions:	Ø 127 x 50 mm

Weitere Technische Details siehe Seite H 26
More technical data please find on page H 26

Zubehör siehe Seite H 18, H 25
Accessories please find on page H 18, H 25

PROForm Werkzeugeinlagen ab Seite H 36
PROForm Tool Sets find from page H 36

- ▶ *High stability and torsional stiffness*
- ▶ *Hugh capacity because of 7 Drawers and additionally 2 side doors*
- ▶ *7 Drawers (5 x 75 mm, 2 x 154 mm Height)*
- ▶ *Smooth-running and durable ball bearing slides with high capacity*
- ▶ *Due to Only-One-Drawer (OOD) system – only one drawer at a time may be opened*
- ▶ *Full extension of drawers*
- ▶ *Central locking system prevents against larceny of tools*
- ▶ *All Drawers and side doors lockable with only one key*
- ▶ *Robust oil and acid-resistant design mirror finish wheels*
- ▶ *Full Break System*
- ▶ *One handle included*
- ▶ *Customized assembling with up to 3 PROForm inlays*



Maximaler Stauraum
Maximum storage space



Gasdruckfedern zum Öffnen & Schließen
Gas pressure spring for opening & closing



Design Hochglanzfelgen
Design Mirror Finish Wheels



Kugelgelagerte Schubfachauszüge
Ball Bearing Slides

Art.-Nr./Art.-No.	Farbe/Color	€
7901-50	Blau-Anthrazit/Blue-anthracite	

NEU/NEW**Werkstattwagen – Zubehör und Ersatzteile***Roller Cabinets – Accessories and Spare Parts***SPACE Line****Art.-Gruppe 170**
*Article Group 170***SPACE Line****Ersatzrollen**
Spare Castor

Art.-Nr./Art.-No.	€
5997-026 Bockrolle/Fixed castor	
5997-027 Lenkrolle/Dirigible castor	

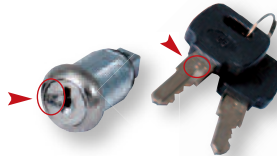
SPACE Line**Schlösser-Set**
*Cylinder Lock Set*3 Schließzylinder mit je 2 Schlüsseln
3 Cylinder Locks each with 2 Keys

Art.-Nr./Art.-No.	€
5998-001SPACE	

SPACE Line**Gasdruckfeder für Seitentür**
Gas Pressure Spring for Side Door

Art.-Nr./Art.-No.	€
5997-029	

SPACE Line**Handgriff**
Handle

Art.-Nr./Art.-No.	€
5997-028	

NEU/NEW

Werkstattwagen

Roller Cabinets

RedLine 7

SuperBlue

BlackLine

Art.-Gruppe 170
Article Group 170

5901, 5901-50, 5901-20

RedLine 7

SuperBlue

BlackLine

Die Profi-Werkstattwagen – Profi-Qualität im hervorragenden Preis-Leistungs-Verhältnis

Professional Roller Cabinets – Professional Quality with the best value for money

- ▶ **Hohe Stabilität und Verwindungssteifigkeit durch Doppelwandkonstruktion**
- ▶ **Hervorragendes Preis-Leistungs-Verhältnis**
- ▶ **7 Schubfächer (5 x 75 mm , 2 x 154 mm Höhe)**
- ▶ **Leichtgängige und langlebige, kugelgelagerte Schubfächerauszüge mit sehr hoher Belastbarkeit**
- ▶ **Durch Zentral-Sicherheits-Stopp-System max. nur ein Schubfach ausziehbar (BG-konform)**
- ▶ **Schubfächer mit Vollauszug**
- ▶ **Inklusive Handgriff**
- ▶ **In den Farben Blau, Rot und Schwarz lieferbar**
- ▶ **Umfangreiches Zubehör verfügbar**
- ▶ **Zentralverriegelung durch Zylinderschloss reduziert Diebstahl von Werkzeugen**
- ▶ **Robuste, überdimensionierte öl- und säurebeständige Rollen**
- ▶ **Rollen mit Roll- und Drehbremse verhindern das Wegrollen des Werkstattwagens**
- ▶ **Jedes Schubfach kann mit bis zu 3 PROForm Werkzeugeinlagen individuell bestückt werden**



Anwendungsbeispiel/Example of use

Material/Material:	Stahlblech, pulverbeschichtet/Steel plates, powder-coated
Materialstärke/Material Thickness:	0,9 mm
Konstruktion/Construction:	Doppelwandkonstruktion/Double wall construction
Farbe/Colour:	Blau, Rot, Schwarz/Blue, Red, Black
Abmessungen (HxBxT)/Dimensions (HxWxD):	1.000 x 676 x 459 mm
Belastbarkeit pro Schubfach/Max. Capacity per Drawer:	40 kg
Belastbarkeit insgesamt/Max. overall Capacity:	600 kg
Gewicht/Weight:	63 kg
Rollenabmessungen/Roll Dimensions:	Ø 127 x 50 mm

Weitere technische Details siehe Seite H 26
More technical data please find on page H 26

Zubehör siehe Seiten H 20, H 23 - H 25
Accessories please find on pages H 20, H 23 - H 25

PROForm Werkzeugeinlagen ab Seite H 36
PROForm Tool Sets find from page H 36

- ▶ *High stability and torsional stiffness*
- ▶ *Top value for money*
- ▶ *7 Drawers (5 x 75 mm, 2x 154 mm Height)*
- ▶ *Smooth-running and durable ball bearing slides with high capacity*
- ▶ *Due to Only-One-Drawer (OOD) system - only one drawer at a time may be opened*
- ▶ *Full extension of drawers*
- ▶ *Robust oil and acid-resistant castors*
- ▶ *Full Break System*
- ▶ *One handhold included*
- ▶ *Available in Blue, Red and Black*
- ▶ *Central locking system prevents against larceny of tools*
- ▶ *Extensive range of accessories available*
- ▶ *Customized assembling with up to 3 PROForm inlays*



Kugelgelagerte Schubfächerauszüge
Ball Bearing Slides



Robuste Doppelwandkonstruktion
Robust double wall construction



Öl- und säurebeständige Rollen
Oil and acid resistant castors



Umfangreiches Zubehör
Extensive range of accessories

Art.-Nr./Art.-No.	Farbe/Color	€
5901-50	Blau/Blue	
5901	Rot/Red	
5901-20	Schwarz/Black	

Werkstattwagen Zubehör

Accessories for Roller Cabinets

RedLine 7
SuperBlue
BlackLine
Art.-Gruppe 173
 Article Group 173

5902, 5902-50, 5902-20 **RedLine 7** **SuperBlue** **BlackLine**

Werkzeugkoffer mit 6 Schubfächern, leer

Tool Box with 6 drawers, empty

RedLine

5902

SuperBlue

5902-50

BlackLine

5902-20

- ▶ Der ideale Aufsatz für Ihren »RedLine«, »SuperBlue« oder »BlackLine« Werkstattwagen
- ▶ Schnelle und einfache Kapazitätserweiterung vorhandener Werkstattwagen
- ▶ 3 Schubfächer mit Innenmaß 75 x 269 x 568 mm
- ▶ Weitere 3 schmale Schubfächer für Kleinteile
- ▶ Herausnehmbarer Werkzeugeinsatz im Stauraum des Deckels
- ▶ Leichtgängige und langlebige, kugelgelagerte Schubfachauszüge
- ▶ Zentralverriegelung durch Schließen des Deckels
- ▶ Abschließbar durch Zylinderschloss
- ▶ Alle Schubfächer mit Vollauszug
- ▶ Inklusive 2 stabile Handgriffe
- ▶ Speziell angepasste PROForm Werkzeugeinlagen verfügbar

Werkstattwagen »BlackLine«
 und Werkzeugkoffer
 Roller Cabinet »BlackLine«
 and Tool Box



Material/Material:	Stahlblech, pulverbeschichtet/Steel plates, powder-coated
Materialstärke/Material Thickness:	0,9 mm
Farbe/Colour:	Blau, Rot, Schwarz/Blue, Red, Black
Abmessungen (HxBxT)/Dimensions (HxWxD):	378 x 660 x 307 mm
Belastbarkeit pro Schubfach/Max. Capacity per Drawer:	30 kg
Gewicht/Weight:	25,5 kg

- ▶ Ideal for putting on top of the »RedLine«, »SuperBlue« or »BlackLine« roller cabinet
- ▶ Fast and easy possibility to improve the capacity of your roller cabinet
- ▶ 3 Drawers with inside dimensions 75 x 269 x 568 mm
- ▶ 3 additional slim drawers for small parts
- ▶ Mobile tool set inlay inside of the case lid
- ▶ Smooth-running and durable ball bearing slides
- ▶ Locking all drawers by closing the top
- ▶ Full extension of drawers
- ▶ 2 handholds included
- ▶ Specific PROForm tool inlays available

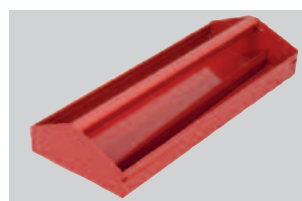

Mobiler Werkzeugeinsatz im Deckel
 Removable Tool Set Inlay



Passende Werkzeugeinlagen verfügbar
 Tool Inlays available



Weitere PROForm-Werkstatteinlagen ab Seite /
 More PROForm Inlays for Roller Cabinet from Page **H 36**

Art.-Nr./Art.-No.	Farbe/Color	€
5902	Rot/Red	
5902-50	Blau/Blue	
5902-20	Schwarz/Black	

Werkstattswagen

Roller Cabinets

RedLine 5

Art.-Gruppe 170
Article Group 170

5900 **RedLine 5**

Der kompakte Profi-Werkstattswagen – Profi-Qualität mit kompakten Abmessungen Werkstattwagen mit 5 Schubladen

The compact Roller Cabinet – Professional quality with compact dimensions, Roller Cabinet with 5 drawers

- ▶ Hohe Stabilität und Verwindungssteifigkeit durch Doppelwandkonstruktion
- ▶ Kompakte Bauhöhe von nur 845 mm
- ▶ 5 Schubfächer (3 x 75 mm, 2 x 154 mm Höhe)
- ▶ Leichtgängige und langlebige, kugelgelagerte Schubfachauszüge mit sehr hoher Belastbarkeit
- ▶ Durch Zentral-Sicherheits-Stopp-System max. nur ein Schubfach ausziehbar (BG-konform)
- ▶ Schubfächer mit Vollauszug
- ▶ Zentralverriegelung durch Zylinderschloss reduziert Diebstahl von Werkzeugen
- ▶ Robuste, überdimensionierte öl- und säurebeständige Rollen
- ▶ Rollen mit Roll- und Drehbremse verhindern das Wegrollen des Werkstattwagens
- ▶ Inklusive Handgriff
- ▶ Umfangreiches Zubehör verfügbar
- ▶ Jedes Schubfach kann mit bis zu 3 PROForm Werkzeugeinlagen individuell bestückt werden



Material/Material:	Stahlblech, pulverbeschichtet/Steel plates, powder-coated
Materialstärke/Material Thickness:	0,9 mm
Konstruktion/Construction:	Doppelwandkonstruktion/Double wall construction
Farbe/Colour:	Rot/Red
Abmessungen (HxBxD)/Dimensions (HxWxD):	845 x 676 x 459 mm
Belastbarkeit pro Schubfach/Max. Capacity per Drawer:	40 kg
Belastbarkeit insgesamt/Max. overall Capacity:	600 kg
Gewicht/Weight:	51 kg
Rollenabmessungen/Roll Dimensions:	Ø 127 x 50 mm

Weitere technische Details siehe Seite H 26
More technical data please find on page H 26

Zubehör siehe Seiten H 20, H 23 - H 25
Accessories please find on pages H 20, H 23 - H 25

PROForm Werkzeugeinlagen ab Seite H 36
PROForm Tool Sets find from page H 36

- ▶ High stability and torsional stiffness
- ▶ Compact height of 845 mm
- ▶ 5 Drawers (3 x 75 mm, 2 x 154 mm Height)
- ▶ Smooth-running and durable ball bearing slides with high capacity
- ▶ Due to Only-One-Drawer (OOD) system - only one drawer at a time may be opened
- ▶ Full extension of drawers
- ▶ Central locking system prevents against larceny of tools
- ▶ Robust oil and acid-resistant castors
- ▶ Full Break System
- ▶ One handhold included
- ▶ Extensive range of accessories available
- ▶ Customized assembling with up to 3 PROForm inlays



Kugelgelagerte Schubfachauszüge
Ball Bearing Slides



Robuste Doppelwandkonstruktion
Robust Double wall construction



Öl- und säurebeständige Rollen
Oil and acid resistant castors



Umfangreiches Zubehör
Extensive Range of accessories

Art.-Nr./Art.-No.	Farbe/Color	€
5900	Rot/Red	

Werkstattwagen

Roller Cabinets

ECOBlue

Art.-Gruppe 170
Article Group 170

4901-50 **ECOBlue**

Der ökonomische Profi-Werkstattwagen – Gute Qualität und hohe Funktionalität zum fairen Preis! Werkstattwagen mit 6 Schubfächern

The economic Roller Cabinet – Good quality and high functionality at a fair price! Roller Cabinet, 6 drawers

- ▶ **Gute Stabilität und Verwindungssteifigkeit**
- ▶ **6 Schubfächer (3 x 75 mm, 3 x 154 mm Höhe)**
- ▶ **Leichtgängige, kugelgelagerte Schubfächerauszüge**
- ▶ **Durch Zentral-Sicherheits-Stopp-System max. nur ein Schubfach ausziehbar (BG-konform)**
- ▶ **Zentralverriegelung durch Zylinderschloss**
- ▶ **Rollen: 2 x feststehend, 2 x lenkbar aus Kunststoff**
- ▶ **Rollen mit Roll- und Drehbremse verhindern das Wegrollen des Werkstattwagens**
- ▶ **Inklusive Handgriff zum einfachen Fortbewegen des Wagens und Kunststoffauflagematte**
- ▶ **Jedes Schubfach kann mit bis zu 3 PROForm-Werkzeugeinlagen individuell bestückt werden**



Material/Material:	Stahlblech, pulverbeschichtet/ Steel plates, powder-coated
Materialstärke/Material Thickness:	0,8 mm
Farbe/Colour:	Blau/Blue
Abmessungen (HxBxT)/Dimensions (HxWxD):	1.010 x 678 x 459 mm
Belastbarkeit pro Schubfach/Max. Capacity per Drawer:	30 kg
Belastbarkeit insgesamt/Max. overall Capacity:	300 kg
Gewicht/Weight:	50 kg
Rollenabmessungen/Roll Dimensions:	Ø 127 x 32 mm

- ▶ *Good stability and torsional stiffness*
- ▶ *6 Drawers (3 x 75 mm, 3 x 154 mm Height)*
- ▶ *Smooth-running ball bearing slides*
- ▶ *Due to Only-One-Drawer (OOD) system – only one drawer at a time may be opened*
- ▶ *Central locking system*
- ▶ *Castors: PVC, 2 x fixed, 2 x dirigible*
- ▶ *Full Break System*
- ▶ *One handhold included*
- ▶ *Customized assembling with up to 3 PROForm inlays*

Weitere Technische Details siehe Seite H 26
More technical data please find on page H 26

Zubehör siehe Seiten H 23 - H 25
Accessories please find on pages H 23 - H 25

PROForm Werkzeugeinlagen ab Seite H 36
PROForm Tool Sets find from page H 36



Kugelgelagerte Schubfächerauszüge
Ball Bearing Slides

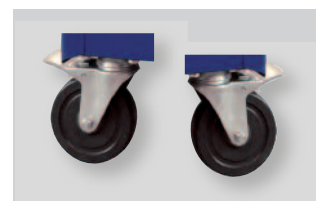

Rollen mit Roll- und Drehbremse
Full Break System

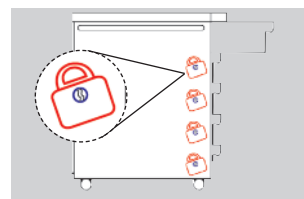

Zentralverriegelung
Central Locking System

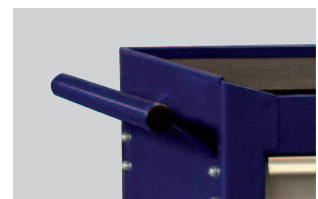

Inklusive stabilem Handgriff
Handhold Included

Art.-Nr./Art.-No.	Farbe/Color	€
4901-50	Blau/Blue	

Werkstattwagen Zubehör für »RedLine«, »SuperBlue«, »BlackLine« und »ECOBlue«

Roller Cabinet Accessories for »RedLine«, »SuperBlue«, »BlackLine« and »ECOBlue«

Art.-Gruppe 173
Article Group 173

Ablage-Tisch
Side Table

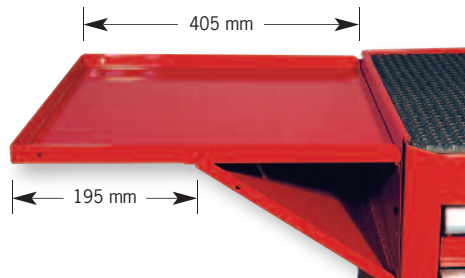

Art.-Nr./Art.-No.	Farbe/Colour	€
5907	Rot/Red	
5907-20	Schwarz/Black	
5907-50	Blau/Blue	

Arbeitsauflage aus Kunststoff
Top Table

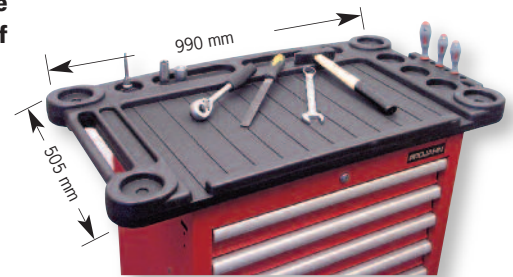

Arbeitsauflageplatte aus Holz, 15 mm stark
Wooden Top Table 15 mm

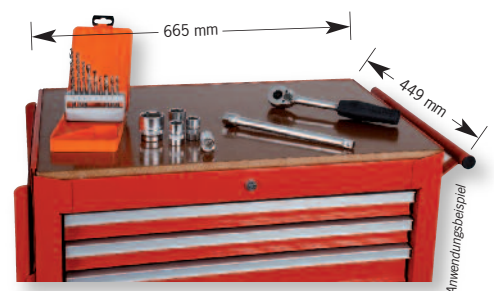

Kannen-/Dosenhalter
Can Holder

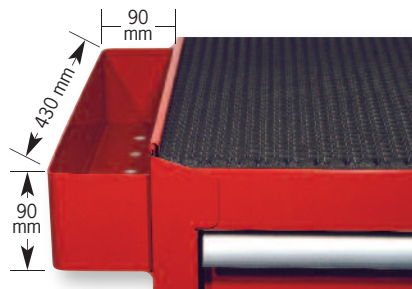

Art.-Nr./Art.-No.	Farbe/Colour	€
5908*	Rot/Red	
5908-20*	Schwarz/Black	
5908-50*	Blau/Blue	

*nicht passend für »ECOBlue«-Werkstattwagen
*not fitting »ECOBlue« Roller Cabinet

Art.-Nr./Art.-No.	Beschr./Description	€
5909	Arbeitsauflage Kunststoff/Top Table	
5921	Arbeitsauflageplatte Holz/Wooden Top Table	
5922	Ersatzauflagematte/Replacement Pad	

Magnetische Lochwand inkl. 10 Haken, 450 mm, max. 6 kg

Magnetic Tool Rack with 10 hooks, 450 mm, max. 6 kg

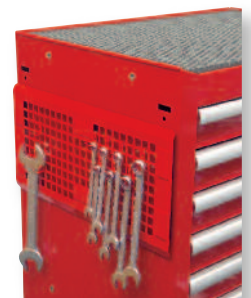

Art.-Nr./Art.-No.	tlg./pcs.	€
5912	11	
5912-10	Einzelhaken 10er Pack/Single Hooks 10 pieces	

Magnetische Universalablage
Magnetic Tray

310 x 115 x 31 mm



Art.-Nr./Art.-No.	Belastbarkeit/Loading Capacity	€
5910	max. 3,5 kg	
5911	max. 4,0 kg	

Papierkorb zu Werkstattwagen
Plastic Cask



Art.-Nr./Art.-No.	Beschr./Description	€
5913	Papierkorb/Plastic Cask	

Werkstattwagen Zubehör für »RedLine«, »SuperBlue«, »BlackLine« und »ECOBlue«

Roller Cabinet Accessories for »RedLine«, »SuperBlue«, »BlackLine« and »ECOBlue«

Art-Gruppe 173
Article Group 173

PROFESSIONAL PLUS STANDARD

5997-001

Handgriff »RedLine«

Handhold »RedLine«

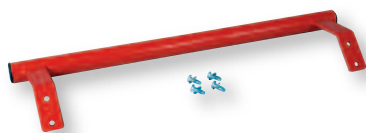

Art.-Nr./Art.-No.	Beschr./Descr.	€
5997-001	RedLine	

PROFESSIONAL PLUS STANDARD

5997-002

Handgriff »SuperBlue«/»ECOBlue«

Handhold »SuperBlue«/»ECOBlue«

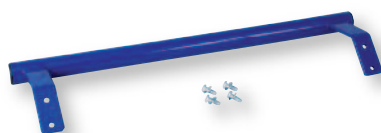

Art.-Nr./Art.-No.	Beschr./Descr.	€
5997-002	SuperBlue/ECOBlue	

PROFESSIONAL PLUS STANDARD

5997-013

Handgriff »BlackLine«

Handhold »BlackLine«

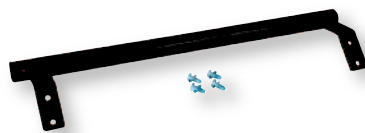

Art.-Nr./Art.-No.	Beschr./Descr.	€
5997-013	BlackLine	

PROFESSIONAL PLUS STANDARD

5997-003

Kugelgelagerter Schubfachauszug für »RedLine«, »SuperBlue«, »BlackLine« und »SpaceLine«

Ball Bearing Drawer Pullout for »RedLine«, »SuperBlue«, »BlackLine« and »SpaceLine«

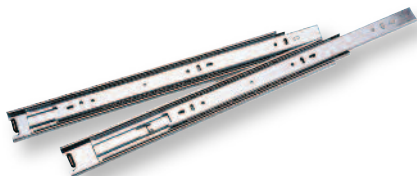

Art.-Nr./Art.-No.	Beschr./Descr.	€
5997-003	Auszug	

PROFESSIONAL PLUS STANDARD

5997-014

Kugelgelagerter Schubfachauszug für »ECOBlue«

Ball Bearing Slides for »ECOBlue«

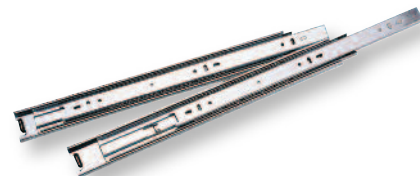

Art.-Nr./Art.-No.	Beschr./Descr.	€
5997-014	Auszug ECOBlue	

PROFESSIONAL PLUS STANDARD

5997-011 / 5997-012

Ersatzrollen für »RedLine«, »SuperBlue« und »BlackLine«

Spare Castor for »RedLine«, »SuperBlue« and »BlackLine«

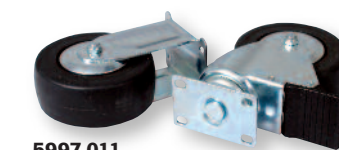

5997-011
Bockrolle starr/
fixed castor

5997-012
Lenkrolle mit
Feststellfunktion/
dirigible castor with stopper

Art.-Nr./Art.-No.	Beschr./Descr.	€
5997-011	Bockrolle/fixed castor	
5997-012	Lenkrolle/dirigible castor	

PROFESSIONAL PLUS STANDARD

5997-015 / 5997-016

Ersatzrollen für »ECOBlue«

Spare Castor for »ECOBlue«

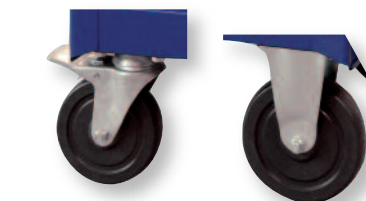

Art.-Nr./Art.-No.	Beschr./Descr.	€
5997-015	Bockrolle/fixed castor	
5997-016	Lenkrolle/dirigible castor	

5998-XXX (Bitte Nr. des Zylinders angeben)

Schließzylinder mit 2 Schlüsseln

Cylinder Lock and 2 Keys

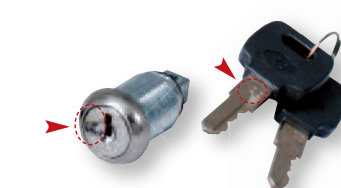

Art.-Nr./Art.-No.	Beschr./Descr.	€
5998-XXX	Schließzylinder	

(Bitte Nr. des Zylinders angeben/Please state the cylinder number)

5996-XXX (Bitte Nr. des Zylinders angeben)

Schlüssel

Key



Art.-Nr./Art.-No.	Beschr./Descr.	€
5996-XXX	Schlüssel	

(Bitte Nr. des Zylinders angeben/Please state the cylinder number)

Werkstattwagen Zubehör für alle PROJAHN Werkstattwagen

Roller Cabinet Accessories for every PROJAHN Roller Cabinet

Art.-Gruppe 173
Article Group 173

5914

Schubfachunterteiler: Basiselement
566 x 65,6 x 1 mm aus Metall
(pro Schublade 2 Stück erforderlich)
Drawer Divider of Front and Back Side
(2 pieces per drawer required)

5915

Schubfachunterteiler: gerade/längs
392 x 60 x 1,4 mm aus Metall
Drawer Divider of Straight

5916

Schubfachunterteiler „XL“
187,9 x 50 x 1,4 mm aus Metall
Drawer Divider „XL“

5917

Schubfachunterteiler „L“
149,9 x 50 x 1,4 mm aus Metall
Drawer Divider „L“

5918

Schubfachunterteiler „M“
111,9 x 50 x 1,4 mm aus Metall
Drawer Divider „M“

5919

Schubfachunterteiler „S“
79,4 x 50 x 1,4 mm aus Metall
Drawer Divider „S“

5920

Schubfachunterteiler Set
Drawer Divider Set
Inhalt/Contents:
2x Basiselement (5914)
4x Unterteiler „gerade“ (5915)
2x Unterteiler „XL“ (5916)
2x Unterteiler „L“ (5917)
3x Unterteiler „M“ (5918)
4x Unterteiler „S“ (5919)

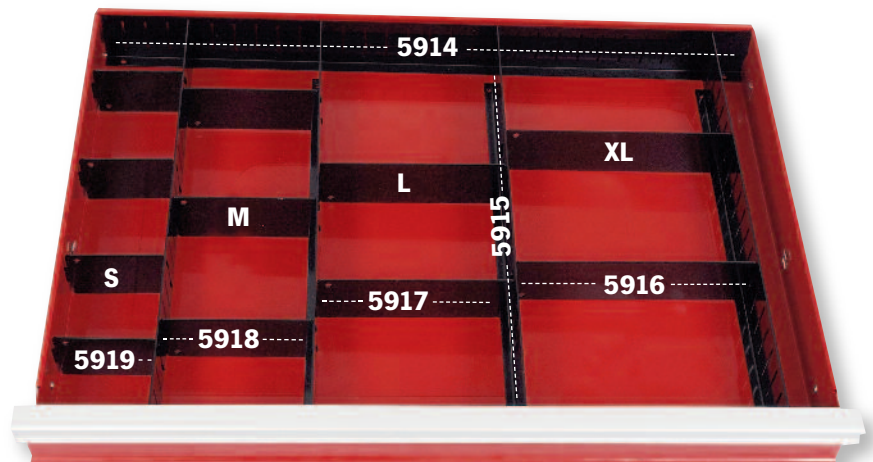

Wie in Artikel 5920 beschrieben / Similar to Art. 5920

Art.-Nr./Art.-No.	Beschr./Description	€
5914	Basis	
5915	gerade/längs	
5916	XL	
5917	L	
5918	M	
5919	S	
5920	Set	

Magnetschalen

Magnetic Trays

Mit starkem, gummiüberzogenen Dauermagneten.
Zum Aufbewahren von Kleinwerkzeugen und Kleinteilen
wie Schrauben und Muttern bei Montage und im
Garagengewerbe.
Magnetkraft bis 1200 g.

With strong, rubber protected continous magnets.
Optimal to store small tools and parts, such as screws and
nuts, at instalation jobs and in the automotive field.
Magnetic power up to 1200 g.



Art.-Nr./Art.-No.	Größe/Size	€
2950	Ø 150 mm rund/round	
2951	240 x 140 mm eckig/rectangular	

Werkstattwagen – Technische Daten

Roller Cabinets – Technical Data

6911 **PROFI Superior**

Material: Stahlblech, pulverbeschichtet
 Materialstärke: 1,0 mm
 Konstruktion: Doppelwandkonstruktion
 Farbe: Blau
 Abmessungen (HxBxT): 1.012 x 794 x 484 mm
 Anzahl Schubfächer: 7
 Höhe Schubfächer: 2 x 154, 5 x 75 mm
 Innenabm. Schubf. (BxT): 560 x 395 mm
 Belastbarkeit pro Schubfach: 40 kg
 Belastbarkeit insgesamt: 700 kg
 Gewicht: 70 kg
 Rollenabmessung (ØxB): 127 x 50 mm

Material: Steel plates, powder-coated
 Material thickness: 1,0 mm
 Construction: Double wall construction
 Colour: Blue
 Dimensions (HxWxD): 1012 x 794 x 484 mm
 Number of drawers: 7
 Height of drawers: 2 x 154 mm, 5 x 75 mm
 Inside dimensions drawers (WxD): 560 x 395 mm
 Max. Capacity per drawer: 40 kg
 Max. overall Capacity: 700 kg
 Weight: 70 kg
 Dimensions rolls (ØxB): 127 x 50 mm

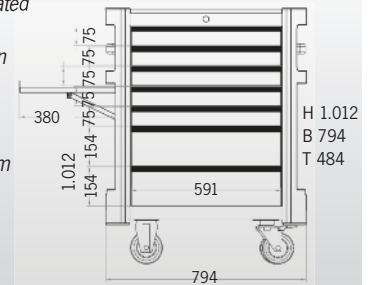

7901-50 **SPACE Line** **NEU/NEW**

Material: Stahlblech, pulverbeschichtet
 Materialstärke: 0,8 - 0,9 mm
 Konstruktion: Doppelwandkonstruktion
 Farbe: Blau/Anthrazit
 Abmessungen (HxBxT): 990 x 910 (990 inkl. Griff) x 475 mm
 Anzahl Schubfächer: 7
 Höhe Schubfächer: 2 x 154, 5 x 75 mm
 Innenabm. Schubf. (BxT): 560 x 395 mm
 Belastbarkeit pro Schubfach: 40 kg
 Belastbarkeit insgesamt: 500 kg
 Gewicht: 72 kg
 Rollenabmessung (ØxB): 127 x 50 mm

Material: Steel plates, powder-coated
 Material thickness: 0,8 - 0,9 mm
 Construction: Double wall construction
 Colour: Blue/Anthracite
 Dimensions (HxWxD): 990 x 910 (990 incl. Handle) x 475 mm
 Number of drawers: 7
 Height of drawers: 2 x 154 mm, 5 x 75 mm
 Inside dimensions drawers (WxD): 560 x 395 mm
 Max. Capacity per drawer: 40 kg
 Max. overall Capacity: 500 kg
 Weight: 72 kg
 Dimensions rolls (ØxB): 127 x 50 mm

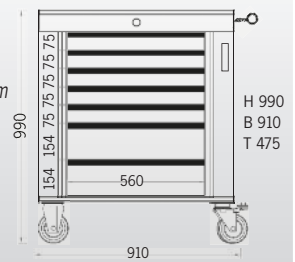

5901, 5900, 5901-50, 5901-20 **RedLine 7** **RedLine 5** **SuperBlue** **BlackLine**

Material: Stahlblech, pulverbeschichtet
 Materialstärke: 0,9 mm
 Konstruktion: Doppelwandkonstruktion
 Farben: Blau, Rot, Schwarz
 Abmessungen (HxBxT): 1.000 / 845 x 676 x 459 mm
 Anzahl Schubfächer: 7 / 5
 Höhe Schubfächer: 2 x 154, 5 / 3 x 75 mm
 Innenabm. Schubf. (BxT): 560 x 395 mm
 Belastbarkeit pro Schubfach: 40 kg
 Belastbarkeit insgesamt: 600 kg
 Gewicht: 63 kg / 51 kg
 Rollenabmessung (ØxB): 127 x 50 mm

Material: Steel plates, powder-coated
 Material thickness: 0,9 mm
 Construction: Double wall construction
 Colours: Blue, Red, Black
 Dimensions (HxWxD): 1.000 / 845 x 676 x 459 mm
 Number of drawers: 7 / 5
 Height of drawers: 2 x 154 mm, 5 / 3 x 75 mm
 Inside dimensions drawers (WxD): 560 x 395 mm
 Max. Capacity per drawer: 40 kg
 Max. overall Capacity: 600 kg
 Weight: 63 kg / 51 kg
 Dimensions rolls (ØxB): 127 x 50 mm

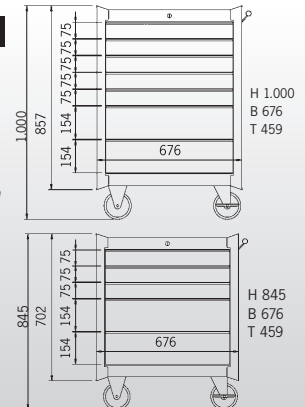

4901-50 **ECOBlue**

Material: Stahlblech, pulverbeschichtet
 Materialstärke: 0,8 mm
 Farbe: Blau
 Abmessungen (HxBxT): 1.010 x 676 x 459 mm
 Anzahl Schubfächer: 6
 Höhe Schubfächer: 3 x 154, 3 x 75 mm
 Innenabm. Schubf. (BxT): 560 x 395 mm
 Belastbarkeit pro Schubfach: 30 kg
 Belastbarkeit insgesamt: 300 kg
 Gewicht: 50 kg
 Rollenabmessung (ØxB): 127 x 32 mm

Material: Steel plates, powder-coated
 Material thickness: 0,8 mm
 Colour: Blue
 Dimensions (HxWxD): 1.010 x 676 x 459 mm
 Number of drawers: 6
 Height of drawers: 3 x 154 mm, 3 x 75 mm
 Inside dimensions drawers (WxD): 560 x 395 mm
 Max. Capacity per drawer: 30 kg
 Max. overall Capacity: 300 kg
 Weight: 50 kg
 Dimensions rolls (ØxB): 127 x 32 mm

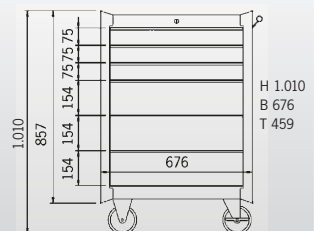

PROForm-Box – Koffersystem für PROForm Werkstattwagen-Einlagen

PROForm-Box – Cases for PROForm Inlays

Art-Gruppe 172/179
Article Group 172/179

5953

PROForm-Box 1: Mobiler Koffer für eine PROForm-Werkzeug-Einlage (395 x 186 mm)

PROForm-Box 1: Mobile Case for one PROForm Tool Inlay (395 x 186 mm)

Stellen Sie sich Ihren eigenen Werkzeugkoffer zusammen oder machen Sie Ihre Werkstattwagen-Werkzeuge noch mobiler!

Customize your own Tool Set or make your Roller Cabinet Tools available!

- ▶ **INDIVIDUELL und BEQUEM:** Konfigurieren Sie Ihren eigenen Werkzeugkoffer oder wählen Sie aus unseren Topseller-Konfigurationen
- ▶ **KOMPAKT:** Platzsparend und daher ideal für unterwegs
- ▶ **MOBIL und FLEXIBEL:** Benötigte Werkzeug-Einlage vom Werkstattwagen in die PROForm-Box umpacken und mitnehmen
- ▶ **STABIL und LANGLEBIG:** Sichere und saubere Werkzeugaufbewahrung

- ▶ *INDIVIDUAL and COMFORTABLE:* Customize your own tool set or choose from our top-seller configurations
- ▶ *COMPACT:* Space saving and therefore ideal for mobile use
- ▶ *MOBILE and FLEXIBLE:* PROForm-Box is able to fit one PROForm inlay from your roller cabinet which makes your tools mobile
- ▶ *DURABLE:* Tools are secured to be shock and jolt-proof



5953-011

PROForm-BOX mit Einlage Ringgabelschlüssel/ PROForm-BOX incl. Combination Wrench Inlay



5953-021

PROForm-BOX mit Einlage Doppelgabelschlüssel/ PROForm-BOX incl. Double Open End Wrench Inlay

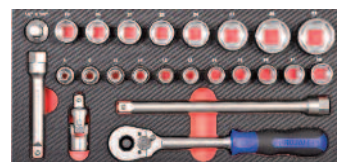

5953-131

PROForm-BOX mit Einlage 1/2" Steckschlüssel/ PROForm-BOX incl. 1/2" Socket Inlay



5953-065

PROForm-BOX mit Einl. PH-/PZ-/Schlitz-Schraubendr./PROForm-BOX incl. PH-/PZ-/Slotted Screwdriver Inlay



5953-082

PROForm-BOX mit Einlage Zangen/ PROForm-BOX incl. Pliers Inlay



5953-101

PROForm-BOX mit Einlage Schlagwerkzeuge/ PROForm-BOX incl. Hammer and Punch Inlay

Weitere PROForm-Werkstatteinlagen ab Seite /
More PROForm Inlays for Roller Cabinet from Page **H 36**

Art.-Nr./Art.-No.	Beschreibung/Description	tlg./pcs	€
5953	PROForm-Box 1 – Leerkoffer/Empty Box		
5953-011	PROForm-Box mit Einlage Ringgabelschlüssel/incl. Combination Wrench Inlay	16	
5953-021	PROForm-Box mit Einlage Doppelgabelschlüssel/incl. Double Open End Wrench Inlay	8	
5953-131	PROForm-Box mit Einlage 1/2" Steckschlüssel/incl. 1/2" Socket Inlay	24	
5953-065	PROForm-Box mit Einlage PH-/PZ-/Schlitz-Schraubendreher/incl. PH-/PZ-/Slotted Screwdriver Inlay	8	
5953-082	PROForm-Box mit Einlage Zangen/incl. Pliers Inlay	4	
5953-101	PROForm-Box mit Einlage Schlagwerkzeuge/incl. Hammer and Punch Inlay	6	

PROForm-Box – Koffersystem für PROForm Werkstattwagen-Einlagen

PROForm-Box – Cases for PROForm Inlays

Art.-Gruppe 172/179
Article Group 172/179

5954

PROForm-Box 3: Mobiler Koffer für eine PROForm-Werkzeug-Einlage (395 x 560 mm) oder drei Werkzeug-Einlagen (395 x 186 mm)

PROForm-Box 3: Mobile Case for one PROForm Tool Inlay (395 x 560 mm) or Three Tool Inlays (395 x 186 mm)

Stellen Sie sich Ihren eigenen Werkzeugkoffer zusammen oder machen Sie Ihre Werkstattwagen-Werkzeuge noch mobiler!

Customize your own Tool Set or make your Roller Cabinet Tools available!

- ▶ **INDIVIDUELL:** Konfigurieren Sie Ihren eigenen Werkzeugkoffer aus bis zu drei PROForm-Einlagen
- ▶ **BEQUEM:** Oder wählen Sie aus unseren Topseller-Konfigurationen
- ▶ **MOBIL und FLEXIBEL:** Benötigte Werkzeug-Einlage vom Werkstattwagen in die PROForm-Box umpacken und mitnehmen
- ▶ **STABIL und LANGLEBIG:** Sichere und saubere Werkzeugaufbewahrung

- ▶ *INDIVIDUAL:* Customize your own tool set from up to three PROForm inlays
- ▶ *COMFORTABLE:* Or choose from our top-seller configurations
- ▶ *MOBILE and FLEXIBLE:* PROForm-Box is able to fit up to three PROForm inlays from your roller cabinet which makes your tools mobile
- ▶ *DURABLE:* Tools are secured to be shock and jolt-proof



5954-001 - Set, 48-tgl./48 pcs.
PROForm-BOX Set bestehend aus/
composed of 5999-011 + 5999-131 + 5999-065



5954-002 - Set, 39-tgl./39 pcs.
PROForm-BOX Set bestehend aus/
composed of 5999-041 + 5999-531 + 5999-082



5954-003 - Set, 18-tgl./18 pcs.
PROForm-BOX Set bestehend aus/
composed of 5999-101 + 5999-065 + 5999-082

Weitere PROForm-Werkstatteinlagen ab Seite /
More PROForm Inlays for Roller Cabinet from Page **H 36**

Art.-Nr./Art.-No.	Beschreibung/Description	tlg./pcs	€
5954	PROForm-Box 3 – Leerkoffer/Empty Box		
5954-001	PROForm-Box Set 3 bestehend aus/composed of 5999-011 + 5999-131 + 5999-065	48	
5954-002	PROForm-Box Set 3 bestehend aus/composed of 5999-411 + 5999-531 + 5999-082	39	
5954-003	PROForm-Box Set 3 bestehend aus/composed of 5999-101 + 5999-065 + 5999-082	18	

Werkstattwagen-Bestückung für 2 Schubfächer, 67-teilig

Roller Cabinet Sets for 2 Drawers, 67 pieces

67
tlg./pcs.

Art.-Gruppe 171/172
Article Group 171/172

Wählen Sie Ihren Werkstattwagen mit Bestückung oder nur die Bestückung

Choose your Roller Cabinet with Sets
or only the sets



Legende auf Seite H 36

Art.-Nr./Art.-No.	Produkt/Product
5995-001	Bestückung 67-tlg./ Sets with 67 pcs.
6911-101	Werk. »PROFISuperior«, 7 Schubf. mit Bestückung/with Sets
7901-501	Werkstattw. »SpaceLine«, 7 Schubf. mit Bestückung/with Sets
5901-101	Werkstattw. »RedLine«, 7 Schubf. mit Bestückung/with Sets
5901-551	Werkstattw. »SuperBlue«, 7 Schubf. mit Bestückung/with Sets
5901-201	Werkstattw. »BlackLine«, 7 Schubf. mit Bestückung/with Sets
5900-101	Werkstattw. »RedLine«, 5 Schubf. mit Bestückung/with Sets
4901-501	Werkstattw. »ECOBlue«, 6 Schubf. mit Bestückung/with Sets

6911-101

Werkstattwagen »PROFISuperior« mit 7 Schubfächern, bestückt

Roller Cabinet »PROFISuperior«,
7 Drawers with Sets

7901-501

Werkstattwagen »SpaceLine« mit 7 Schubfächern, bestückt

Roller Cabinet »SpaceLine«, 7 Drawers with Sets

5901-101

Werkstattwagen »RedLine« mit 7 Schubfächern, best.

Roller Cabinet »RedLine«, 7 Drawers with Sets

5901-551

Werk. »SuperBlue« mit 7 Schubfächern, bestückt

Roller Cabinet »SuperBlue«, 7 Drawers with Sets

5901-201

Werkstattwagen »BlackLine« mit 7 Schubfächern, bestückt

Roller Cabinet »BlackLine«, 7 Drawers with Sets

5900-101

Werkstattwagen »RedLine« mit 5 Schubfächern, bestückt

Roller Cabinet »RedLine«, 5 Drawers with Sets

4901-501

Werkstattwagen »ECOBlue« mit 6 Schubfächern, bestückt

Roller Cabinet »ECOBlue«, 6 Drawers with Sets



5995-001

Bestehend aus / Composed of

5999-131 + 5999-011 + 5999-021 + 5999-082 + 5999-065 + 5999-101

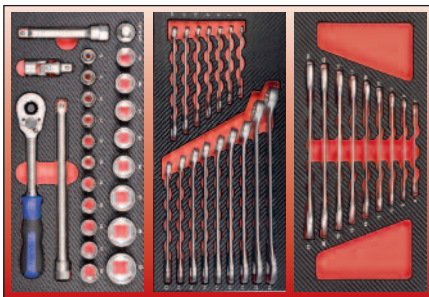

Werkstattwagen-Bestückung für 2 Schubfächer, 148-teilig

Roller Cabinet Sets for 2 Drawers, 148 pieces

148
tlg./pcs.

Art.-Gruppe 171/172
Article Group 171/172

**Wählen Sie Ihren
Werkstattwagen mit Bestückung
oder nur die Bestückung**
Choose your Roller Cabinet with Sets
or only the sets

 Legende auf Seite H 36

Art.-Nr./Art.-No.	Produkt/Product
5995-002	Bestückung 148-tlg./ Sets with 148 pcs.
6911-102	Werk. »PROFISuperior«, 7 Schubf. mit Bestückung/with Sets
7901-502	Werkstattw. »SpaceLine«, 7 Schubf. mit Bestückung/with Sets
5901-102	Werkstattw. »RedLine«, 7 Schubf. mit Bestückung/with Sets
5901-552	Werkstattw. »SuperBlue«, 7 Schubf. mit Bestückung/with Sets
5901-202	Werkstattw. »BlackLine«, 7 Schubf. mit Bestückung/with Sets
5900-102	Werkstattw. »RedLine«, 5 Schubf. mit Bestückung/with Sets
4901-502	Werkstattw. »ECOBlue«, 6 Schubf. mit Bestückung/with Sets

6911-102

**Werkstattwagen »PROFISuperior«
mit 7 Schubfächer, bestückt**
Roller Cabinet »PROFISuperior«,
7 Drawers with Sets

7901-502

**Werkstattwagen »SpaceLine«
mit 7 Schubfächern, bestückt**
Roller Cabinet »SpaceLine«, 7 Drawers with Sets

5901-102

Werkstattwagen »RedLine« mit 7 Schubfächer, best.
Roller Cabinet »RedLine«, 7 Drawers with Sets

5901-552

Werkst. »SuperBlue« mit 7 Schubfächer, bestückt
Roller Cabinet »SuperBlue«, 7 Drawers with Sets

5901-202

Werkstattwagen »BlackLine« mit 7 Schubfächer, bestückt
Roller Cabinet »BlackLine«, 7 Drawers with Sets

5900-102

Werkstattwagen »RedLine« mit 5 Schubfächer, bestückt
Roller Cabinet »RedLine«, 5 Drawers with Sets

4901-502

Werkstattwagen »ECOBlue« mit 6 Schubfächer, bestückt
Roller Cabinet »ECOBlue«, 6 Drawers with Sets



5995-002

Bestehend aus / Composed of

5999-111 + 5999-131 + 5999-191 + 5999-011 + 5999-082 + 5999-065

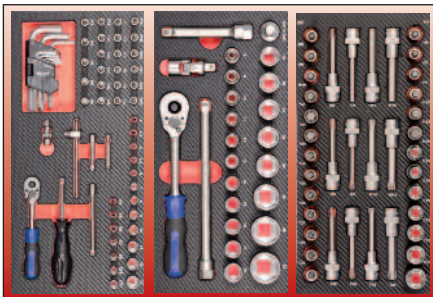

Werkstattwagen-Bestückung für 3 Schubfächer, 171-teilig

Roller Cabinet Sets for 3 Drawers, 171 pieces

171
tlg./pcs.

Art.-Gruppe 171/172
Article Group 171/172

Wählen Sie Ihren Werkstattwagen mit Bestückung oder nur die Bestückung

Choose your Roller Cabinet with Sets
or only the sets



Legende auf Seite H 36

Art.-Nr./Art.-No.	Produkt/Product
5995-011	Bestückung 171-tlg./ Sets with 171 pcs.
6911-111	Werkst. »PROFISuperior«, 7 Schubf. mit Bestückung/with Sets
7901-511	Werkstattw. »SpaceLine«, 7 Schubf. mit Bestückung/with Sets
5901-111	Werkstattw. »RedLine«, 7 Schubf. mit Bestückung/with Sets
5901-511	Werkstattw. »SuperBlue«, 7 Schubf. mit Bestückung/with Sets
5901-211	Werkstattw. »BlackLine«, 7 Schubf. mit Bestückung/with Sets
5900-111	Werkstattw. »RedLine«, 5 Schubf. mit Bestückung/with Sets
4901-511	Werkstattw. »ECOBlue«, 6 Schubf. mit Bestückung/with Sets

6911-111

Werkstattwagen »PROFISuperior« mit 7 Schubfächern, bestückt

Roller Cabinet »PROFISuperior«,
7 Drawers with Sets

7901-511

Werkstattwagen »SpaceLine« mit 7 Schubfächern, bestückt

Roller Cabinet »SpaceLine«, 7 Drawers with Sets

5901-111

Werkstattwagen »RedLine« mit 7 Schubfächern, best.

Roller Cabinet »RedLine«, 7 Drawers with Sets

5901-511

Werkst. »SuperBlue« mit 7 Schubfächern, bestückt

Roller Cabinet »SuperBlue«, 7 Drawers with Sets

5901-211

Werkstattwagen »BlackLine« mit 7 Schubfächern, bestückt

Roller Cabinet »BlackLine«, 7 Drawers with Sets

5900-111

Werkstattwagen »RedLine« mit 5 Schubfächern, bestückt

Roller Cabinet »RedLine«, 5 Drawers with Sets

4901-511

Werkstattwagen »ECOBlue« mit 6 Schubfächern, bestückt

Roller Cabinet »ECOBlue«, 6 Drawers with Sets



5995-011

Bestehend aus / Composed of

5999-111 + 5999-131 + 5999-191 + 5999-011 + 5999-321 + 5999-021 +
5999-082 + 5999-065 + 5999-101

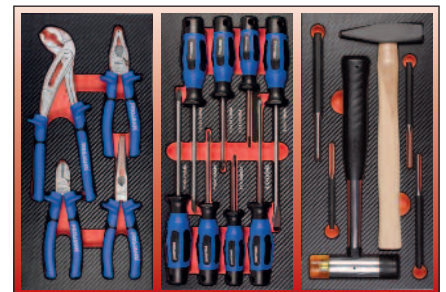
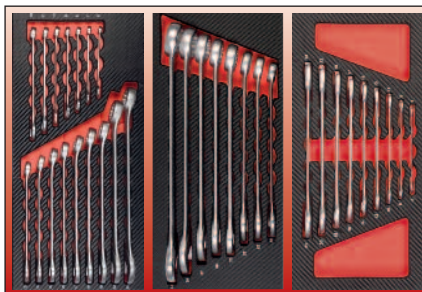
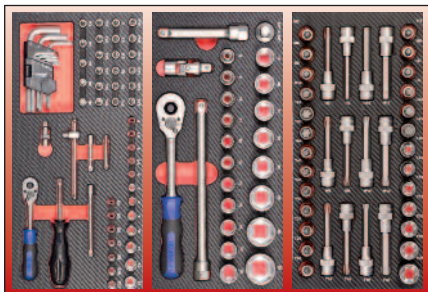

Werkstattwagen-Bestückung für 4 Schubfächern, 179-teilig

Roller Cabinet Sets for 4 Drawers, 179 pieces

179
tlg./pcs.

Art.-Gruppe 171/172
Article Group 171/172

Wählen Sie Ihren

**Werkstattwagen mit Bestückung
oder nur die Bestückung**

Choose your Roller Cabinet with Sets
or only the sets



Legende S. H 36

Art.-Nr./Art.-No.	Produkt/Product
5995-023	Bestückung 179-tlg./ Sets with 179 pcs.
6911-123	Werk. »PROFISuperior«, 7 Schubf. mit Bestückung/with Sets
7901-523	Werkstattw. »SpaceLine«, 7 Schubf. mit Bestückung/with Sets
5901-123	Werkstattw. »RedLine«, 7 Schubf. mit Bestückung/with Sets
5901-523	Werkstattw. »SuperBlue«, 7 Schubf. mit Bestückung/with Sets
5901-223	Werkstattw. »BlackLine«, 7 Schubf. mit Bestückung/with Sets
4901-523	Werkstattw. »ECOBlue«, 6 Schubf. mit Bestückung/with Sets

6911-123

**Werkstattwagen »PROFISuperior«
mit 7 Schubfächern, bestückt**
Roller Cabinet »PROFISuperior«,
7 Drawers with Sets

7901-523

**Werkstattwagen »SpaceLine«
mit 7 Schubfächern, bestückt**
Roller Cabinet »SpaceLine«, 7 Drawers with Sets

5901-123

Werkstattwagen »RedLine« mit 7 Schubfächern, best.
Roller Cabinet »RedLine«, 7 Drawers with Sets

5901-523

Werkst. »SuperBlue« mit 7 Schubfächern, bestückt
Roller Cabinet »SuperBlue«, 7 Drawers with Sets

5901-223

Werkstattwagen »BlackLine« mit 7 Schubfächern, bestückt
Roller Cabinet »BlackLine«, 7 Drawers with Sets

4901-523

Werkstattwagen »ECOBlue« mit 6 Schubfächern, bestückt
Roller Cabinet »ECOBlue«, 6 Drawers with Sets



5995-023

Bestehend aus / Composed of

**5999-111 + 5999-131 + 5999-191 + 5999-011 + 5999-321 + 5999-021 +
5999-065 + 5999-062 + 5999-101 + 5999-082 + 5999-171 + 5999-331**

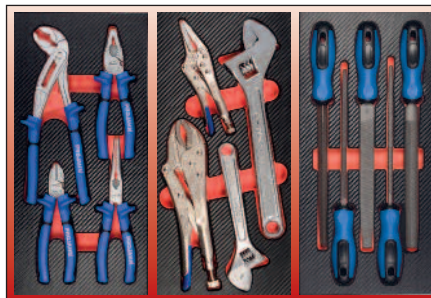
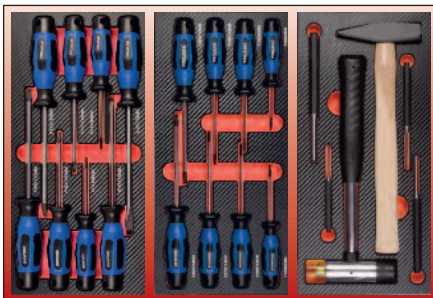
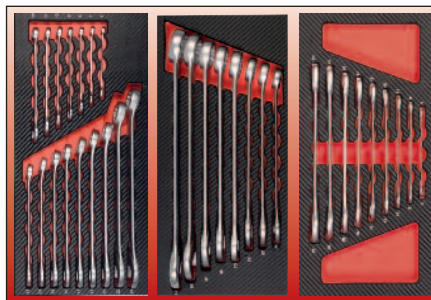
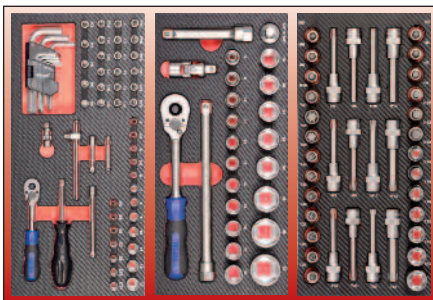

Werkstattwagen-Bestückung für 4 Schubfächern, 198-teilig

Roller Cabinet Sets for 4 Drawers, 198 pieces

189
tlg./pcs.

Art-Gruppe 171/172
Article Group 171/172

**Wählen Sie Ihren
Werkstattwagen mit Bestückung
oder nur die Bestückung**
Choose your Roller Cabinet with Sets
or only the sets



Art.-Nr./Art.-No.	Produkt/product
5995-022	Bestückung 198-tlg./ Sets with 198 pcs.
6911-122	Werk. »PROFISuperior«, 7 Schubf. mit Bestückung/with Sets
7901-522	Werkstattw. »SpaceLine«, 7 Schubf. mit Bestückung/with Sets
5901-122	Werkstattw. »RedLine«, 7 Schubf. mit Bestückung/with Sets
5901-522	Werkstattw. »SuperBlue«, 7 Schubf. mit Bestückung/with Sets
5901-222	Werkstattw. »BlackLine«, 7 Schubf. mit Bestückung/with Sets
4901-522	Werkstattw. »ECOBlue«, 6 Schubf. mit Bestückung/with Sets

6911-122

**Werkstattwagen »PROFISuperior«
mit 7 Schubfächern, bestückt**
Roller Cabinet »PROFISuperior«,
7 Drawers with Sets

7901-522

**Werkstattwagen »SpaceLine«
mit 7 Schubfächern, bestückt**
Roller Cabinet »SpaceLine«, 7 Drawers with Sets

5901-122

Werkstattwagen »RedLine« mit 7 Schubfächern, best.
Roller Cabinet »RedLine«, 7 Drawers with Sets

5901-522

Werkst. »SuperBlue« mit 7 Schubfächern, bestückt
Roller Cabinet »SuperBlue«, 7 Drawers with Sets

5901-222

Werkstattwagen »BlackLine« mit 7 Schubfächern, bestückt
Roller Cabinet »BlackLine«, 7 Drawers with Sets

4901-522

Werkstattwagen »ECOBlue« mit 6 Schubfächern, bestückt
Roller Cabinet »ECOBlue«, 6 Drawers with Sets



5995-022

Bestehend aus / Composed of

**5999-111 + 5999-131 + 5999-191 + 5999-011 + 5999-321 + 5999-021 +
5999-065 + 5999-082 + 5999-101 + 5999-181 (Dreifacheinlage/Triple Set)**

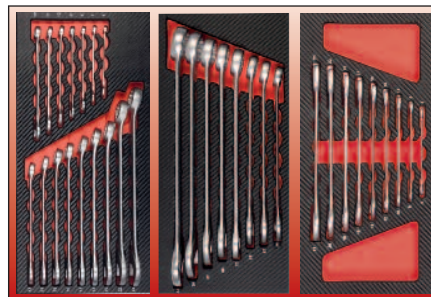
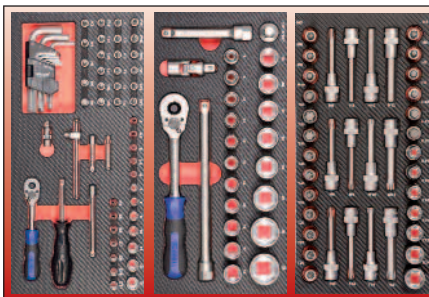

Werkstattwagen-Bestückung für 4 Schubfächern, 210-teilig

Roller Cabinet Sets for 4 Drawers, 210 pieces

210
tlg./pcs.

Art.-Gruppe 171/172
Article Group 171/172

**Wählen Sie Ihren
Werkstattwagen mit Bestückung
oder nur die Bestückung**
Choose your Roller Cabinet with Sets
or only the sets

 Legende S. H 36

Art.-Nr./Art.-No.	Produkt/Product
5995-021	Bestückung 201-tlg./ Sets with 201 pcs.
6911-121	Werk. »PROFISuperior«, 7 Schubf. mit Bestückung/with Sets
7901-521	Werkstattw. »SpaceLine«, 7 Schubf. mit Bestückung/with Sets
5901-121	Werkstattw. »RedLine«, 7 Schubf. mit Bestückung/with Sets
5901-521	Werkstattw. »SuperBlue«, 7 Schubf. mit Bestückung/with Sets
5901-221	Werkstattw. »BlackLine«, 7 Schubf. mit Bestückung/with Sets
4901-521	Werkstattw. »ECOBlue«, 6 Schubf. mit Bestückung/with Sets

6911-121

**Werkstattwagen »PROFISuperior«
mit 7 Schubfächern, bestückt**
Roller Cabinet »PROFISuperior«,
7 Drawers with Sets

7901-521

**Werkstattwagen »SpaceLine«
mit 7 Schubfächern, bestückt**
Roller Cabinet »SpaceLine«, 7 Drawers with Sets

5901-121

Werkstattwagen »RedLine« mit 7 Schubfächern, best.
Roller Cabinet »RedLine«, 7 Drawers with Sets

5901-521

Werkst. »SuperBlue« mit 7 Schubfächern, bestückt
Roller Cabinet »SuperBlue«, 7 Drawers with Sets

5901-221

Werkstattwagen »BlackLine« mit 7 Schubfächern, bestückt
Roller Cabinet »BlackLine«, 7 Drawers with Sets

4901-521

Werkstattwagen »ECOBlue« mit 6 Schubfächern, bestückt
Roller Cabinet »ECOBlue«, 6 Drawers with Sets



5995-021

Bestehend aus / Composed of

**5999-111 + 5999-131 + 5999-101 + 5999-011 + 5999-321 + 5999-021 + 5999-065 +
5999-062 + 5999-082 + 5999-331 + 5999-361 (Doppeleinlage/Double Set)**

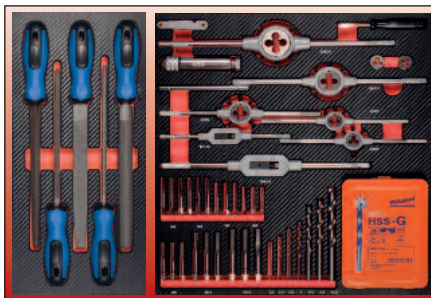
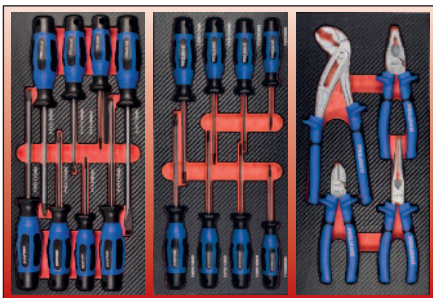
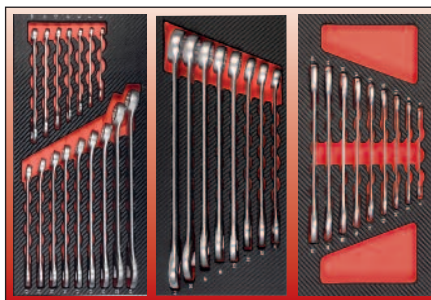
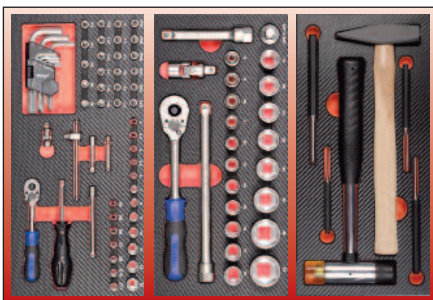

Werkstattwagen-Bestückung für 5 Schubfächern, 320-teilig

Roller Cabinet Sets for 5 Drawers, 320 pieces

320
tlg./pcs.

Art.-Gruppe 171/172
Article Group 171/172

**Wählen Sie Ihren
Werkstattwagen mit Bestückung
oder nur die Bestückung**
Choose your Roller Cabinet with Sets
or only the sets



Art.-Nr./Art.-No.	Produkt/Product
5995-141	Bestückung 320-tlg./ Sets with 320 pcs.
6911-141	Werk. »PROFISuperior«, 7 Schubf. mit Bestückung/with Sets
7901-541	Werkstattw. »SpaceLine«, 7 Schubf. mit Bestückung/with Sets
5901-141	Werkstattw. »RedLine«, 7 Schubf. mit Bestückung/with Sets
5901-541	Werkstattw. »SuperBlue«, 7 Schubf. mit Bestückung/with Sets
5901-241	Werkstattw. »BlackLine«, 7 Schubf. mit Bestückung/with Sets
4901-541	Werkstattw. »ECOBlue«, 6 Schubf. mit Bestückung/with Sets

6911-141

**Werkstattwagen »PROFISuperior«
mit 7 Schubfächern, bestückt**
Roller Cabinet »PROFISuperior«,
7 Drawers with Sets

7901-541

**Werkstattwagen »SpaceLine«
mit 7 Schubfächern, bestückt**
Roller Cabinet »SpaceLine«, 7 Drawers with Sets

5901-141

Werkstattwagen »RedLine« mit 7 Schubfächern, best.
Roller Cabinet »RedLine«, 7 Drawers with Sets

5901-541

Werkst. »SuperBlue« mit 7 Schubfächern, bestückt
Roller Cabinet »SuperBlue«, 7 Drawers with Sets

5901-241

Werkstattwagen »BlackLine« mit 7 Schubfächern, bestückt
Roller Cabinet »BlackLine«, 7 Drawers with Sets

4901-541

Werkstattwagen »ECOBlue« mit 6 Schubfächern, bestückt
Roller Cabinet »ECOBlue«, 6 Drawers with Sets



5995-141

Bestehend aus / Composed of

5999-111 + 5999-131 + 5999-191 + 5999-321 + 5999-011 + 5999-021 + 5999-065 + 5999-062 + 5999-341 + 5999-171 + 5999-082 + 5999-101 + 5999-331 + 5999-393 + 3789

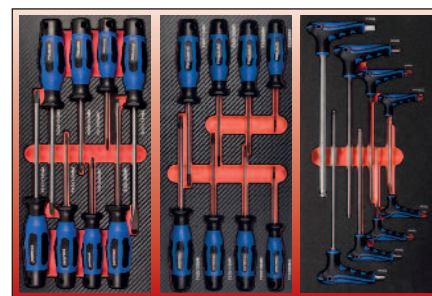
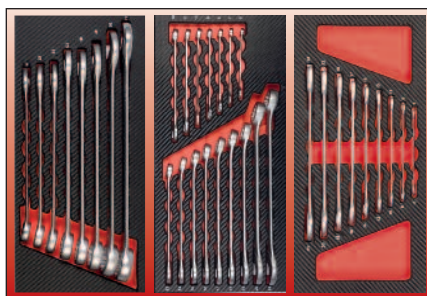
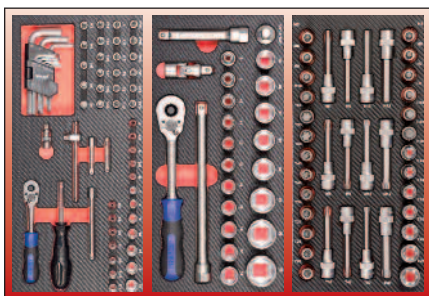

PROForm Werkstattwagen Einlagen

PROForm Inlays for Roller Cabinets

Art.-Gruppe 171
Article Group 171

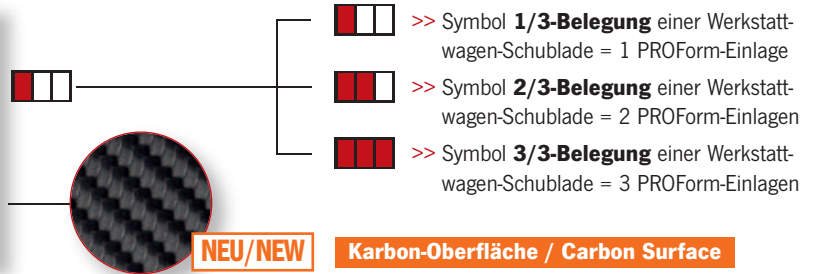

Die PROJAHN PROForm-Einlagen (2-Farben-Kontrast-System) sind passgenau auf alle PROJAHN Werkstattwagen und das PROForm-Box-Koffersystem abgestimmt. Diese PROForm-Einlagen gibt es als Einfach-Einlage (395 x 186 x 35mm), als Doppel-Einlage (395 x 378 x 35mm) oder als Dreifach-Einlage (395 x 568 x 35mm), wobei die Dreifach-Einlage einer kompletten Schublade entspricht. Die PROForm-Einlagen sind aus hochwertigem, bruch- und formstabilem Polymer-Kunststoff gefertigt und bieten Ihren Werkzeugen optimalen Halt und Schutz.

PROJAHN PROForm-Inlays (2-colour-system) are accurate'n produced for all PROJAHN Roller Cabinets and PROForm-Box Cases. These PROForm-Inlays are available as 1/3-inlay (395 x 186 x 35mm), as 2/3-inlay (395 x 378 x 35mm) or as 3/3-inlay (395 x 568 x 35mm). The 3/3-inlay fills a complete drawer. The PROForm-Inlays are produced by special, hard-to-brake, rubber foam and secure your tools.

5999-011 **PROFESSIONAL** PLUS STANDARD

PROForm Einlagesystem Ringgabelschlüssel, 16-teilig

PROForm Combination Wrench Inlay, 16 pieces

Inhalt/Contents:

6 - 7 - 8 - 9 - 10 - 11 - 12 - 13 - 14 - 15 - 16 - 17 - 18 - 19 - 22 - 24 mm

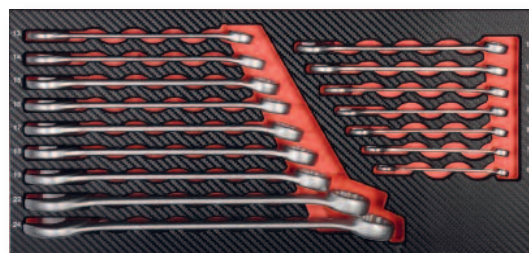

16
tlg./pcs.

395 x 186 x 35 mm

Art.-Nr./Art.-No.	tlg./pcs.	L./L.	B./W.	H./H.	€
5999-011	16				
5999-01E		395	186	35	Einlage leer/empty inlay

5999-321 **PROFESSIONAL** PLUS STANDARD

PROForm Einlagesystem Ringgabelschlüssel, 8-teilig

PROForm Combination Wrench Inlay, 8 pieces

Inhalt/Contents:

20 - 21 - 23 - 25 - 26 - 27 - 30 - 32 mm



8
tlg./pcs.

395 x 186 x 35 mm

Art.-Nr./Art.-No.	tlg./pcs.	L./L.	B./W.	H./H.	€
5999-321	8				
5999-32E		395	186	35	Einlage leer/empty inlay

PROForm Werkstattwagen Einlagen

PROForm Inlays for Roller Cabinets

Art.-Gruppe 171
Article Group 171

5999-411 **PROFESSIONAL** PLUS STANDARD

PROForm Einlegesystem Ringgabelschlüssel Zoll, 12-teilig

PROForm Combination Wrench Inlay Inch, 12 pieces

Inhalt/Contents:

1/4" - 5/16" - 3/8" - 7/16" - 1/2" - 9/16" - 5/8" -
11/16" - 3/4" - 7/8" - 15/16" - 1"



12
tlg./pcs.



395 x 186 x 35 mm

Art.-Nr./Art.-No.	tlg./pcs.	L./L.	B./W.	H./H.	€
5999-411	12				
5999-41E		395	186	35	Einlage leer/empty inlay

5999-021 **PROFESSIONAL** PLUS STANDARD

PROForm Einlegesystem Doppelgabelschlüssel, 9-teilig

PROForm Double Open End Wrench Inlay, 9 pieces

Inhalt/Contents:

6 x 7 - 8 x 9 - 10 x 11 - 12 x 13 - 14 x 15 - 16 x 17 - 18 x 19 - 20 x 22 -
21 x 23 mm



9
tlg./pcs.



395 x 186 x 35 mm

Art.-Nr./Art.-No.	tlg./pcs.	L./L.	B./W.	H./H.	€
5999-021	9				
5999-02E		395	186	35	Einlage leer/empty inlay

5999-031 **PROFESSIONAL** PLUS STANDARD

PROForm Einlegesystem Doppelringschlüssel, 8-teilig

PROForm Double Ring Wrench Inlay, 8 pieces

Inhalt/Contents:

6 x 7 - 8 x 9 - 10 x 11 - 12 x 13 - 14 x 15 - 16 x 17 - 18 x 19 - 20 x 22 mm



8
tlg./pcs.



395 x 186 x 35 mm

Art.-Nr./Art.-No.	tlg./pcs.	L./L.	B./W.	H./H.	€
5999-031	8				
5999-03E		395	186	35	Einlage leer/empty inlay

PROForm Werkstattwagen Einlagen

PROForm Inlays for Roller Cabinets

Art.-Gruppe 171
Article Group 171

5999-041

PROFESSIONAL PLUS STANDARD

PROForm Einlagesystem GearTech Ratschenschlüssel „umschaltbar“, 12-teilig

PROForm Reversible GearTech Ratcheting Wrench Inlay, 12 pieces

Inhalt/Contents:

8 - 9 - 10 - 11 - 12 - 13 - 14 - 15 - 16 - 17 - 18 - 19 mm



12
tlg./pcs.



395 x 186 x 35 mm

Art.-Nr./Art.-No.	tlg./pcs.	L./L.	B./W.	H./H.	€
5999-041	12				
5999-04E		395	186	35	Einlage leer/empty inlay

5999-051

PROFESSIONAL PLUS STANDARD

PROForm Einlagesystem GearTech Ratschenschlüssel „klassik“ ohne Umschaltknopf, 12-teilig

PROForm GearTech „classic“ Inlay, 12 pieces

Inhalt/Contents:

8 - 9 - 10 - 11 - 12 - 13 - 14 - 15 - 16 - 17 - 18 - 19 mm

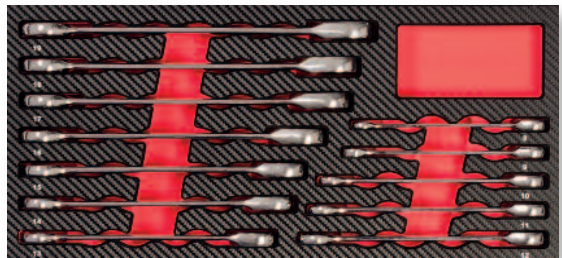

12
tlg./pcs.



395 x 186 x 35 mm

Art.-Nr./Art.-No.	tlg./pcs.	L./L.	B./W.	H./H.	€
5999-051	12				
5999-05E		395	186	35	Einlage leer/empty inlay

5999-052

PROFESSIONAL PLUS STANDARD

PROForm Einlagesystem GearTech Ratschenschlüssel „flexibel“ ohne Umschaltknopf, 12-teilig

PROForm GearTech „flexible“ Inlay, 12 pieces

Inhalt/Contents:

8 - 9 - 10 - 11 - 12 - 13 - 14 - 15 - 16 - 17 - 18 - 19 mm

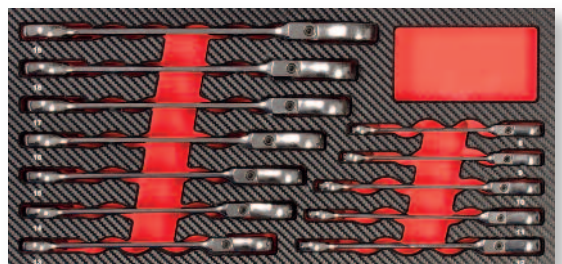

12
tlg./pcs.



395 x 186 x 35 mm

Art.-Nr./Art.-No.	tlg./pcs.	L./L.	B./W.	H./H.	€
5999-052	12				
5999-05E		395	186	35	Einlage leer/empty inlay

PROForm Werkstattwagen Einlagen

PROForm Inlays for Roller Cabinets

Art.-Gruppe 171
Article Group 171

5999-111

PROFESSIONAL PLUS STANDARD

NEU/NEW

PROForm Einlegesystem

1/4" Steckschlüssel Satz, 58-teilig

PROForm 1/4" Socket Inlay, 58 pieces

Inhalt/Contents:

Knarre, Steckgriff, Gleitgriff, Inbusschlüssel-Satz 9-teilig,

Verlängerungen 50 + 100 mm, Stecknuss Bit Adapter 50 mm,

Kardangeln, Innen TX Nüsse E4 - 5 - 6 - 7 - 8 - 10 - 11,

6-kant Nüsse 4 - 4,5 - 5 - 5,5 - 6 - 7 - 8 - 9 - 10 - 11 - 12 - 13 mm,

Bit Nüsse: PH1 - 2 - 3, PZ1 - 2 - 3, Schlitz 4 - 5,5 - 6,5 mm, TX8 - 9 - 10 - 15 - 20 - 25 - 27 - 30 - 40, Inbus 3 - 4 - 5 - 6 - 8 mm

Ratchet, Spinner Handle, Sliding T-Handle, Hex Key Set 9 pieces, Extension Bars 50 + 100 mm, Socket Adapter 50 mm, Universal Joint,

TX Sockets E4 - 5 - 6 - 7 - 8 - 10 - 11, Sockets 4 - 4,5 - 5 - 5,5 - 6 - 7 - 8 - 9 - 10 - 11 - 12 - 13 mm,

Bit Sockets: PH1 - 2 - 3, PZ1 - 2 - 3, Slotted 4 - 5,5 - 6,5 mm, TX8 - 9 - 10 - 15 - 20 - 25 - 27 - 30 - 40, Hex 3 - 4 - 5 - 6 - 8 mm

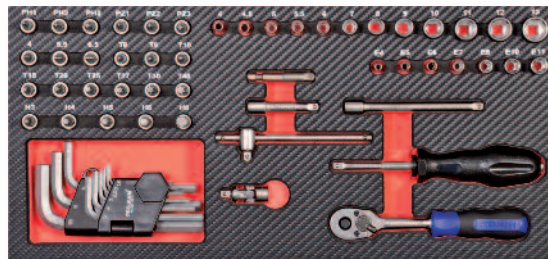

395 x 186 x 35 mm

58
tlg./pcs.

1/4"



Art.-Nr./Art.-No.	tlg./pcs.	L./L.	B./W.	H./H.	€
5999-111	58				
5999-11E		395	186	35	Einlage leer/empty inlay

5999-121

PROFESSIONAL PLUS STANDARD

NEU/NEW

PROForm Einlegesystem 3/8" Steckschlüssel Satz, 23-teilig

PROForm 3/8" Socket Inlay, 23 pieces

Inhalt/Contents:

Knarre, T-Gleitadapter, Verlängerungen 75 + 250 mm,

Kardangeln, 6-kant Nüsse 6 - 7 - 8 - 9 - 10 - 11 - 12 - 13 - 14 -

15 - 16 - 17 - 18 - 19 - 22 - 24 mm,

Adapter von 3/8" (Knarre) auf 1/4" (Nuss),

Adapter von 3/8" (Knarre) auf 1/2" (Nuss), Adapter von 1/2" (Knarre) auf 3/8" (Nuss)

Ratchet, T-Adapter, Extension Bars 75 + 250 mm, Universal Joint, Sockets 6 - 7 - 8 - 9 - 10 - 11 - 12 - 13 - 14 - 15 - 16 - 17 - 18 - 19 - 22 - 24 mm,

Adapter 3/8" (Ratchet) x 1/4" (Socket), Adapter 3/8" (Ratchet) x 1/2" (Socket), Adapter 1/2" (Ratchet) x 3/8" (Socket)

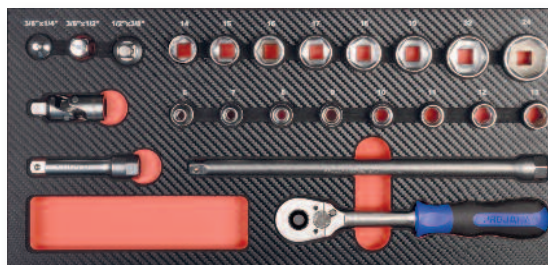

395 x 186 x 35 mm

23
tlg./pcs.

3/8"



Art.-Nr./Art.-No.	tlg./pcs.	L./L.	B./W.	H./H.	€
5999-121	23				
5999-12E		395	186	35	Einlage leer/empty inlay

5999-131

PROFESSIONAL PLUS STANDARD

NEU/NEW

PROForm Einlegesystem 1/2" Steckschlüssel Satz, 24-teilig

PROForm 1/2" Socket Inlay, 24 pieces

Inhalt/Contents:

Knarre, T-Gleitadapter, Verlängerungen 125 + 250 mm,

Kardangeln, 6-kant Nüsse 8 - 9 - 10 - 11 - 12 - 13 - 14 - 15 -

16 - 17 - 18 - 19 - 20 - 21 - 22 - 24 - 27 - 30 - 32 mm

Ratchet, T-Adapter, Extension Bars 125 + 250 mm, Universal Joint,

Sockets 8 - 9 - 10 - 11 - 12 - 13 - 14 - 15 - 16 - 17 - 18 - 19 - 20 - 21 - 22 - 24 - 27 - 30 - 32 mm

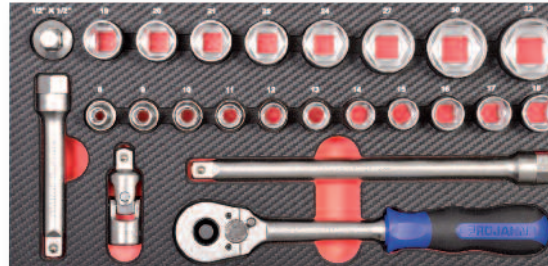

395 x 186 x 35 mm

24
tlg./pcs.

1/2"



Art.-Nr./Art.-No.	tlg./pcs.	L./L.	B./W.	H./H.	€
5999-131	24				
5999-13E		395	186	35	Einlage leer/empty inlay

PROForm Werkstattwagen Einlagen

PROForm Inlays for Roller Cabinets

MULTISTECKNUSS
Xi-on

Art.-Gruppe 171
Article Group 171

5999-511 **Xi-on**

PROFESSIONAL PLUS STANDARD

PROForm Einlagesystem 1/4" Xi-on Steckschl. Satz, 18-teilig

PROForm 1/4" Xi-on Socket Inlay, 18 pieces

Inhalt/Contents:

Knarre, 72-Zahn, Steckgriff, Gleitgriff, Verlängerung 50 mm, Kardangeln, Austreiber, Xi-on Stecknüsse 4 - 4,5 - 5 - 5,5 - 6 - 7 - 8 - 9 - 10 - 11 - 12 - 13 mm

Ratchet, 72-Teeth, Spinner Handle, Extension Bars 125 + 250 mm,

Universal Joint, Extractor, Xi-on Sockets 4 - 4,5 - 5 - 5,5 - 6 - 7 - 8 - 9 - 10 - 11 - 12 - 13 mm

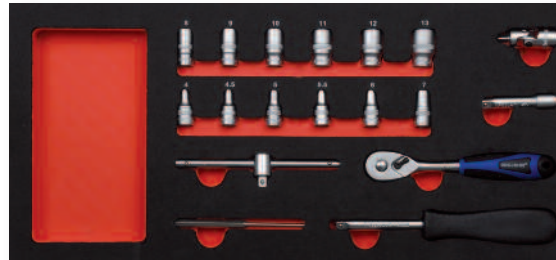

395 x 186 x 35 mm

18
tlg./pcs.

1/4"



Art.-Nr./Art.-No.	tlg./pcs.	L./L.	B./W.	H./H.	€
5999-511	18				
5999-51E		395	186	35	Einlage leer/empty inlay

5999-521 **Xi-on**

PROFESSIONAL PLUS STANDARD

PROForm Einlagesystem 3/8" Xi-on Steckschl. Satz, 17-teilig

PROForm 1/2" Xi-on Socket Inlay, 17 pieces

Inhalt/Contents:

Knarre, 72-Zahn, Gleitgriff, Verlängerungen 75 + 150 mm, Kardangeln, Austreiber, Xi-on Stecknüsse 8 - 10 - 11 - 12 - 13 - 14 - 15 - 16 - 17 - 18 - 19 mm

Ratchet, 72-Teeth, Sliding T-Handle, Extension Bars 75 + 150mm,

Universal Joint, Extractor, Xi-on Sockets

8 - 10 - 11 - 12 - 13 - 14 - 15 - 16 - 17 - 18 - 19 mm

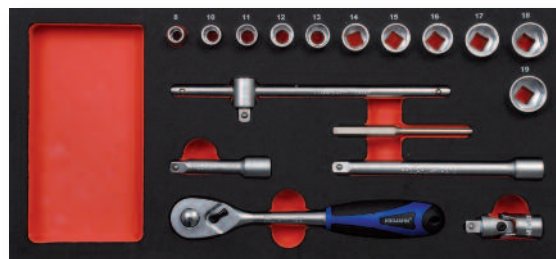

395 x 186 x 35 mm

17
tlg./pcs.

3/8"



Art.-Nr./Art.-No.	tlg./pcs.	L./L.	B./W.	H./H.	€
5999-521	17				
5999-52E		395	186	35	Einlage leer/empty inlay

5999-531 **Xi-on**

PROFESSIONAL PLUS STANDARD

PROForm Einlagesystem

1/2" Xi-on Steckschl. Satz, 23-teilig

PROForm 1/2" Xi-on Socket Inlay, 23 pieces

Inhalt/Contents:

Knarre, 60-Zahn, Gleitgriffadapter, Verlängerungen 125 - 250 mm, Kardangeln, Austreiber, Xi-on Stecknüsse 10 - 11 - 12 - 13 - 14 - 15 - 16 - 17 - 18 - 19 - 22 - 24 - 27 - 30 - 32 mm, Zündkerzen-Stecknüsse 16 + 21 mm

Ratchet, 60-Teeth, Sliding T-Handle Adapter, Extension Bars 125 + 250 mm,

Universal Joint, Extractor, Xi-on Sockets 10 - 11 - 12 - 13 - 14 - 15 - 16 -

17 - 18 - 19 - 22 - 24 - 27 - 30 - 32 mm, Spark Plug Sockets 16 + 21 mm



395 x 186 x 35 mm

23
tlg./pcs.

1/2"



Art.-Nr./Art.-No.	tlg./pcs.	L./L.	B./W.	H./H.	€
5999-531	23				
5999-53E		395	186	35	Einlage leer/empty inlay

PROForm Werkstattwagen Einlagen

PROForm Inlays for Roller Cabinets

Art.-Gruppe 171
Article Group 171

5999-551

PROFESSIONAL PLUS STANDARD

NEU/NEW

PROForm Einlegesystem GearTech Durchschraubknarre, 17-teilig
PROForm Go-Through-Socket Inlay, 17 pieces

Inhalt/Contents:

Durchgangsnüsse 10 - 11 - 12 - 13 - 14 - 15 - 16 - 17 - 18 - 19 - 21 - 22 - 24 mm, Verlängerung 80 mm, 1/4" Adapter, 3/8" Adapter, 3D-GearTech-FLEX-Durchschraub-Knarre

Go-Through-Sockets 10 - 11 - 12 - 13 - 14 - 16 - 17 - 18 - 19 - 21 - 22 - 24 mm, Extension 80 mm, 1/4" Adapter, 3/8" Adapter, 3D-GearTech-FLEX-Ratchet



17
tlg./pcs.

395 x 186 x 35 mm

Art.-Nr./Art.-No.	tlg./pcs.	L./L.	B./W.	H./H.	€
5999-551	17				
5999-55E		395	186	35	Einlage leer/empty inlay

5999-421

PROFESSIONAL PLUS STANDARD

PROForm Einlegesystem Stecknuss, Zoll, 51-teilig (Doppeleinlage)
PROForm Socket Inlay, Inch, 51 pieces (2/3 Inlay)

Inhalt/Contents:

1/4" + 1/2" Knarre, Stecknüsse 3/16" - 1 1/4", Tiefe Stecknüsse 3/16" - 15/16", Gleitgriff-Adapter, Zündkerzen-Stecknüsse 5/16" + 13/16", Kardangelenke, Verlängerungen 2" - 3" - 5" - 10", Steckgriff

1/4" + 1/2" Ratchet, Sockets 3/16" - 1 1/4", Deep Sockets 3/16" - 15/16", Sliding T-Adapter, Spark Plug Sockets 5/16" + 13/16", Universal Joint, Extension Bars 2" - 3" - 5" - 10", Spinner Handle

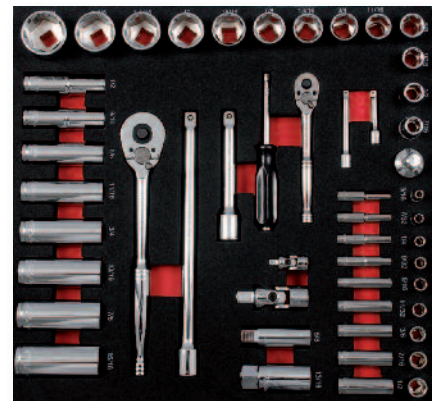

51
tlg./pcs.

395 x 375 x 35 mm

Art.-Nr./Art.-No.	tlg./pcs.	L./L.	B./W.	H./H.	€
5999-421	51				
5999-42E		395	375	35	Einlage leer/empty inlay

5999-441

PROFESSIONAL PLUS STANDARD

PROForm Einlegesystem Werkzeugsatz 3/4", 21-teilig (Dreifacheinlage, Höhe 90 mm)
PROForm Socket Inlay 3/4", 21 pieces (3/3 Inlay, High 90 mm)

Inhalt/Contents:

Knarre Verlängerungen 100 - 200 - 400 mm, Gleitgriff, Stecknüsse 19 - 21 - 22 - 23 - 24 - 26 - 27 - 29 - 30 - 32 - 35 - 36 - 38 - 41 - 46 - 50 mm

Ratchet Handle, Extension Bars 100 - 200 - 400 mm, Sliding T-Bar, Sockets 19 - 21 - 22 - 23 - 24 - 26 - 27 - 29 - 30 - 32 - 35 - 36 - 38 - 41 - 46 - 50 mm



21
tlg./pcs.

395 x 560 x 35 mm

Art.-Nr./Art.-No.	tlg./pcs.	L./L.	B./W.	H./H.	€
5999-441	21				
5999-44E		395	560	35	Einlage leer/empty inlay

PROForm Werkstattwagen Einlagen

PROForm Inlays for Roller Cabinets

Art.-Gruppe 171
Article Group 171

5999-431 PROFESSIONAL PLUS STANDARD

PROForm Einlagesystem 1/2" lange Stecknuss, 12-teilig

PROForm 1/2" Deep Impact Socket Inlay, 12 pieces

Inhalt/Contents:

10 - 11 - 12 - 13 - 14 - 15 - 16 - 17 - 18 - 19 - 21 - 22 mm
16 + 21 mm = Zündkerzenstecknüsse / Spark Plug Sockets

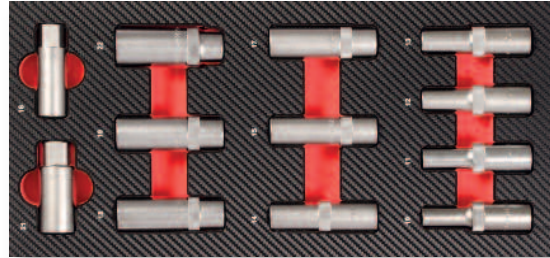

12
tlg./pcs.

1/2"



395 x 186 x 35 mm

Art.-Nr./Art.-No.	tlg./pcs.	L./L.	B./W.	H./H.	€
5999-431	12				
5999-43E		395	186	35	Einlage leer/empty inlay

5999-191 PROFESSIONAL PLUS STANDARD

PROForm Einlagesystem 1/2" KFZ Spezial-Einlage, 38-teilig

PROForm 1/2" Special Car Repairing Inlay, 38 pieces

Inhalt/Contents:

Inbus-Bit-Nuss 60 mm lang 5 - 6 - 7 - 8 - 10 - 12 mm,
Inbus-Bit-Nuss 100 mm lang 6 - 8 - 10 - 12 mm,
TX-Bit-Nuss 60 mm lang,
TX20 - 25 - 27 - 30 - 40 - 45 - 50 - 55 - 60,
TX-Bit-Nuss 100 mm lang TX30 - 40 - 50 - 60, Vielzahn-Bit-Nuss 60 mm lang M5 - 6 - 8 - 10,
Vielzahn-Bit-Nuss 100 mm lang M6 - 8 - 10 - 12, Innen-TX-Nuss E12 - 14 - 16 - 18 - 20 - 22 - 24

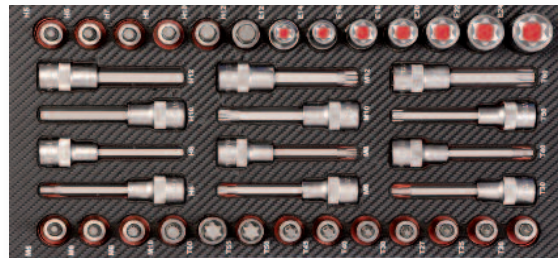

38
tlg./pcs.

1/2"



395 x 186 x 35 mm

Hex Bit Sockets (60 mm) 5 - 6 - 7 - 8 - 10 - 12 mm, Hex Bit Sockets (100 mm) 6 - 8 - 10 - 12mm,
TX Bit Sockets (60 mm) T20 - 25 - 27 - 30 - 40 - 45 - 50 - 55 - 60, TX Bit Sockets (100 mm) T30 - 40 - 50 - 60,
Spline Bit Sockets (60 mm) M5 - 6 - 8 - 10, Spline Bit Sockets (100 mm) M6 - 8 - 10 - 12, TX Sockets E12 - 14 - 16 - 18 - 20 - 22 - 24

Art.-Nr./Art.-No.	tlg./pcs.	L./L.	B./W.	H./H.	€
5999-191	38				
5999-19E		395	186	35	Einlage leer/empty inlay

PROForm Werkstattwagen Einlagen

PROForm Inlays for Roller Cabinets

Art-Gruppe 171
Article Group 171

5999-151

PROFESSIONAL PLUS STANDARD

PROForm Einlegesystem 1/2" Schlagnuss, 30-teilig

PROForm 1/2" Impact Socket Inlay, 30 pieces

Inhalt/Contents:

Nuss 8 - 9 - 10 - 11 - 12 - 13 - 14 - 15 - 16 - 17 - 18 - 19 - 21 - 22 - 24 mm, tiefe Nuss 17 - 19 - 21 - 22 - 24 mm, tiefe Nuss für Alufelgen 17 - 19 - 21 mm, Kardangelenk, Verlängerung 125 mm, Adapter 3/4" (Maschine) auf 1/2" (Nuss), 2x Sicherungsring, 2x Sicherungsstift



30
tlg./pcs.

1/2"



395 x 186 x 35 mm

Sockets 8 - 9 - 10 - 11 - 12 - 13 - 14 - 15 - 16 - 17 - 18 - 19 - 21 - 22 - 24 mm, Deep Sockets 17 - 19 - 21 - 22 - 24 mm, Deep Thin Wall Sockets 17 - 19 - 21 mm, Universal Joint, Extension Bar 125 mm, Adapter 3/4" (Machine) x 1/2" (Socket), 2 pieces Ring for Impact Sockets, 2 pieces Pin for Impact Sockets

Art.-Nr./Art.-No.	tlg./pcs.	L./L.	B./W.	H./H.	€
5999-151	30				
5999-15E		395	186	35	Einlage leer/empty inlay

5999-371

PROFESSIONAL PLUS STANDARD

PROForm Einlegesystem 1/2" Schlagnuss, 28-teilig

PROForm 1/2" Impact Socket Inlay, 28 pieces

Inhalt/Contents:

TX-Nuss TX20 - 25 - 27 - 30 - 40 - 45 - 50 - 55 - 60 - 70, Inbus-Nuss 4 - 5 - 6 - 8 - 10 - 12 - 14 - 17 - 19 mm, Innen-TX-Nuss E10 - 11 - 12 - 14 - 16 - 18 - 20 - 22 - 24



28
tlg./pcs.

1/2"



395 x 186 x 35 mm

TX-Sockets TX20 - 25 - 27 - 30 - 40 - 45 - 50 - 55 - 60 - 70, Hex-Sockets 4 - 5 - 6 - 8 - 10 - 12 - 14 - 17 - 19 mm, TX-Sockets E10 - 11 - 12 - 14 - 16 - 18 - 20 - 22 - 24

Art.-Nr./Art.-No.	tlg./pcs.	L./L.	B./W.	H./H.	€
5999-371	28				
5999-37E		395	186	35	Einlage leer/empty inlay

5999-141*

PROFESSIONAL PLUS STANDARD

PROForm Einlegesystem Pfeifenkopfschlüssel mit Bohrung, 12-teilig

PROForm Through-Hole Open-Socket Wrench Inlay, 12 pieces

Inhalt/Contents:

8 - 9 - 10 - 11 - 12 - 13 - 14 - 15 - 16 - 17 - 18 - 19 mm

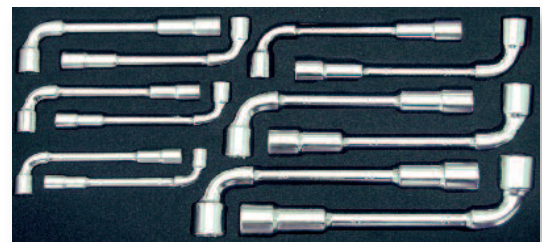

12
tlg./pcs.



395 x 186 x 35 mm

Art.-Nr./Art.-No.	tlg./pcs.	L./L.	B./W.	H./H.	€
5999-141*	12				
5999-14E*		395	186	35	Einlage leer/empty inlay

*Nur solange Vorrat reicht / only stock out selling quantities

PROForm Werkstattwagen Einlagen

PROForm Inlays for Roller Cabinets

Art.-Gruppe 171
Article Group 171

5999-065 **PROFESSIONAL** PLUS STANDARD

PROForm Einlagesystem

Phillips-, Pozidriv- und Schlitz-Schraubendreher, 8-teilig

PROForm Phillips-, Pozidriv- and Slotted Screwdriver Inlay, 8 pieces

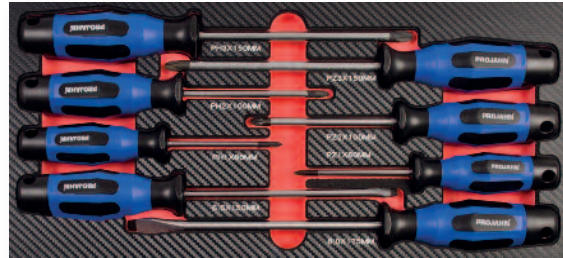

8
tlg./pcs.



395 x 186 x 35 mm



Art.-Nr./Art.-No.	tlg./pcs.	Inhalt/pcs.	L./L.	B./W.	H./H.	€
5999-065	8	PH 1 - 2 - 3 PZ 1 - 2 - 3	Schlitz 1,2 x 6,5 - 1,2 x 8,0		gemischt/mixed	
5999-065E			395	186	35	Einlage leer/empty inlay

5999-064 **PROFESSIONAL** PLUS STANDARD

PROForm Einlagesystem

Phillips- und Schlitz-Schraubendreher, 7-teilig

PROForm Phillips and Slotted Screwdriver Inlay, 7 pieces



7
tlg./pcs.



395 x 186 x 35 mm



Art.-Nr./Art.-No.	tlg./pcs.	Inhalt/pcs.	L./L.	B./W.	H./H.	€
5999-064	7	PH 1 - 2 - 3 Schlitz 0,8 x 4,0 - 1,0 x 5,5 - 1,2 x 6,5 - 1,2 x 8,0			gemischt/mixed	
5999-064E			395	186	35	Einlage leer/empty inlay

5999-062 **PROFESSIONAL** PLUS STANDARD

PROForm Einlagesystem

Innen-TORX-Schraubendreher, 8-teilig

PROForm TX Screwdriver Inlay, 8 pieces

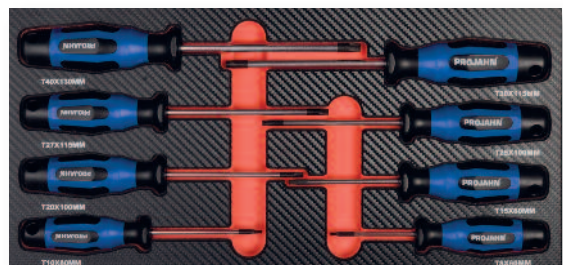

8
tlg./pcs.



395 x 186 x 35 mm



Art.-Nr./Art.-No.	tlg./pcs.	Inhalt/pcs.	L./L.	B./W.	H./H.	€
5999-062	8	T8 - T10 - T15 - T20 - T25 - T27 - T30 - T40	TX			
5999-062E			395	186	35	Einlage leer/empty inlay

PROForm Werkstattwagen Einlagen

PROForm Inlays for Roller Cabinets

Art.-Gruppe 171
Article Group 171

5999-481 **PROFESSIONAL** PLUS STANDARD

PROForm Einlegesystem Schraubendreher, 10-teilig (Doppeleinlage)

PROForm Screwdriver Inlay, 10 pieces

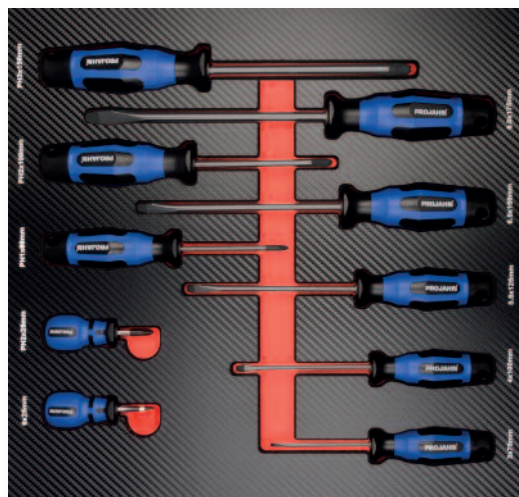

10
tlg./pcs.



395 x 375 x 35 mm



Art.-Nr./Art.-No.	tlg./pcs.	Inhalt/pcs.	L./L.	B./W.	H./H.	€
5999-481	10	PH 1 - 2 - 3, Vergaser-Schraubendreher/Carburetor Screwdriver PH2, Schlitz/Slotted 0,5 x 3,0 / 0,8 x 4,0 / 1,0 x 5,5 / 1,2 x 6,5 / 1,2 x 8,0 mm, Vergaser-Schraubendreher/Carburetor Screwdriver 6,5 x 25 mm				
5999-48E			395	375	35	Einlage leer/empty inlay

5999-061 **PROFESSIONAL** PLUS STANDARD

PROForm Einlegesystem Phillips- und Schlitz-Schraubendreher mit durchgehender Klinge und Schlagkappe, 6-teilig

PROForm Phillips and slotted Go-Through
Blade Screwdriver with Hammering Cap Inlay, 6 pieces

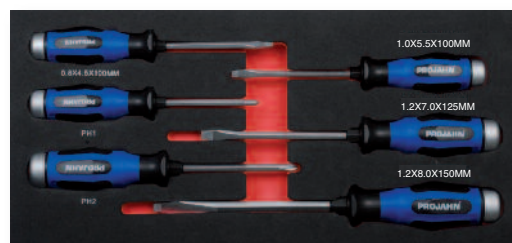

6
tlg./pcs.



395 x 186 x 35 mm



Art.-Nr./Art.-No.	tlg./pcs.	Inhalt/pcs.	L./L.	B./W.	H./H.	€
5999-061	6	PH 1 - 2 Schlitz 0,8 x 4,5 - 1,0 x 5,5 - 1,2 x 7,0 - 1,2 x 8,0			gemischt/mixed	
5999-06E			395	186	35	Einlage leer/empty inlay

5999-071 **PROFESSIONAL** PLUS STANDARD

PROForm Einlegesystem Phillips-, Pozidriv- und Schlitz-Schraubendreher, 8-teilig

PROForm Phillips-, Pozidriv- and Slotted Screwdriver Inlay, 8 pieces



8
tlg./pcs.



395 x 186 x 35 mm



Art.-Nr./Art.-No.	tlg./pcs.	Inhalt/pcs.	L./L.	B./W.	H./H.	€
5999-071	8	PH 1 - 2 - 3 PZ 1 - 2 - 3 Schlitz 1,2 x 6,5 - 1,6 x 8,0			gemischt/mixed	
5999-071E			395	186	35	Einlage leer/empty inlay

PROForm Werkstattwagen Einlagen

PROForm Inlays for Roller Cabinets

Art.-Gruppe 171
Article Group 171

5999-074 PROFESSIONAL PLUS STANDARD

PROForm Einlagesystem

Phillips-, Schlitz- und TORX-Schraubendreher, 8-teilig

PROForm Phillips, Slotted and TX Screwdriver Inlay, 8 pieces

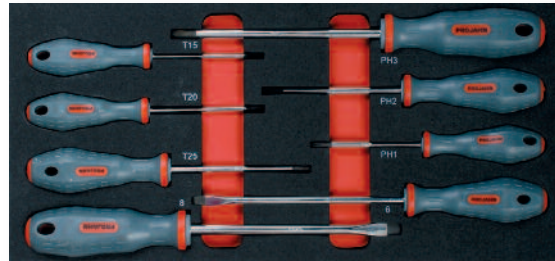

8
tlg./pcs.



395 x 186 x 35 mm



Art.-Nr./Art.-No.	tlg./pcs.	Inhalt/pcs.	L./L.	B./W.	H./H.	€
5999-074	8	PH 1 - 2 - 3, Schlitz 1,2 x 6,5 - 1,6 x 8,0, TX15 - 20 - 25			gemischt/mixed	
5999-074E			395	186	35	Einlage leer/empty

5999-072 PROFESSIONAL PLUS STANDARD

PROForm Einlagesystem

Innen-TORX-Schraubendreher, 8-teilig

PROForm TX Screwdriver Inlay, 8 pieces

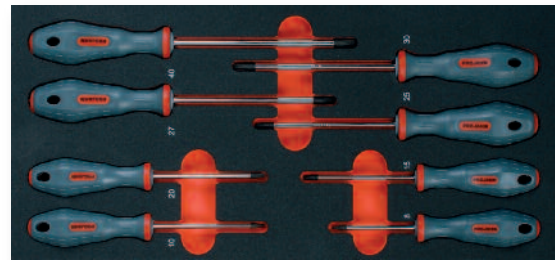

8
tlg./pcs.



395 x 186 x 35 mm



Art.-Nr./Art.-No.	tlg./pcs.	Inhalt/pcs.	L./L.	B./W.	H./H.	€
5999-072	8	T8 - T10 - T15 - T20 - T25 - T27 - T30 - T40			TX	
5999-072E			395	186	35	Einlage leer/empty inlay

5999-073 PROFESSIONAL PLUS STANDARD

PROForm Einlagesystem

Innen-TORX-Schraubendreher mit stirnseitiger Bohrung, 8-teilig

PROForm Tamper TX Screwdriver Inlay, 8 pieces

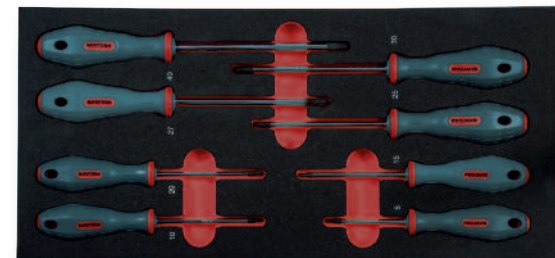

8
tlg./pcs.



395 x 186 x 35 mm



Art.-Nr./Art.-No.	tlg./pcs.	Inhalt/pcs.	L./L.	B./W.	H./H.	€
5999-073	8	T8 - T10 - T15 - T20 - T25 - T27 - T30 - T40			tamper TX	
5999-072E			395	186	35	Einlage leer/empty inlay

PROForm Werkstattwagen Einlagen

PROForm Inlays for Roller Cabinets

Art-Gruppe 171
Article Group 171

5999-341

PROFESSIONAL PLUS STANDARD

PROForm Einlegesystem

Kugelkopf T-Griff-Schraubendreher, 8-teilig

PROForm Ball End T-Handle Screwdriver Inlay, 8 pieces

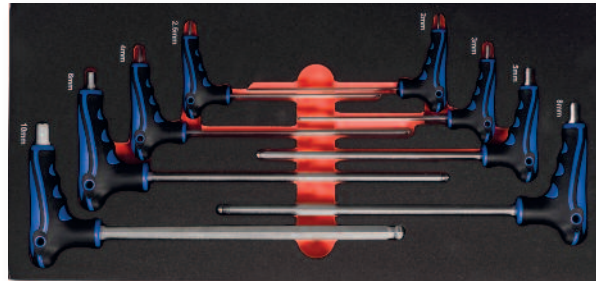

8
tlg./pcs.



395 x 186 x 35 mm



Art.-Nr./Art.-No.	tlg./pcs.	Inhalt/pcs.	L./L.	B./W.	H./H.	€
5999-341		8	2 - 2,5 - 3 - 4 - 5 - 6 - 8 - 10 mm		Kugelkopf/ball end	
5999-34E			395	186	35	Einlage leer/empty inlay

5999-351

PROFESSIONAL PLUS STANDARD

PROForm Einlegesystem

TX T-Griff-Schraubendreher, 9-teilig

PROForm TX T-Handle Screwdriver Inlay, 9 pieces

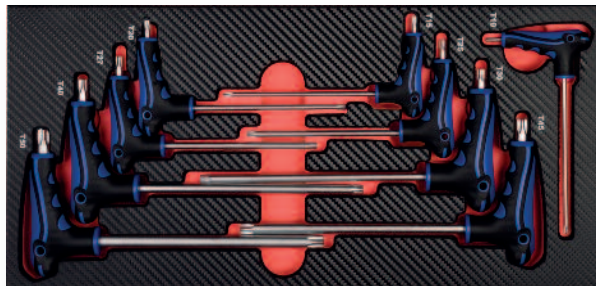

9
tlg./pcs.



395 x 186 x 35 mm



Art.-Nr./Art.-No.	tlg./pcs.	Inhalt/pcs.	L./L.	B./W.	H./H.	€
5999-351	9	T10 - T15 - T20 - T25 - T27 - T30 - T40 - T45 - T50			TX	
5999-35E			395	186	35	Einlage leer/empty inlay

5999-082

PROFESSIONAL PLUS STANDARD

PROForm Einlegesystem Zangen, 4-teilig

PROForm Pliers Inlay, 4 pieces

Inhalt/Contents:

Kombizange 180 mm,

Seitenschneider 160 mm,

Telefonzange 205 mm,

Wasserpumpenzange 250 mm



4
tlg./pcs.



395 x 186 x 35 mm

Combination Pliers 180 mm, Side Cutter 160 mm,

Long Nose Pliers 205 mm, Waterpump Pliers 250 mm

Art.-Nr./Art.-No.	tlg./pcs.	L./L.	B./W.	H./H.	€
5999-082	4				
5999-082E		395	186	35	Einlage leer/empty inlay

PROForm Werkstattwagen Einlagen

PROForm Inlays for Roller Cabinets

Art.-Gruppe 171
Article Group 171

5999-092 **PROFESSIONAL** PLUS STANDARD

PROForm Einlagesystem

Sicherungsringzangen, 4-teilig

PROFORM Circlip Pliers Inlay, 4 pieces

Inhalt/Contents:

Sicherungsringzangen A2 - A21 - J2 - J21

Circlip Pliers A2 - A21 - J2 - J21

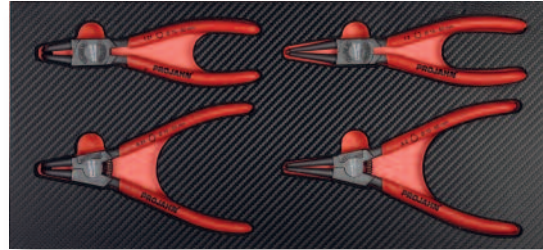

4
tlg./pcs.



395 x 186 x 35 mm

Art.-Nr./Art.-No.	tlg./pcs.	L./L.	B./W.	H./H.	€
5999-092	4				
5999-09E		395	186	35	Einlage leer/empty inlay

5999-091 **PROFESSIONAL** PLUS STANDARD

PROForm Einlagesystem

Sicherungsringzangen, 4-teilig

PROFORM Circlip Pliers Inlay, 4 pieces

Inhalt/Contents:

Sicherungsringzangen A2 - A21 - J2 - J21

Circlip Pliers A2 - A21 - J2 - J21



4
tlg./pcs.



395 x 186 x 35 mm

Art.-Nr./Art.-No.	tlg./pcs.	L./L.	B./W.	H./H.	€
5999-091	4				
5999-09E		395	186	35	Einlage leer/empty inlay

5999-161 **PROFESSIONAL** PLUS STANDARD

PROForm Einlagesystem Präzision, 45-teilig

PROForm Precision Tool Inlay, 45 pieces

Inhalt/Contents:

31-teilige Bit Box 4071, kurzer Bithalter 1/4" mit Schnellspannfutter, Elektronik-Flachzange, Elektronik-Rundzange, Elektronik-Kettenzange, Elektronik-Kettenzange 45°, Elektronik-Seitenschneider
Präzisionssschraubendrehersatz 8-teilig mit 14 Schrauberklinken

31 pieces Bit ox 4071, Short Bit Screwdriver with Quick Release, Electronic Flat Nose Pliers, Electronic Round Nose Pliers, Electronic Chain Nose Pliers, Electronic Chain Nose Pliers 45°, Electronic Side Cutter, Precision Screwdriver Set with 14 Different Sizes/Tips



45
tlg./pcs.



395 x 186 x 35 mm

Art.-Nr./Art.-No.	tlg./pcs.	L./L.	B./W.	H./H.	€
5999-161	4				
5999-16E		395	186	35	Einlage leer/empty inlay

PROForm Werkstattwagen Einlagen

PROForm Inlays for Roller Cabinets

Art.-Gruppe 171
Article Group 171

5999-461

PROFESSIONAL PLUS STANDARD

PROForm Einlegesystem Schlagwerkzeuge, 13-teilig

PROForm Hammer and Punch Inlay, 13 pieces

Inhalt/Contents:

Schlosserhammer 500 g, Splintentreiber Satz 2 – 8 mm,
5-teilig Schlagwerkzeuge-Satz inkl. Durchschlag, Körner,
Kreuz- und Flachmeißel, Cutter Messer mit einziehbarer Klinge,
Klingenbreite: 18 mm



13
tlg./pcs.

395 x 186 x 35 mm

Machinist Hammer 500 g, Pin Punches 2 – 8 mm,

5 pieces of Striking Tools including Taper and Center Punch, Bolt and Flat Chisel, Utility Knife with Rectangular Blade, Blade Width: 18 mm

Art.-Nr./Art.-No.	tlg./pcs.	L./L.	B./W.	H./H.	€
5999-461	13				
5999-46E		395	186	35	Einlage leer/empty inlay

5999-101

PROFESSIONAL PLUS STANDARD

PROForm Einlegesystem Schlagwerkzeuge, 6-teilig

PROForm Hammer and Punch Inlay, 6 pieces

Inhalt/Contents:

Schlosserhammer 500 g, Kunststoffhammer 35 cm,
Splintentreiber



6
tlg./pcs.

395 x 186 x 35 mm

Machinist Hammer 500 g, Dead-Blow Hammer 35 cm,

Pin Punches

Art.-Nr./Art.-No.	tlg./pcs.	L./L.	B./W.	H./H.	€
5999-101	6				
5999-10E		395	186	35	Einlage leer/empty inlay

5999-331

PROFESSIONAL PLUS STANDARD

PROForm Einlegesystem Feilen, 5-teilig

PROForm File Inlay, 5 pieces

Inhalt/Contents:

Flachfeile Hieb 2/200 mm, Halbrundfeile Hieb 2/200 mm,
Rundfeile Hieb 2/200 mm, Vierkantfeile Hieb 2/200 mm,
Dreikantfeile Hieb 2/200 mm

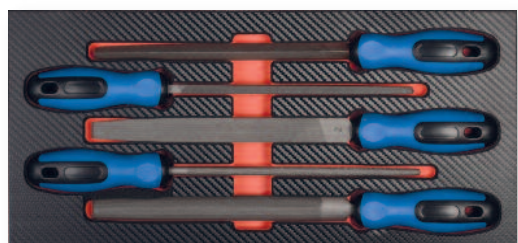

5
tlg./pcs.

395 x 186 x 35 mm

Flat File Hieb 2/200mm, Half Round File Hieb 2/200mm,

Round File Hieb 2/200mm, Three Square File Hieb 2/200mm,

Square File Hieb 2/200mm

Art.-Nr./Art.-No.	tlg./pcs.	L./L.	B./W.	H./H.	€
5999-331	5				
5999-33E		395	186	35	Einlage leer/empty inlay

PROForm Werkstattwagen Einlagen

PROForm Inlays for Roller Cabinets

Art.-Gruppe 171
Article Group 171

5999-451 PROFESSIONAL PLUS STANDARD

PROForm Einlagesystem VDE-Werkzeug, 13-teilig (Doppeleinlage)

PROForm VDE Screwdriver and VDE Pliers Inlay, 13 pieces (2/3-inlay)

Inhalt/Contents:

**VDE-Kombizange 180 mm, VDE-Seitenschneider 160 mm,
VDE-Kabelschneider 160 mm, VDE-Abisolierzange 160 mm,
VDE-Telefonzange 45° 200 mm, VDE-Telefonzange 200 mm,
Spannungsprüfer 3,5 x 90 mm,
VDE-Schraubendreher PH1, PH2, Schlitz 2,5 x 80 mm,
4,0 x 100 mm, 5,5 x 125 mm, 6,5 x 150 mm**

VDE Combination Pliers 180 mm, VDE Side Cutter 160 mm,
VDE Cable cutter 160 mm, VDE Wire Stripping Pliers 160 mm,
VDE Long nose pliers 45° 200 mm, VDE Long Nose Pliers 200 mm,
Voltage Tester 3,5 x 90 mm, VDE Screwdriver PH1, PH2,
VDE Slotted Screwdriver 2,5 x 80 mm,
4,0 x 100 mm, 5,5 x 125 mm, 6,5 x 150 mm

  **1000V**
EN 60900



13
tlg./pcs.

395 x 375 x 35 mm

Art.-Nr./Art.-No.	tlg./pcs.	L./L.	B./W.	H./H.	€
5999-451	13				
5999-45E		395	375	35	Einlage leer/empty inlay

5999-471 PROFESSIONAL PLUS STANDARD

PROForm Einlagesystem PROLine Zangen, 6-teilig (Doppeleinlage)

PROForm Screwdriver and Pliers Inlay, 13 pieces (2/3-inlay)

Inhalt/Contents:

**Flechtermetzze 260 mm,
Wasserpumpenzange 240 mm,
Gripzange 10"/250 mm, Telefonzange 205 mm,
Kombizange 180 mm, Seitenschneider 160 mm**

End Cutting Pliers 260 mm, Waterpump Wrench 240 mm,
Self Grip Pliers 10"/250 mm, Long Nose Pliers 205 mm,
Combination Pliers 180 mm, Side Cutter 160 mm



6
tlg./pcs.

395 x 375 x 35 mm

Art.-Nr./Art.-No.	tlg./pcs.	L./L.	B./W.	H./H.	€
5999-471	6				
5999-47E		395	375	35	Einlage leer/empty inlay

PROForm Werkstattwagen Einlagen

PROForm Inlays for Roller Cabinets

Art.-Gruppe 171
Article Group 171

5999-361

PROFESSIONAL PLUS STANDARD

PROForm Einlegesystem Gewindegewand-Werkzeug, 64-teilig (Doppeleinlage)

PROForm Tap and Die Tools Inlay, 64 pieces (2/3-inlay)

Inhalt/Contents:

Handgewindebohrer M3 - 4 - 5 - 6 - 8 - 10 - 12,
Schneideisen M3 - 4 - 5 - 6 - 8 - 10 - 12,
Windeisen verstellbar Nr. 1 - Nr. 2, Gewindegewand,
Schraubendreher, Werkzeughalter mit Knarre M5 - M12,
Schneideisenhalter 20x5 - 20x7 - 25x9 - 30x11 - 38x14 mm,
26 Stück Spiralbohrer HSS-G BASIC, 1 - 10,2 mm / 0,5 steigend,
inkl. Kernlochmaße

Hand Tap M3 - 4 - 5 - 6 - 8 - 10 - 12,
Circular Die M3 - 4 - 5 - 6 - 8 - 10 - 12,
Adjustable Tap Wrench No. 1 - No. 2, Tap Gauge,
Screwdriver, Tool-Holder with Ratchet M3 - M10,
Die Stock 20x5 - 20x7 - 25x9 - 30x11 - 38x14 mm,
HSS-G Twist Drill Bits BASIC, 1 - 10 mm / 0,5 Growing + 2,5 - 3,3 - 4,2 - 5,0 - 6,8 - 8,5 - 10,2 mm



64
tlg./pcs.

395 x 375 x 35 mm

Art.-Nr./Art.-No.	tlg./pcs.	L./L.	B./W.	H./H.	€
5999-361	64				
5999-36E		395	375	35	Einlage leer/empty inlay

5999-181

PROFESSIONAL PLUS STANDARD

PROForm Einlegesystem Schneid- und Mess-Werkzeug, 27-teilig (Dreifacheinlage)

PROForm Cutting and Measuring Tools Inlay,
27 pieces (3/3-inlay)

Inhalt/Contents:

Säge mit 5 Ersatz-Sägeblättern,
Messer mit 10 Ersatz-Klingen,
3 Blechscheren,
Hebel Kraft-Seitenschneider 180 mm,
Flechterszange 200 mm, Meßschieber,
Maßstab 1 m, Maßband 3 m,
Magnetheber, Taschenlampe

Hack Saw + 5 pieces Saw Blades,
Knive + 10 pieces Blades,
3 pieces Tinmans Shears,
Heavy Duty Side Cutter 180 mm, End Cutting Pliers 200 mm,
Vernier Caliper, Foldable Plastic Ruler 1m, Measuring Tape 3m, Magnetic Pick Up Tool, Flashlight



27
tlg./pcs.

395 x 560 x 35 mm

Art.-Nr./Art.-No.	tlg./pcs.	L./L.	B./W.	H./H.	€
5999-181	27				
5999-18E		395	560	35	Einlage leer/empty inlay

PROForm Werkstattwagen Einlagen

PROForm Inlays for Roller Cabinets

Art.-Gruppe 171
Article Group 171

5999-171

PROFESSIONAL PLUS STANDARD

PROForm Einlegesystem Gripzangen und Rollgabelschlüssel, 4-teilig

PROForm Rip Pliers

and Adjustable Wrenches Inlay, 4 pieces



4
tlg./pcs.



395 x 186 x 35 mm

Inhalt/Contents:

Rollgabelschlüssel 8"/200 mm, 12"/300 mm,
Gripzange 10"/250 mm,
Langbeck Klemmzange 150 mm

Adjustable Wrenches 8"/200 mm, 12"/300 mm,
Self Grip Pliers 10"/250 mm,
Long Jaws Grip Pliers 150 mm

Art.-Nr./Art.-No.	tlg./pcs.	L./L.	B./W.	H./H.	€
5999-171	4				
5999-17E		395	186	35	Einlage leer/empty inlay

5999-391 / 5999-392 / 5999-393

PROFESSIONAL PLUS STANDARD

Leereinlagen für Schrauben und andere Kleinteile

Empty Inlays for Screws and other Small Items

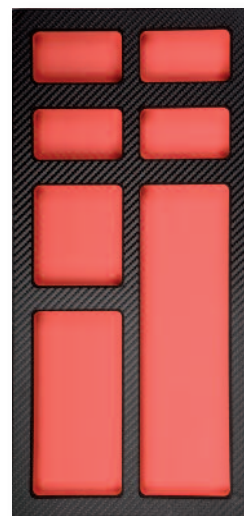
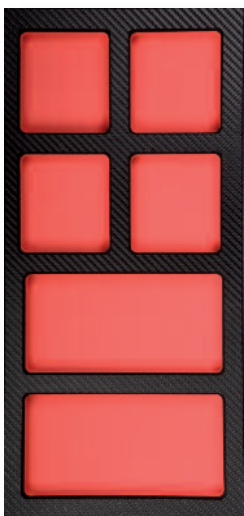

395 x 186 x 35 mm

NEU/NEW

Art.-Nr./Art.-No.	tlg./pcs.	L./L.	B./W.	H./H.	€
5999-391	6 Fächer/6 Compartments	395	186	35	Einlage leer/empty inlay
5999-392	5 Fächer/5 Compartments	395	186	35	Einlage leer/empty inlay
5999-393	7 Fächer/7 Compartments	395	186	35	Einlage leer/empty inlay

Bestückter Werkzeugkoffer »RedLine«, »BlackLine« oder »SuperBlue«

Sets for Tool Box »RedLine«, »BlackLine« or »SuperBlue«

Art.-Gruppe 172
Article Group 172

5902-01 / 5902-201 / 5902-501

PROFESSIONAL PLUS STANDARD

„Compact TS“

Werkzeugkoffer »RedLine«, »BlackLine« oder »SuperBlue«

bestückt mit 82 Werkzeugen in PROForm-Einlage

„Compact TS“ set for tool box »RedLine«, »BlackLine« or »SuperBlue« assembled with 82 tools in PROForm-inlay

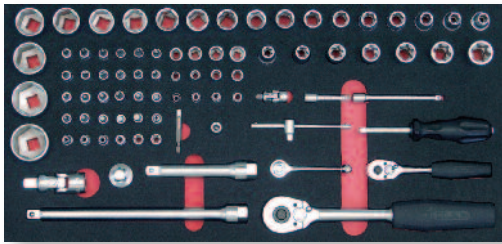

5999-211

269 x 568 x 35 mm



Art.-Nr./Art.-No.	Schubfächer/Drw.	L./L.	B./W.	H./H.	tlg./pcs.	€
5902-01	6 »RedLine«	307	660	378	82	bestückt „COMPACT TS“
5902-201	6 »BlackLine«	307	660	378	82	bestückt „COMPACT TS“
5902-501	6 »SuperBlue«	307	660	378	82	bestückt „COMPACT TS“

5902-02 / 5902-202 / 5902-502

PROFESSIONAL PLUS STANDARD

„Compact XL“

Werkzeugkoffer »RedLine«, »BlackLine« oder »SuperBlue«

bestückt mit 156 Werkzeugen in PROForm-Einlagen

„Compact XL“ sets for tool box »RedLine«, »BlackLine« or »SuperBlue«, assembled with 156 tools in PROForm-inlay

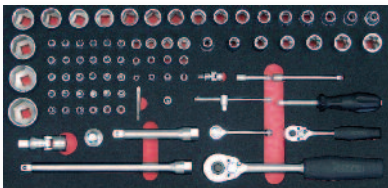

5999-211

269 x 568 x 35 mm



5999-221

269 x 568 x 35 mm



5999-231

269 x 568 x 35 mm

Art.-Nr./Art.-No.	Schubfächer/Drw.	L./L.	B./W.	H./H.	tlg./pcs.	€
5902-02	6 »RedLine«	307	660	378	156	bestückt „COMPACT XL“
5902-202	6 »BlackLine«	307	660	378	156	bestückt „COMPACT XL“
5902-502	6 »SuperBlue«	307	660	378	156	bestückt „COMPACT XL“

Einlagen zu Werkzeugkoffern

Inlays for Tool Boxes

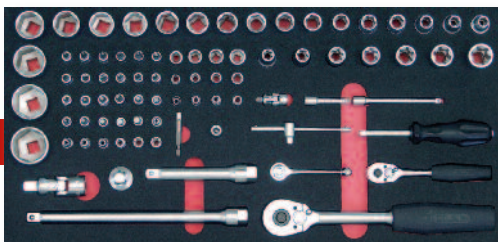

Art.-Gruppe 171
Article Group 171

PROFESSIONAL PLUS STANDARD

5999-211

269 x 568 x 35 mm

1/4"

Inhalt/Contents:

Knarre, Stubby Feinzahn-Umschaltknarre, Steckgriff, Gleitgriff, Verlängerungen 50 + 100 mm, Stecknuss Bit Adapter 50 mm, Kardangelenk, Kupplungsstück für Bits, Innen TX Nüsse E4 - 5 - 6 - 7 - 8 - 10 - 11, 6-kant Nüsse 4 - 4,5 - 5 - 5,5 - 6 - 7 - 8 - 9 - 10 - 11 - 12 - 13 mm, Bit Nüsse: PH1 - 2 - 3, PZ1 - 2 - 3, Schlitz 4 - 5,5 - 6,5 mm, TX8 - 9 - 10 - 15 - 20 - 25 - 27 - 30 - 40, Inbus 3 - 4 - 5 - 6 - 8 mm

Ratchet, Stubby Ratchet, Spinner Handle, Sliding T-Handle, Extension Bars 50 + 100 mm, Socket Adapter 50 mm, Universal Joint, Bit Adapter, TX Sockets E4 - 5 - 6 - 7 - 8 - 10 - 11, Sockets 4 - 4,5 - 5 - 5,5 - 6 - 7 - 8 - 9 - 10 - 11 - 12 - 13 mm, Bit Sockets: PH1 - 2 - 3, PZ1 - 2 - 3, Slotted 4 - 5,5 - 6,5 mm, TX8 - 9 - 10 - 15 - 20 - 25 - 27 - 30 - 40, Hex 3 - 4 - 5 - 6 - 8 mm

1/2"

Inhalt/Contents:

Knarre, T-Gleitadapter, Verlängerungen 125 + 250 mm, Kardangelenk, 6-kant Nüsse 8 - 9 - 10 - 11 - 12 - 13 - 14 - 15 - 16 - 17 - 18 - 19 - 20 - 21 - 22 - 24 - 27 - 30 - 32 mm, Innen-TX-Nüsse E12 - 14 - 16 - 18 - 20 - 22 - 24

Ratchet, T-Adapter, Extension Bars 125 + 250 mm, Universal Joint, Sockets 8 - 9 - 10 - 11 - 12 - 13 - 14 - 15 - 16 - 17 - 18 - 19 - 20 - 21 - 22 - 24 - 27 - 30 - 32 mm, TX Sockets E12 - 14 - 16 - 18 - 20 - 22 - 24

Art.-Nr./Art.-No.	L./L.	B./W.	H./H.	tlg./pcs.	€
5999-211	269	568	35	82	1/4" + 1/2" Einlage
5999-21E	269	568	35	1	Einlage leer

PROFESSIONAL PLUS STANDARD



5999-221

269 x 568 x 35 mm

Inhalt/Contents:

Schraubendreher Phillips Nr. 1 + 2, Pozidriv Nr. 1 + 2, Schlitz 0,5 x 3 x 75 mm, 0,8 x 4 x 100 mm, 1 x 5,5 x 125 mm, 1,2 x 6,5 x 150 mm, 1,6 x 8 x 150 mm, Kombizange 180 mm, Seitenschneider 160 mm, Telefon-/Radiozange 200 mm, Wasserpumpenzange 250 mm

Phillips Screwdriver No. 1 + 2, Pozidriv Screwdriver No. 1 + 2, Slotted Screwdriver 0,5 x 3 x 75 mm, 0,8 x 4 x 100 mm, 1 x 5,5 x 125 mm, 1,2 x 6,5 x 150 mm, 1,6 x 8 x 150 mm, Combination Plier 180 mm, Side Cutter 160 mm, Long Nose Plier 200 mm, Waterpump Plier 250 mm

PROFESSIONAL PLUS STANDARD



5999-231

269 x 568 x 35 mm

Inhalt/Contents:

Gabelringschlüssel 8 - 9 - 10 - 11 - 12 - 13 - 14 - 15 - 16 - 17 - 18 - 19 mm, Schlosserhammer 500 g, Splintentreiber-Satz 2 - 3 - 4 - 5 - 6 - 8 mm, Rollmeter 3 m, Universalmesser, Kugelkopf-Stiftschlüssel Satz extra lang 2 - 10 mm im Drehhalter, 1/4" BIT STOP Box (32-tlg.)

Combination Wrenches 8 - 9 - 10 - 11 - 12 - 13 - 14 - 15 - 16 - 17 - 18 - 19 mm, Machinist Hammer 500 g, Pin Punch Set 2 - 3 - 4 - 5 - 6 - 8 mm, Measuring Tape 3 m, Knife, Ball Point Keys Extra Long Version 2 to 10 mm, 1/4" BIT STOP Box (32 pieces)

Art.-Nr./Art.-No.	L./L.	B./W.	H./H.	tlg./pcs.	€
5999-221	269	568	35	13	Schraubendreher- u. Zangen- Einlage
5999-22E	269	568	35	1	Einlage leer
5999-231	269	568	35	61	Schlüssel- und Werkzeug-Einlage
5999-23E	269	568	35	1	Einlage leer

Sätze & Einzelteile

Socket Sets and Accessories



Sehr geehrter Kunde, PROJAHN liefert Ihnen stets eine gleichbleibend hohe Qualität. Um Ihnen die Suche nach dem für Ihre Anforderungen optimalen Werkzeug so einfach wie möglich zu machen, finden Sie über jedem Produkt das PROJAHN-Qualitätssiegel. Folgende Qualitätsstufen gliedern zukünftig das gesamte PROJAHN-Sortiment:

Dear Customer, PROJAHN always provides you with consistently high quality. To make the search for the optimal tool for your needs as easy as possible, you find the PROJAHN Quality Seal on each product. The following grades are dividing the entire PROJAHN range:

Höchste Qualitätsstufe / Highest Quality Level:

PROFESSIONAL PLUS STANDARD

Mittlere Qualitätsstufe / Medium Quality Level:

PROFESSIONAL PLUS STANDARD

Standard Qualitätsstufe / Standard Quality Level:

PROFESSIONAL PLUS STANDARD

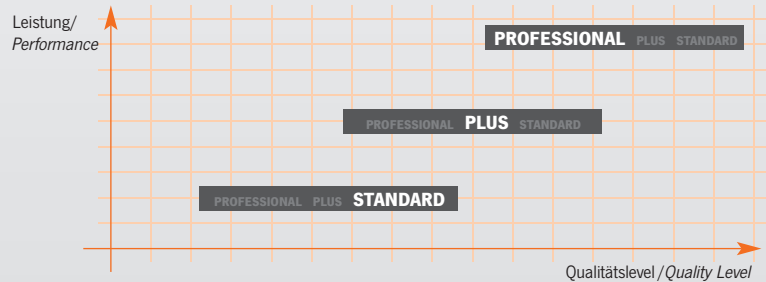

PROFESSIONAL

- ▶ Höchstes Qualitätsniveau für ausgezeichnete Präzision
- ▶ Übertrifft DIN- und ISO-Normen
- ▶ Für härteste Anwendungen bei geringem Verschleiß
- ▶ Sehr lange Lebensdauer
- ▶ Hochwertigste Materialien, professionelles Oberflächen-Finish
- ▶ Kompromisslose Qualität für höchste Ansprüche

PLUS

- ▶ Sehr hohes Qualitätsniveau für präzises Arbeiten
- ▶ Qualität über DIN- und ISO-Normen
- ▶ Werkzeuge für schwierige Anforderungen
- ▶ Für problemlösungsorientierte Anwender
- ▶ Hochwertige Herstellung, ergonomisches Design

STANDARD

- ▶ Gute Markenqualität
- ▶ Attraktiver Preis für Profi-Niveau
- ▶ Qualität für alle Standard-Anwendungen

PROFESSIONAL

- ▶ Highest level of quality for excellent precision
- ▶ Exceeds DIN and ISO standards
- ▶ For the hardest applications by low wear
- ▶ Very long life time
- ▶ High-quality materials, professional finish
- ▶ Uncompromising quality for highest demands

PLUS

- ▶ Very high level of quality for highest precision
- ▶ Quality higher than DIN and ISO standards
- ▶ Tools for difficult requirements
- ▶ For problem-solving users
- ▶ High-quality manufacturing, ergonomic design

STANDARD

- ▶ Good brand quality
- ▶ Attractive price-performance ratio
- ▶ Quality for all standard applications

Übersicht Werkzeugkoffer Summary Tool Cases

1

NEU/NEW



**1/4" Industrie-Steckschlüsselkoffer/
1/4" Industrial Socket Set**
Art.-Nr./Art.No. 3901401
B x L x H/W x L x H: 260 x 160 x 60 mm
Gewicht/Weight: 1.200 g

NEU/NEW



**1/4" Industrie-Steckschlüsselkoffer/
1/4" Industrial Socket Set**
Art.-Nr./Art.No. 3901402
B x L x H/W x L x H: 260 x 160 x 60 mm
Gewicht/Weight: 1.000 g



**1/4" Steckschlüsselkoffer US-Zoll/
1/4" Socket Set Inch**
Art.-Nr./Art.No. 4008
B x L x H/W x L x H: 260 x 135 x 45 mm
Gewicht/Weight: 1.360 g



**1/4" Xi-on Steckschlüssel-Satz/
1/4" Xi-on Socket Set**
Art.-Nr./Art.No. 4101
B x L x H/W x L x H: 225 x 125 x 45 mm
Gewicht/Weight: 1.100 g



**1/4" + 3/8" Durchschraubknarren-Satz/
1/4" + 3/8" Go-Through Socket Set**
Art.-Nr./Art.No. 4016
B x L x H/W x L x H: 245 x 122 x 45 mm
Gewicht/Weight: 1.200 g

NEU/NEW



**3D-Durchschraubset/
3D Go-Through Socket Set**
Art.-Nr./Art.No. 4017
B x L x H/W x L x H: 300 x 175 x 65 mm
Gewicht/Weight: 1.760 g

NEU/NEW



**1/4" Mini-Schlüssel und Bit-Box/
1/4" Mini Socket Set and Bit Box**
Art.-Nr./Art.No. 394072
B x L x H/W x L x H: 188 x 110 x 40 mm
Gewicht/Weight: 900 g



**1/4" MultiFit Steckschlüsselsatz/
1/4" MultiFit Socket Set**
Art.-Nr./Art.No. 8601
B x L x H/W x L x H: 166 x 85 x 35 mm
Gewicht/Weight: 660 g



**1/4" Steckschlüsselbox/
1/4" Socket Set**
Art.-Nr./Art.No. 4009
B x L x H/W x L x H: 245 x 128 x 40 mm
Gewicht/Weight: 1.260 g



**1/4" Steckschlüsselkoffer/
1/4" Socket Set**
Art.-Nr./Art.No. 8651
B x L x H/W x L x H: 245 x 180 x 60 mm
Gewicht/Weight: 1.250 g



**1/4" Steckschlüsselkoffer/
1/4" Socket Set**
Art.-Nr./Art.No. 8652
B x L x H/W x L x H: 245 x 180 x 60 mm
Gewicht/Weight: 1.250 g

Auf Seite / On Page	Qualität / Quality		Teile / Pieces	1/4"	3/8"	1/2"	3/4"	1"	Umschaltknarre / Ratchet Handle	Feinzahn-Umschaltknarre / Fine-Tooth Ratchet Handle	Durchsteck-Knarre / Go-Through Ratchet Handle	Tiefe Steckschlüsse / Deep Sockets	Zündkerzen-Stecknüsse / Spark Plug Sockets	Schlagnüsse / Impact Sockets	Tiefe Schlagnüsse / Deep Impact Sockets	Stecknuss-Bits / Bit Sockets	Standard-Bits / Bits	Doppelgabelschlüssel / Double Open End Wrench	Ringgabelschlüssel / Combination Wrench	Doppelringschlüssel / Double Ring Wrench	Gear Tech Ratschenschlüssel / GearTech Ratchet Wrench	Winkeltiftschlüssel / Hey Keys	Schraubendreher, Steckgriff / Screwdriver, Spinner Handle	Zangen / Pliers	Hammer / Hammer	Säge / Saw	Wasserwaage / Spirit Level	Feile, Raspel / File, Rasp	Stechbeitel / Wood Chisel
	PROFESSIONAL	PLUS																											
H 64	+		40	+					+		+					+							+						
H 64	+		39	+					+		+						+						+						
H 65	+		23	+					+		+	+																	
H 78		+	18	+						+	+													+					
H 80		+	25	+	+						+	+																	
H 80		+	17								+	+																	
H 81		+	38	+					+		+																		
H 81		+	28	+						+	+																		
H 82		+	15	+					+		+																		
H 84			46	+					+		+													+					
H 84			46	+					+		+													+					

Übersicht Werkzeugkoffer Summary Tool Cases

NEU/NEW

NEU/NEW

NEU/NEW

NEU/NEW

NEU/NEW

NEU/NEW

	Auf Seite / On Page	Qualität / Quality		Teile / Pieces	1/4"	3/8"	1/2"	3/4"	1"	Unschaltknaur / Ratchet Handle	Feinzahn-Unschaltknaur / Fine-Tooth Ratchet Handle	Durchsteck-Knaur / Go-Through Ratchet Handle	Stecknüsse / Sockets	Tiefe Stecknüsse / Deep Sockets	Zündkerzen-Stecknüsse / Spark Plug Sockets	Schlagnüsse / Impact Sockets	Tiefe Schlagnüsse / Deep Impact Sockets	Stecknuss-Bits / Bit Sockets	Standard-Bits / Bits	Doppelgabelschlüssel / Double Open Wrench	Ringgabelschlüssel / Combination Wrench	Doppelringeschlüssel / Double Ring Wrench	GearTech Ratschenschlüssel / GearTech Ratchet Wrench	Winkelstiftschlüssel / Hex Keys	Schraubendreher, Steckgriff / Screwdriver, Spinner Handle	Zangen / Pliers	Hammer / Hammer	Säge / Saw	Wasservaaqe / Spirit Level	Feile, Raspel / File, Rasp	Stechbeitel / Wood Chisel				
		PROFESSIONAL	PLUS																																
 <p>1/4" Mini-Steckschlüsselkoffer/ 1/4" Mini Socket Set Art.-Nr./Art.-No. 4078 B x L x H/W x L x H: 160 x 83 x 33 mm Gewicht/Weight: 450 g</p>	H 84		+	23	+					+																									
 <p>3/8" Industrie-Steckschlüsselkoffer/ 3/8" Industrial Socket Set Art.-Nr./Art.-No. 3903801 B x L x H/W x L x H: 400 x 290 x 80 mm Gewicht/Weight: 5.500 g</p>	H 66	+		76	+					+				+	+	+																			
 <p>3/8" Industrie-Steckschlüsselkoffer/ 3/8" Industrial Socket Set Art.-Nr./Art.-No. 3903802 B x L x H/W x L x H: 360 x 260 x 75 mm Gewicht/Weight: 2.100 g</p>	H 67	+		23	+					+				+	+																				
 <p>3/8" Steckschlüsselkoffer US-Zoll/ 3/8" Socket Set Inch Art.-Nr./Art.-No. 4018 B x L x H/W x L x H: 390 x 180 x 50 mm Gewicht/Weight: 3.340 g</p>	H 67	+		25	+					+				+	+	+																			
 <p>3/8" Xi-on Steckschlüssel-Satz/ 3/8" Xi-on Socket Set Art.-Nr./Art.-No. 4111 B x L x H/W x L x H: 260 x 145 x 50 mm Gewicht/Weight: 2.000 g</p>	H 78	+		17	+					+				+																					
 <p>1/2" Industrie-Steckschlüsselkoffer/ 1/2" Industrial Socket Set Art.-Nr./Art.-No. 3901201 B x L x H/W x L x H: 400 x 290 x 80 mm Gewicht/Weight: 5.100 g</p>	H 68	+		30	+					+				+	+																				
 <p>1/2" Industrie-Steckschl. 12-KANT/ 1/2" Industrial Socket Set 12 Point Art.-Nr./Art.-No. 3901202 B x L x H/W x L x H: 400 x 290 x 80 mm Gewicht/Weight: 5.100 g</p>	H 68	+		30	+					+				+	+																				
 <p>1/2" Industrie-Steckschlüsselkoffer/ 1/2" Industrial Socket Set Art.-Nr./Art.-No. 3901203 B x L x H/W x L x H: 360 x 260 x 75 mm Gewicht/Weight: 3.500 g</p>	H 69	+		20	+					+				+	+																				
 <p>1/2" Steckschlüsselkoffer US-Zoll/ 1/2" Socket Set Inch Art.-Nr./Art.-No. 4028 B x L x H/W x L x H: 450 x 275 x 55 mm Gewicht/Weight: 6.540 g</p>	H 69	+		28	+					+				+	+	+																			
 <p>1/2" Xi-on Steckschlüssel-Satz/ 1/2" Xi-on Socket Set Art.-Nr./Art.-No. 4121 B x L x H/W x L x H: 450 x 195 x 55 mm Gewicht/Weight: 4.530 g</p>	H 79	+		23	+					+				+																					
 <p>1/2" Kraftknauren-Steckschlüsselkoffer/ 1/2" Power Ratchet Socket Set Art.-Nr./Art.-No. 394020 B x L x H/W x L x H: 480 x 260 x 90 mm Gewicht/Weight: 5.500 g</p>	H 83	+		17	+					+				+																					

Übersicht Werkzeugkoffer Summary Tool Cases

3

NEU/NEW

NEU/NEW



NEU/NEW

NEU/NEW

NEU/NEW

Auf Seite / On Page	Qualität / Quality		Teile / Pieces	1/4"	3/8"	1/2"	3/4"	1"	Umschaltknarre / Ratchet Handle	Feinzahn-Umschaltknarre / Fine-Tooth Ratchet Handle	Durchsteck-Knarre / Go-Through Ratchet Handle	Stecknüsse / Sockets	Tiefe Stecknüsse / Deep Sockets	Zündkerzen-Stecknüsse / Spark Plug Sockets	Schlagnüsse / Impact Sockets	Tiefe Schlagnüsse / Deep Impact Sockets	Stecknuss-Bits / Bit Sockets	Standard-Bits / Bits	Doppelgabelschlüssel / Double Open End Wrench	Ringgabelschlüssel / Combination Wrench	Doppelring Schlüssel / Double Ring Wrench	GearTech Ratschenschlüssel / GearTech Ratchet Wrench	Winkelschlüssel / Hex Keys	Schraubendreher, Steckgriff / Screwdriver, Spinner Handle	Zangen / Pliers	Hammer / Hammer	Säge / Saw	Wasserväge / Spirit Level	Feile, Raspel / File, Rasp	Stechbettel / Wood Chisel		
	PROFESSIONAL	PLUS																														
 1/2" Spiralprofil-Steckschlüssel-Satz/ 1/2" Twist Socket Set Art.-Nr./Art.-No. 3061 B x L x H/W x L x H: 160 x 120 x 50 mm Gewicht/Weight: 750 g	H 83	+	10			+						+																				
 1/2" Steckschlüssel-Satz/ 1/2" Socket Set Art.-Nr./Art.-No. 8661 B x L x H/W x L x H: 300 x 230 x 70 mm Gewicht/Weight: 3.500 g	H 85		+	21		+			+																							
 1/2" Steckschlüssel-Satz/ 1/2" Socket Set Art.-Nr./Art.-No. 8662 B x L x H/W x L x H: 300 x 230 x 70 mm Gewicht/Weight: 3.500 g	H 85		+	21		+			+																							
 1/2" Steckschlüsselkoffer/ 1/2" Socket Set Art.-Nr./Art.-No. 4027 B x L x H/W x L x H: 450 x 190 x 55 mm Gewicht/Weight: 4.600 g	H 85		+	22		+			+																							
 3/4" Industrie-Steckschlüsselkoffer/ 3/4" Industrial Socket Set Art.-Nr./Art.-No. 3903401 B x L x H/W x L x H: 550 x 380 x 115 mm Gewicht/Weight: 15.000 g	H 71	+		21			+		+																							
 1" Industrie-Steckschlüsselkoffer/ 1" Industrial Socket Set Art.-Nr./Art.-No. 2052 B x L x H/W x L x H: 730 x 320 x 150 mm Gewicht/Weight: 40.340 g	H 72	+		22				+	+																							
 1/2" Industrie-Steckschlüsselkoffer/ 1/2" Industrial Socket Set Art.-Nr./Art.-No. 3901204 B x L x H/W x L x H: 400 x 290 x 100 mm Gewicht/Weight: 6.800 g	H 70	+		45		+			+												+											
 1/4" + 1/2" Industrie-Steckschlüsselkoffer/ 1/4" + 1/2" Industrial Socket Set Art.-Nr./Art.-No. 3904201 B x L x H/W x L x H: 400 x 290 x 100 mm Gewicht/Weight: 6.700 g	H 74	+		91	+	+			+								+	+					+									
 1/4" + 1/2" Xi-on Steckschlüssel-Satz/ 1/4" + 1/2" Xi-on Socket Set Art.-Nr./Art.-No. 4131 B x L x H/W x L x H: 450 x 200 x 55 mm Gewicht/Weight: 5.200 g	H 79	+		54	+	+			+								+						+									
 1/4" + 1/2" Steckschlüsselkoffer/ 1/4" + 1/2" Socket Set Art.-Nr./Art.-No. 8653 B x L x H/W x L x H: 380 x 295 x 80 mm Gewicht/Weight: 7.000 g	H 86		+	108	+	+			+								+	+					+	+								
 1/4" + 1/2" Steckschlüsselkoffer/ 1/4" + 1/2" Socket Set Art.-Nr./Art.-No. 8654 B x L x H/W x L x H: 380 x 295 x 80 mm Gewicht/Weight: 7.000 g	H 86		+	108	+	+			+								+	+					+	+								

Übersicht Werkzeugkoffer Summary Tool Cases





	Auf Seite / On Page	Qualität / Quality		Teile / Pieces	1/4"	3/8"	1/2"	3/4"	1"	Unschaltknarre / Ratchet Handle	Feinzahn-Unschaltknarre / Fine-Tooth Ratchet Handle	Durchsteck-Knarre / Go-Through Ratchet Handle	Stecknüsse / Sockets	Tiefe Stecknüsse / Deep Sockets	Zündkerzen-Stecknüsse / Spark Plug Sockets	Schlagnüsse / Impact Sockets	Tiefe Schlagnüsse / Deep Impact Sockets	Stecknuss-Bits / Bit Sockets	Standard-Bits / Bits	Doppelgabelschlüssel / Double Open End Wrench	Ringgabelschlüssel / Combination Wrench	Doppelringschlüssel / Double Ring Wrench	GearTech Ratschenschlüssel / GearTech Ratchet Wrench	Winkelstiftschlüssel / Hex Keys	Schraubendreher + Steckgriff / Screwdriver + Spinner Handle	Zangen / Pliers	Hammer / Hammer	Säge / Saw	Wasservaage / Spirit Level	Feile, Raspel / File, Rasp	Stechbeitel / Wood Chisel		
		PROFESSIONEL	PLUS																														
NEU/NEU  1/4" + 3/8" + 1/2" Steckschlüsselkoffer/ 1/4" + 3/8" + 1/2" Socket Set Art.-Nr./Art.-No. 8663 B x L x H/W x L x H: 400 x 310 x 82 mm Gewicht/Weight: ca. 8.500 g	H 88	+	182	+	+	+				+			+	+	+									+	+								
NEU/NEU  1/4" + 3/8" + 1/2" Steckschlüsselkoffer/ 1/4" + 3/8" + 1/2" Socket Set Art.-Nr./Art.-No. 8664 B x L x H/W x L x H: 400 x 310 x 82 mm Gewicht/Weight: ca. 8.500 g	H 88		182	+	+	+				+															+	+							
NEU/NEU  3/8" Universal Werkzeugkoffer/ 3/8" Universal Tool Set Art.-Nr./Art.-No. 3903803 B x L x H/W x L x H: 550 x 380 x 115 mm Gewicht/Weight: 7.800 g	H 73	+	84		+					+			+		+					+	+			+	+	+	+	+	+	+	+		
NEU/NEU  1/2" Universal Werkzeugkoffer/ 1/2" Universal Tool Set Art.-Nr./Art.-No. 3901205 B x L x H/W x L x H: 460 x 350 x 90 mm Gewicht/Weight: 6.900 g	H 75	+	67			+				+			+		+					+	+				+	+	+	+	+	+	+		
NEU/NEU  1/4" + 3/8" + 1/2" Industrie-Steckschl./ 1/4" + 3/8" + 1/2" Industrial Socket Set Art.-Nr./Art.-No. 39048201 B x L x H/W x L x H: 550 x 380 x 115 mm Gewicht/Weight: 10.500 g	H 76	+	122	+	+	+				+			+							+	+			+	+	+							
NEU/NEU  1/4" + 3/8" + 1/2" Industrie-Steckschlüssel./ 1/4" + 3/8" + 1/2" Industrial Socket Set Art.-Nr./Art.-No. 39048202 B x L x H/W x L x H: 550 x 380 x 115 mm Gewicht/Weight: 13.500 g	H 77	+	195	+	+	+				+			+	+	+	+	+	+	+	+	+			+	+								
NEU/NEU  1/4" + 1/2" Werkzeugkoffer/ 1/4" + 1/2" Tool Set Art.-Nr./Art.-No. 8655 B x L x H/W x L x H: 420 x 285 x 85 mm Gewicht/Weight: 6.000 g	H 87		91	+	+					+			+							+	+			+	+	+							
NEU/NEU  1/4" + 1/2" Werkzeugkoffer/ 1/4" + 1/2" Tool Set Art.-Nr./Art.-No. 8656 B x L x H/W x L x H: 420 x 285 x 85 mm Gewicht/Weight: 6.000 g	H 87		91	+	+					+			+							+	+			+	+	+							
NEU/NEU  1/2" Metall-Werkzeugkoffer/ 1/2" Metal Tool Set Art.-Nr./Art.-No. 8688 B x L x H/W x L x H: 490 x 225 x 380 mm Gewicht/Weight: 13.500 g	H 89		84		+					+			+		+					+	+			+	+	+	+	+	+	+	+	+	
NEU/NEU  1/4" + 1/2" Universal-Werkzeug-Trolley/ 1/4" + 1/2" Universal Tool Trolley Art.-Nr./Art.-No. 4963-01 B x L x H/W x L x H: 450 x 390 x 170 mm Gewicht/Weight: 17.500 g	H 91		130	+	+					+			+							+	+			+	+	+	+	+	+	+	+	+	
NEU/NEU  1/4" + 1/2" Universal-Werkzeug-Koffer/ 1/4" + 1/2" Universal Tool Case Art.-Nr./Art.-No. 8681 B x L x H/W x L x H: 460 x 330 x 145 mm Gewicht/Weight: 12.240 g	H 90		149	+	+					+			+							+	+			+	+	+	+	+	+	+	+	+	

Übersicht Werkzeugkoffer

Summary Tool Cases

5

NEU/NEW

Auf Seite / On Page	Qualität / Quality		Teile / Pieces					Umschaltknarre / Ratchet Handle	Feinzahn-Umschaltknarre / Fine-Tooth Ratchet Handle	Durchsteck-Knarre / Go-Through Ratchet Handle	Tiefe Stecknüsse / Deep Sockets	Zündkerzen-Stecknüsse / Spark Plug Sockets	Schlagnüsse / Impact Sockets	Tiefe Schlagnüsse / Deep Impact Sockets	Stecknuss-Bits / Bit-Sockets	Standard-Bits / Bits	Doppelgabelschlüssel / Double Open End Wrench	Ringgabelschlüssel / Combination Wrench	Doppelringschlüssel / Double Ring Wrench	GearTech Ratschenschlüssel / GearTech Ratchet Wrench	Winkelschlüssel / Hex Keys	Schraubendreher + Steckgriff / Screwdriver + Spinner Handle	Zangen / Pliers	Hammer / Hammer	Säge / Saw	Wasserwaage / Spirit Level	Feile, Raspel / File, Rasp	Stechbeitel / Wood Chisel					
	PROFESSIONEL	PLUS	STANDARD	1/4"	3/8"	1/2"	3/4"																						1"				
 <p>3/8" Universal-Werkzeug-Koffer/ 3/8" Universal Tool Case Art.-Nr./Art.No. 8682 B x L x H/W x L x H: 425 x 280 x 130 mm Gewicht/Weight: 9.400 g</p>	H		+	164	+			+								+	+				+	+	+	+	+	+							
 <p>1/4" + 1/2" Elektro-Werkzeug-Koffer/ 1/4" + 1/2" Electrician Tool Case Art.-Nr./Art.No. 8683 B x L x H/W x L x H: 460 x 330 x 145 mm Gewicht/Weight: 10.200 g</p>	H	XX	+	128	+	+		+								+	+				+	+	+	+	+	+							
 <p>1/4" Schreiner-Werkzeug-Koffer/ 1/4" Carpenter Tool Case Art.-Nr./Art.No. 8684 B x L x H/W x L x H: 460 x 330 x 145 mm Gewicht/Weight: 9.060 g</p>	H	XX	+	92	+											+	+				+	+	+	+	+	+	+	+	+	+			
 <p>1/2" Sanitär-Werkzeug-Koffer/ 1/2" Plumber Tool Case Art.-Nr./Art.No. 8685 B x L x H/W x L x H: 460 x 330 x 145 mm Gewicht/Weight: 12.760 g</p>	H	XX	+	95	+	+		+		+						+	+				+	+	+	+	+	+	+	+	+	+			
 <p>1/4" Werkzeugtasche/ 1/4" Tool Bag Art.-Nr./Art.No. 8686 B x L x H/W x L x H: 340 x 440 x 250 mm Gewicht/Weight: 7.200 g</p>	H	XX	+	106	+			+		+					+	+	+				+	+	+	+									



Profi-Qualität

Professional Quality

- ▶ **Höchstes Qualitätsniveau für anspruchsvolle Anwender**
- ▶ **Präzision und Belastbarkeit weit über DIN-/ISO-Normen**
- ▶ **Ergonomisch optimiertes Kofferdesign – 2K-Koffergriff und klar strukturierte Anordnung der Werkzeuge**
- ▶ **Optimiert auf Langlebigkeit für höchste Ansprüche**
- ▶ *Highest level of quality for demanding users*
- ▶ *Precision and durability far beyond DIN/ISO standards*
- ▶ *Ergonomically optimized design – 2K-handle and clearly structured arrangement of the tools*
- ▶ *Optimized for durability for highest demands*

Einzigartiges Produktportfolio

Unique Product Range

- ▶ **Breites Produktsortiment für verschiedenste Anwendungen**
- ▶ **14 professionelle Werkzeugkoffer optimiert für individuelle Ansprüche**
- ▶ **Innovative, zukunftsorientierte Werkzeugzusammenstellung**
- ▶ *Wide product range enables universal use*
- ▶ *14 professional tool sets optimized for individual requirements*
- ▶ *Innovative and future-oriented assortment of tools*

Exklusive Persönlichkeit

Exclusive Personality

- ▶ **Hochwertige, ausdrucksstarke Premium-Optik**
- ▶ **Langlebige und stabile Design-Metallverschlüsse**
- ▶ **Werkzeuge passgenau eingebettet in Schaumeinlagen mit attraktiver metallischer Oberflächenoptik**
- ▶ *High-quality, expressive premium-look*
- ▶ *Durable and stable design metal locks*
- ▶ *Tools perfectly embedded in foam insert with attractive metallic surface appearance*

Leistungstarker Service

Powerful Support

- ▶ **PROJAHN Qualitätsversprechen – 25 Jahre Garantie¹**
- ▶ **Alle Einzelteile problemlos nachbestellbar**
- ▶ **Inklusive Servicezertifikat**
- ▶ **Qualifizierte Produktberatung**
- ▶ *PROJAHN's promise of quality – 25 years warranty¹*
- ▶ *All individual parts easily orderable*
- ▶ *Including certificate of service*
- ▶ *Qualified product advice*

¹ Entsprechend unserer allgemeinen Garantiebedingungen
¹ According to our general warranty conditions





Ergonomisches Design

Ergonomic Design

- ▶ **Sicherer Halt und ermüdungsfreies Arbeiten durch ergonomisch an die Hand angepasste Griffform**
- ▶ **2-Komponentenmaterial – bruchsicher, stabiler Kern und griffige Ummantelung mit hoher Rutschhemmung**
- ▶ **Hoher Abgleitschutz durch spezielle Daumenmulden**
- ▶ **Geringere Belastung für Gelenke bei gleichzeitig höherem Drehmoment**
- ▶ **Leichte Einhandbedienung durch Schnelllöseknopf und Richtungsumschalter**
- ▶ *Secure grip and fatigue-free working due to ergonomically to the hand designed ratchet handle*
- ▶ *Two-component material – robust core combined with an ergonomic, slip-resistant surface*
- ▶ *High slip protection due to specially adapted thumb grips*
- ▶ *Less strain on joints combined with a higher torque*
- ▶ *Easy one-handed operation because of quick-release button and direction lever*

EINGETRAGENES DESIGN

REGISTERED DESIGN



Profi-Qualität

Professional Quality

- ▶ **Höchstes Qualitätsniveau für anspruchsvolle Anwender**
- ▶ **Präzision und Belastbarkeit weit über DIN-/ISO-Normen**
- ▶ **Hält extremen Drehmomenten bis 650 Nm stand²**
- ▶ **Leichtgängiger, hochpräziser Knarrenmechanismus**
- ▶ **Hohe Öl- und Säurebeständigkeit**
- ▶ *Highest level of quality for demanding users*
- ▶ *Precision and durability far beyond DIN/ISO standards*
- ▶ *Withstands extreme torques up to 650 Nm⁽²⁾*
- ▶ *Smooth-running, high-precision ratchet mechanism*
- ▶ *High oil and acid resistance*



Leistungstarker Service

Powerful Support

- ▶ **PROJAHN Qualitätsversprechen – 25 Jahre Garantie¹**
- ▶ **Schneller Reparaturservice im Garantiefall**
- ▶ *PROJAHN's promise of quality – 25 years warranty¹*
- ▶ *Fast repair service during warranty time*



¹ Entsprechend unserer allgemeinen Garantiebedingungen / ¹ According to our general warranty conditions

² 1/2" PROJAHN-Umschaltknarre 39012900 / ² PROJAHN ratchet handle 39012900

1/4" Industrie-Steckschlüssel- koffer, 40-teilig

1/4" Industrial Socket Set, 40 pieces



Art.-Gruppe 110
Article Group 110

3901401

1/4"

40
tlg./pcs.

NEU/NEW



Industrie-Steckschlüsselkoffer mit 40 Werkzeugen, metrisch

- ▶ PROJAHN Umschaltknarre
- ▶ Stecknüsse 3,5 – 14 mm
- ▶ Bit-Schraubereinsätze für alle Schraubarbeiten
- ▶ Ergonomischer Steckgriff

Industrial socket set with 40 assorted tools, metric

- ▶ PROJAHN ratchet handle, reversible
- ▶ Sockets 3.5 – 14 mm
- ▶ Bit-sockets for all screws
- ▶ Ergonomical spinner handle

14	○	3.5 - 4 - 4.5 - 5 - 5.5 - 6 - 7 - 8 - 9 - 10 - 11 - 12 - 13 - 14 mm	
3	●	4 - 5.5 - 6.5 mm	
3	+	PH 1 - 2 - 3	
3	+	PZ 1 - 2 - 3	
5	●	3 - 4 - 5 - 6 - 8 mm	
6	●	T10 - 15 - 20 - 25 - 30 - 40	
1		Art. 39014900	
1		Steckgriff	
2		Verlängerung 50 + 100 mm	
1		Gleitgriff	
1		Kardangelenke	



Größe/Size 1/4"
tlg./pcs. 40
BxLxH/WxLxH 260x160x60 mm
Gewicht/Weight 1.200 g

1/4" Industrie-Steckschlüssel- koffer 39-teilig

1/4" Industrial Socket Set, 39 pieces



Art.-Gruppe 110
Article Group 110

3901402

1/4"

39
tlg./pcs.

NEU/NEW



Industrie-Steckschlüsselkoffer mit 39 Werkzeugen, metrisch

- ▶ PROJAHN Umschaltknarre, Stecknüsse 3,5 – 14 mm
- ▶ Bits für jeden Einsatz, Stecknuss-Bit-Adapter
- ▶ Magnetischer Bit-Schraubendreher

Industrial socket set with 39 assorted tools, metric

- ▶ PROJAHN ratchet handle, reversible, sockets 3.5 – 14 mm
- ▶ Bits for all screws, adapter-bit for socket
- ▶ Magnetic spinner handle

14	○	3.5 - 4 - 4.5 - 5 - 5.5 - 6 - 7 - 8 - 9 - 10 - 11 - 12 - 13 - 14 mm	
2	●	5.5 - 6.5 mm	
3	+	PH 1 - 2 - 3	
3	+	PZ 1 - 2 - 3	
5	●	3 - 4 - 5 - 6 - 8 mm	
6	●	T10 - 15 - 20 - 25 - 30 - 40	
1		Adapter 1/4" (Knarre) x 1/4" (Bit)	
1		Art. 39014900	
1		Magn. Bitschraubendreher	
1		Verlängerung 100 mm	
1		Kardangelenke	
1		1/4" Stecknuss-Bit-Adapter	



Größe/Size 1/4"
tlg./pcs. 39
BxLxH/WxLxH 260x160x60 mm
Gewicht/Weight 1.000 g

Art.-Nr./Art.-No.	€
3901401	1/4" Industrie-Steckschlüsselkoffer
3901402	1/4" Industrie-Steckschlüsselkoffer

**1/4" Steckschlüsselkoffer,
23-teilig, US-Zoll**

1/4" Socket Set, 23 pieces, Inch



Art.-Gruppe 110
Article Group 110

4008





**Industrie-Steckschlüsselkoffer mit 23 Werkzeugen,
Zoll im Metallkoffer**

- ▶ Industrieknarre
- ▶ Stecknüsse 3/16" – 1/2"
- ▶ Tiefe Stecknüsse 3/16" – 1/2"

Industrial socket set with 23 assorted tools,
inch in metal case

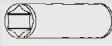
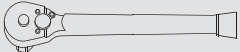
- ▶ Industrial ratchet
- ▶ Sockets 3/16" – 1/2"
- ▶ Deep sockets 3/16" – 1/2"

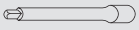
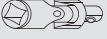
9	○ 3/16" - 7/32" - 1/4" - 9/32" - 5/16" - 11/32" - 3/8" - 7/16" - 1/2"	
9	○ 3/16" - 7/32" - 1/4" - 9/32" - 5/16" - 11/32" - 3/8" - 7/16" - 1/2"	
1	Art. 4208	
1	Steckgriff	
2	Verlängerung 2" + 3"	
1	Kardangelenk	

Größe/Size: 1/4" · **tlg./pcs.** 23 · **BxLxH/WxLxH:** 260x135x45 mm
Gewicht/Weight: 1.360 g

Art.-Nr./Art.-No.	€
4008	1/4" Steckschlüsselkoffer US-Zoll

3/8" Industrie-Steckschlüsselkoffer, 76-teilig

3/8" Socket Set, 76 pieces



Art-Gruppe 110
Article Group 110

3903801

3/8"

76
tlg./pcs.

NEU/NEW



Industrie-Steckschlüsselkoffer mit 76 Werkzeugen, metrisch

- ▶ PROJAHN Umschaltknarre
- ▶ Stecknüsse 6 – 24 mm
- ▶ Tiefe Stecknüsse 8 – 22 mm
- ▶ Bit-Stecknüsse für alle Schraubarbeiten

Industrial socket set with 76 assorted tools, metric

- ▶ PROJAHN ratchet handle, reversible
- ▶ Sockets 6 – 24 mm
- ▶ Deep sockets 8 – 22 mm
- ▶ Bit-sockets for all screws

19	○	6 - 7 - 8 - 9 - 10 - 11 - 12 - 13 - 14 - 15 - 16 - 17 - 18 - 19 - 20 - 21 - 22 - 23 - 24 mm		7	●	3 - 4 - 5 - 6 - 7 - 8 - 10 mm	
11	○	8 - 10 - 11 - 12 - 13 - 14 - 15 - 17 - 18 - 19 - 22 mm		10	⊕	T10 - 15 - 20 - 25 - 27 - 30 - 40 - 45 - 50 - 55	
2	○	16 + 21 mm		10	⊗	T10 - 15 - 20 - 25 - 27 - 30 - 40 - 45 - 50 - 55	
4	●	5.5 - 6.5 - 8 - 10 mm		1		1/2" (Knarre) x 3/8" (Nuss)	
4	+	PH 1 - 2 - 3 - 4		2		Verlängerungen 75 + 250 mm	
4	+	PZ 1 - 2 - 3 - 4		1		Kardangelen	
				1		Art. 39038900	



Größe/Size 3/8"
 tlg./pcs. 76
 BxLxH/WxLxH 400x290x80 mm
 Gewicht/Weight 5.600 g

Art.-Nr./Art.-No.		€
3903801	3/8" Industrie-Steckschlüsselkoffer	

3/8" Industrie-Steckschlüsselkoffer, 23-teilig

3/8" Socket Set, 23 pieces



Art.-Gruppe 110
Article Group 110

3903802



NEU/NEW



23
tlg./pcs.

Industrie-Steckschlüsselkoffer mit 23 Werkzeugen, metrisch

- ▶ PROJAHN Umschaltknarre
- ▶ Stecknüsse 6 – 22 mm
- ▶ Zündkerzen Stecknüsse 16 + 21 mm
- ▶ Verlängerungen 75 + 250 mm

Industrial socket set with 23 assorted tools, metric

- ▶ PROJAHN ratchet handle, reversible
- ▶ Sockets 6 – 22 mm
- ▶ Spark plug sockets 16 + 21 mm
- ▶ Extension bars 75 + 250 mm

17	○	6 - 7 - 8 - 9 - 10 - 11 - 12 - 13 - 14 - 15 - 16 - 17 - 18 - 19 - 20 - 21 - 22 mm	
2	○	16 + 21 mm	
1		Art. 39038900	
2		Verlängerungen 75 + 250 mm	
1		1/2" (Knarre) x 3/8" (Nuss)	



Größe/Size 3/8"
tlg./pcs. 23
BxLxH/WxLxH 360x260x75 mm
Gewicht/Weight 2.100 g

Art.-Nr./Art.-No. 3903802 3/8" Industrie-Steckschlüsselkoffer €

3/8" Steckschlüsselkoffer, 25-teilig, US-Zoll

3/8" Socket Set, 25 pieces, Inch



Art.-Gruppe 110
Article Group 110

4018

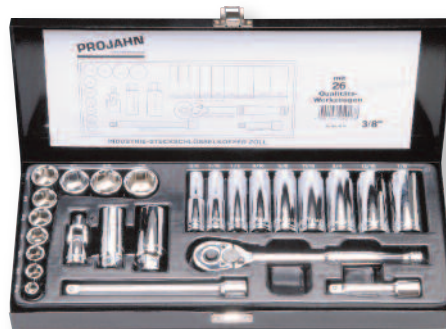

25
tlg./pcs.

Industrie-Steckschlüsselkoffer mit 25 Werkzeugen, Zoll, im Metallkoffer

Industrial socket set with 25 assorted tools, inch, in metal case

10	○	5/16" - 3/8" - 7/16" - 1/2" - 9/16" - 5/8" - 11/16" - 3/4" - 13/16" - 7/8"	
9	○	3/8" - 7/16" - 1/2" - 9/16" - 5/8" - 11/16" - 3/4" - 13/16" - 7/8"	
2	○	5/8" + 13/16"	
1		Art. 4218	
2		Verlängerungen 3" + 6"	
1		Kardangelenke	

Größe/Size: 3/8" · **tlg./pcs.** 25 · **BxLxH/WxLxH:** 390x180x50 mm
Gewicht/Weight: 3.340 g

Art.-Nr./Art.-No. 4018 3/8" Steckschlüsselkoffer US-Zoll €

1/2" Industrie-Steckschlüssel- koffer, 30-teilig

1/2" Socket Set, 30 pieces

PROJAHN
PROFESSIONAL

Art.-Gruppe 110
Article Group 110

3901201

1/2"

30
tlg./pcs.

NEU/NEW

GARANTIE
25
JAHRE



Industrie-Steckschlüsselkoffer mit 30 Werkzeugen,
metrisch

- ▶ PROJAHN Umschaltknarre
- ▶ Stecknüsse 8 – 34 mm
- ▶ Zündkerzen Stecknüsse 16 + 21 mm
- ▶ Verlängerungen 125 + 250 mm
- ▶ Kardangelen

Industrial socket set with 30 assorted tools, metric

- ▶ PROJAHN ratchet handle, reversible
- ▶ Sockets 8 – 34 mm
- ▶ Spark plug sockets 16 + 21 mm
- ▶ Extension bars 125 + 250 mm
- ▶ Universal joint

23 ○ 8 - 9 - 10 - 11 - 12 - 13 - 14 - 15 -
16 - 17 - 18 - 19 - 20 - 21 - 22 - 23 -
24 - 26 - 27 - 28 - 30 - 32 - 34 mm



2 ○ 16 + 21 mm

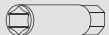

1 Art. 39012900



2 Verlängerungen 125 + 250 mm

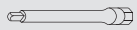

1 1/2" (Knarre) x 1/2" (Nuss)



1 Kardangelen



Größe/Size 1/2"
tlg./pcs. 30
BxLxH/WxLxH 400x290x80 mm
Gewicht/Weight 5.100 g

Art.-Nr./Art.-No. 3901201 1/2" Industrie-Steckschlüsselkoffer €

1/2" Industrie-Steckschlüssel- koffer 12-KANT, 30-teilig

1/2" Socket Set 12 POINT, 30 pieces

PROJAHN
PROFESSIONAL

Art.-Gruppe 110
Article Group 110

3901202

1/2"

30
tlg./pcs.



NEU/NEW

GARANTIE
25
JAHRE



12-KANT

Industrie-Steckschlüsselkoffer mit 30 Werkzeugen,
metrisch 12-KANT

- ▶ PROJAHN Umschaltknarre
- ▶ Stecknüsse 8 – 34 mm
- ▶ Zündkerzen Stecknüsse 16 + 21 mm
- ▶ Verlängerungen 125 + 250 mm
- ▶ Kardangelen

Industrial socket set with 30 assorted tools,
metric 12 POINT sockets

- ▶ PROJAHN ratchet handle, reversible
- ▶ Sockets 8 – 34 mm
- ▶ Spark plug sockets 16 + 21 mm
- ▶ Extension bars 125 + 250 mm
- ▶ Universal joint

23 ● 8 - 9 - 10 - 11 - 12 - 13 - 14 - 15 - 16 -
17 - 18 - 19 - 20 - 21 - 22 - 23 - 24 -
26 - 27 - 28 - 30 - 32 - 34 mm



2 ○ 16 + 21 mm



1 Art. 39012900

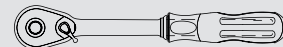

2 Verlängerungen 125 + 250 mm

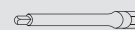

1 1/2" (Knarre) x 1/2" (Nuss)



1 Kardangelen



Größe/Size 1/2"
tlg./pcs. 30
BxLxH/WxLxH 400x290x80 mm
Gewicht/Weight 5.100 g

Art.-Nr./Art.-No. 3901202 1/2" Industrie-Steckschlüsselkoffer €

1/2" Industrie-Steckschlüsselkoffer, 20-teilig

1/2" Socket Set, 20 pieces



Art.-Gruppe 110
Article Group 110

3901203

1/2"

20
tlg./pcs.

NEU/NEW



Industrie-Steckschlüsselkoffer mit 20 Werkzeugen, metrisch

- ▶ PROJAHN Umschaltknarre
- ▶ Stecknüsse 10 – 32 mm
- ▶ Zündkerzen Stecknüsse 16 + 21 mm
- ▶ Verlängerungen 125 + 250 mm

Industrial socket set with 20 assorted tools, metric

- ▶ PROJAHN ratchet handle, reversible
- ▶ Sockets 10 – 32 mm
- ▶ Spark plug sockets 16 + 21 mm
- ▶ Extension bars 125 + 250 mm

14	○	10 - 11 - 12 - 13 - 14 - 15 - 17 - 18 - 19 - 22 - 24 - 27 - 30 - 32 mm	
2	○	16 + 21 mm	
1		Art. 39012900	
2		Verlängerungen 125 + 250 mm	
1		1/2" (Knarre) x 1/2" (Nuss)	



Größe/Size 1/2"
tlg./pcs. 20
BxLxH/WxLxH 360x260x75 mm
Gewicht/Weight 3.500 g

Art.-Nr./Art.-No. 3901203 1/2" Industrie-Steckschlüsselkoffer €

1/2" Steckschlüsselkoffer, 28-teilig, US-Zoll

1/2" Socket Set, 28 pieces, Inch



Art.-Gruppe 110
Article Group 110

4028

1/2"

28
tlg./pcs.



Industrie-Steckschlüssel Satz mit 28 Werkzeugen, Zoll, im Metallkoffer

- ▶ Industrieknarre
- ▶ Stecknüsse 7/16" – 1 1/4"
- ▶ Tiefe Stecknüsse von 15/16" – 1/2"

Industrial socket set with 28 assorted tools, inch, in metal case

- ▶ Industrial ratchet
- ▶ Sockets 7/16" – 1 1/4"
- ▶ Deep sockets 15/16" – 1/2"

13	○	7/16" - 1/2" - 9/16" - 5/8" - 11/16" - 3/4" - 13/16" - 7/8" - 15/16" - 1" - 1 1/16" - 1 1/8" - 1 1/4"	
8	○	15/16" - 7/8" - 13/16" - 3/4" - 11/16" - 5/8" - 9/16" - 1/2"	
2		5/8" + 13/16"	
2		Verlängerungen 5" + 10"	
1		1/2" (Knarre) x 1/2" (Nuss)	
1		Kardangelenk	
1		Art. 4228	

Größe/Size 1/2"
tlg./pcs. 28
BxLxH/WxLxH 450x275x55 mm
Gewicht/Weight 6.540 g

Art.-Nr./Art.-No. 4028 1/2" Steckschlüsselkoffer US-Zoll €

1/2" Industrie-Steckschlüsselkoffer mit Gabelringschlüsseln, 45-teilig

1/2" Socket Set with Combination Wrenches, 45 pieces



Art-Gruppe 110
Article Group 110

3901204

1/2"

45
tlg./pcs.

NEU/NEW



Industrie-Steckschlüsselkoffer mit 45 Werkzeugen

- ▶ PROJAHN Umschaltknarre
- ▶ Stecknüsse 8 – 34 mm
- ▶ Zündkerzen Stecknüsse 16 + 21 mm
- ▶ Verlängerungen 125 + 250 mm
- ▶ Ringgabelschlüssel 6 – 22 mm

Industrial socket set with 45 assorted tools

- ▶ PROJAHN ratchet handle, reversible
- ▶ Sockets 8 – 34 mm
- ▶ Spark plug sockets 16 + 21 mm
- ▶ Extension bars 125 + 250 mm
- ▶ Combination wrenches 6 – 22 mm

23	8 - 9 - 10 - 11 - 12 - 13 - 14 - 15 - 16 - 17 - 18 - 19 - 20 - 21 - 22 - 23 - 24 - 26 - 27 - 28 - 30 - 32 - 34 mm		2	Verlängerungen 125 + 250 mm	
2	16 + 21 mm		1	1/2" (Knarre) x 1/2" (Nuss)	
1	Art. 39012900		1	Kardangelen	
			15	6 - 7 - 8 - 9 - 10 - 11 - 12 - 13 - 14 - 15 - 16 - 17 - 18 - 19 - 22 mm	



Größe/Size 1/2"
tlg./pcs. 45
BxLxH/WxLxH 400x290x100 mm
Gewicht/Weight 6.700 g

Art.-Nr./Art.-No.		€
3901204	1/2" Industrie-Steckschlüsselkoffer	

3/4" Industrie-Steckschlüsselkoffer, 21-teilig

3/4" Socket Set, 21 pieces



Art-Gruppe 110
Article Group 110

3903401

3/4"

21
tlg./pcs.

NEU/NEW



Industrie-Steckschlüsselkoffer mit 21 Werkzeugen, metrisch

- ▶ Umschaltknarre
- ▶ Stecknüsse 19 – 50 mm
- ▶ Schiebegriff mit Gleitstück
- ▶ Verlängerungen 100 + 200 + 400 mm

Socket set with 21 assorted tools, metric

- ▶ Ratchet
- ▶ Sockets 19 – 50 mm
- ▶ 1 sliding t-handle
- ▶ 3 extension bars

16	○ 19 - 21 - 22 - 23 - 24 - 26 - 27 - 29 - 30 - 32 - 35 - 36 - 38 - 41 - 46 - 50 mm	
3	Verlängerungen 100, 200 + 400 mm	
1	Gleitgriff	
1	Art. 400001	

Größe/Size: 3/4" · **tlg./pcs.** 21 · **BxLxH/WxLxH:** 550x380x115 mm
Gewicht/Weight: 15.000 g

Art.-Nr./Art.-No.	€
3903401	3/4" Industrie-Steckschlüsselkoffer



Weitere PROForm-Werkstatteinlagen ab Seite /
More PROForm Inlays for Roller Cabinet from Page H 36

1" Industrie-Steckschlüsselkoffer, 22-teilig

1" Socket Set, 22 pieces

PROJAHN
PROFESSIONAL

Art-Gruppe 110
Article Group 110

2052

1"

22
tig./pcs.



Industrie-Steckschlüsselkoffer mit 22 Werkzeugen, metrisch

- ▶ Umschaltknarre
- ▶ Stecknüsse 36 – 80 mm
- ▶ Schiebegriff mit Gleitstück
- ▶ Verlängerungen 200 + 400 mm

Socket set with 22 assorted tools, metric

- ▶ Ratchet
- ▶ Sockets 36 – 80 mm
- ▶ 1 sliding t-handle
- ▶ 2 extension bars

17	36 - 38 - 41 - 46 - 50 - 54 - 55 - 58 - 60 - 63 - 65 - 67 - 70 - 71 - 75 - 77 - 80 mm	
2	Verlängerungen 200 + 400 mm	
1	Gleitgelenk	
1	Griff für Gleitgelenk 560 mm	
1	Art. 500000	

Größe/Size: 1" · **tlg./pcs.** 22 · **BxLxH/WxLxH:** 730x320x150 mm
Gewicht/Weight: 40.340 g

Art.-Nr./Art.-No. €
 2052 1" Industrie-Steckschlüsselkoffer

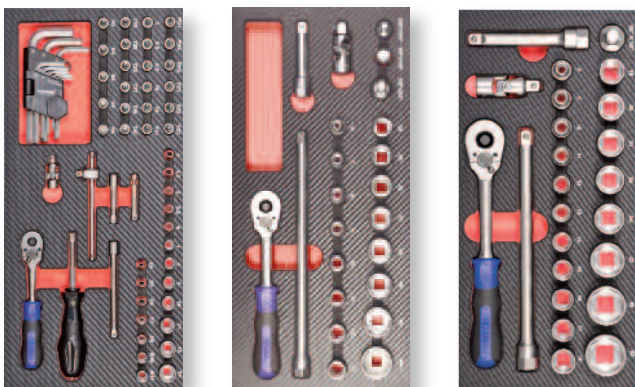

Weitere PROForm-Werkstatteinlagen ab Seite /
 More PROForm Inlays for Roller Cabinet from Page H 36

3/8" Universal Industrie-Werkzeugkoffer, 84-teilig

3/8" Universal Industrial Tool Set, 84 pieces



Art-Gruppe 110
Article Group 110

3903803

3/8"

84
tlg./pcs.

NEU/NEW



Universal Industrie-Werkzeugkoffer mit 84 Werkzeugen, metrisch

- ▶ PROJAHN Umschaltknarre
- ▶ Stecknüsse 8 – 22 mm
- ▶ Ringgabelschlüssel 8 – 21 mm
- ▶ 31-teilige Bit-Box 1/4"
- ▶ Magnetische Kugelpf-Stiftschlüssel-Set 9-teilig

Universal industrial tool set with 84 assorted tools, metric

- ▶ PROJAHN ratchet handle, reversible
- ▶ Sockets 8 – 22 mm
- ▶ Combination wrenches 8 – 21 mm
- ▶ 31 pcs bit box 1/4"
- ▶ Magnetic ball end hex key set 9pcs

13	8 - 10 - 11 - 12 - 13 - 14 - 15 - 16 - 17 - 18 - 19 - 21 - 22 mm	3/8"		1	Wasserpumpenzange 250 mm	
2	16 + 21 mm			1	Kombizange 180 mm	
1	Kardangelnk			1	Seitenschneider 160 mm	
1	Verlängerung 150 mm			1	Universalmesser	
1	3/8" (Knarre) x 1/4" (Bit)			1	Metallsägebogen 300 mm	
1	Art. 39038900			1	Hammer 300 g	
3	4 - 5.5 - 6.5 mm	1/4"		1	1.0 x 5.5 x 100 mm	
5	PH1 - PH1 - PH2 - PH2 - PH3			1	1.6 x 8.0 x 150 mm	
5	PZ1 - PZ1 - PZ2 - PZ2 - PZ3			2	PH 1 / PH 2	
9	T8 - 9 - 10 - 15 - 20 - 25 - 27 - 30 - 40			1	PZ 2	
8	2 - 2,5 - 3 - 4 - 5 - 6 - 7 - 8 mm			1	110 bis / up to 250 V Spannungsprüfer	
1	Magn. Bit-Halter 60 mm			1	Teleskop-Magnetheber	
1	Magn. Bit-Schraubendreher			1	Rollmeter 3 m	
9	1.5 - 2 - 2.5 - 3 - 4 - 5 - 6 - 8 - 10 mm			10	8 - 9 - 10 - 11 - 12 - 13 - 14 - 17 - 19 - 21 mm	



Größe/Size 1/4" + 3/8"
tlg./pcs. 84
BxLxH/WxLxH 550x380x115 mm
Gewicht/Weight 7.800 g

Art.-Nr./Art.-No.	€
3903803 3/8"	
Universal Werkzeugkoffer	

1/4" + 1/2" Industrie-Steckschlüsselkoffer, 91-teilig

1/4" + 1/2" Socket Set, 91 pieces



Art.-Gruppe 110
Article Group 110

3904201

1/4"

1/2"

NEU/NEW



91
tlg./pcs.

Industrie-Steckschlüsselkoffer mit 91 Werkzeugen, metrisch

- ▶ 2 PROJAHN Umschaltknarren 1/4" + 1/2"
- ▶ Stecknüsse 3,5 – 32 mm ▶ Kardangelenke
- ▶ Tiefe Stecknüsse 6 – 19 mm
- ▶ Zündkerzen Stecknüsse 16 + 21 mm
- ▶ 1/4" Bit Stecknüsse für alle Schraubarbeiten
- ▶ Industrie-Bits 5/16" und 1/2" Adapter für alle Schraubarbeiten
- ▶ Verlängerungen 50 + 100 + 125 + 250 mm
- ▶ Kardangelenke

Industrial socket set with 91 assorted tools, metric

- ▶ 2 PROJAHN ratchet handles, reversible 1/4"+1/2"
- ▶ Sockets 3,5 – 32 mm ▶ Universal joints
- ▶ Deep sockets 6 – 19 mm
- ▶ Spark plug sockets 16 + 21 mm
- ▶ Bit sockets 1/4" for all screws
- ▶ Industrial bits 5/16" and 1/2" adapter for all screws
- ▶ Extension bars 50 + 100 + 125 + 250 mm
- ▶ Universal joints

14	○ 3.5 - 4 - 4.5 - 5 - 5.5 - 6 - 7 - 8 - 9 - 10 - 11 - 12 - 13 - 14 mm	1/4"	
8	○ 6 - 7 - 8 - 9 - 10 - 11 - 12 - 13 mm		
3	● 4 - 5.5 - 6.5 mm		
3	⊕ PH 1 - 2 - 3		
3	⊕ PZ 1 - 2 - 3		
4	● 3 - 4 - 5 - 6 mm		
8	⊗ T8 - 9 - 10 - 15 - 20 - 25 - 27 - 30		
1	Kardangelenke		
2	Verlängerungen 50 + 100 mm		
1	Gleitgriff		
1	Steckgriff		
1	Art. 39014900		

14	○ 10 - 13 - 15 - 16 - 17 - 18 - 19 - 20 - 21 - 22 - 24 - 27 - 30 - 32 mm	1/2"	
4	○ 14 - 15 - 17 - 19 mm		
3	⊕ T50 - 55 - 60		
2	○ 16 + 21 mm		
1	1/2" (Knarre) x 1/2" (Nuss)		
2	Verlängerungen 125 + 250 mm		
1	1/2" (Knarre) x 5/16" (Bit)		
1	Kardangelenke		
1	Art. 39012900		
4	● 6.5 - 8 - 10 - 12 mm	5/16"	
3	⊕ PH 2 - 3 - 4		
3	⊕ PZ 2 - 3 - 4		
3	⊗ T30 - 40 - 45		



Größe/Size 1/4"+ 1/2"+ 5/16"
 tlg./pcs. 91
 BxLxH/WxLxH 400x290x100 mm
 Gewicht/Weight 6.700 g

Art.-Nr./Art.-No.	€
3904201	1/4" + 1/2"
Industrie-Steckschlüsselkoffer	

1/2" Universal Industrie-Werkzeugkoffer, 67-teilig

1/2" Universal Industrial Tool Set, 67 pieces

3901205

1/2"

NEU/NEW



Universal Industrie-Werkzeugkoffer mit 67 Werkzeugen, metrisch

- ▶ PROJAHN Umschaltknarre
- ▶ Stecknüsse 8 – 27 mm
- ▶ Zündkerzen-Stecknüsse 16 + 21 mm
- ▶ 31-teilige Bit-Box 1/4"
- ▶ Doppelgabelschlüssel, metrisch 6 – 22 mm
- ▶ Schlosserhammer 300 g
- ▶ Zangen mit 2-Komponenten-Griff
- ▶ Schraubendreher mit 2-Komponenten-Griff

Universal industrial tool set with 67 assorted tools, metric

- ▶ PROJAHN ratchet handles, reversible
- ▶ Sockets 8 – 27 mm
- ▶ Spark plug sockets 16 + 21 mm
- ▶ 31 pcs bit box 1/4"
- ▶ Double open end wrenches 6 – 22 mm
- ▶ Hammer 300 g
- ▶ Pliers with 2k-handle
- ▶ Screwdrivers with 2k-handle

3	4 - 5.5 - 6.5 mm	1/4"		2	5.5 x 1.0 - 8 x 1.6 mm	
5	PH1 - PH1 - PH2 - PH2 - PH3			1	PH 2	
5	PZ1 - PZ1 - PZ2 - PZ2 - PZ3			1	Magn. Bit-Schraubendreher	
9	T8 - 9 - 10 - 15 - 20 - 25 - 27 - 30 - 40			1	110 bis/up to 250 V Spannungsprüfer	
8	2 - 2.5 - 3 - 4 - 5 - 6 - 7 - 8 mm			1	1.2 x 6.5 x 38 mm	
1	Magn. Bit-Halter 60 mm			1	PH 2	
11	8 - 10 - 12 - 13 - 14 - 15 - 17 - 19 - 22 - 24 - 27 mm	1/2"		1	Wasserpumpenzange 250 mm	
2	16 + 21 mm			1	Kombizange 180 mm	
2	Verlängerungen 125 + 250 mm			1	Hammer 300 g	
1	Kardangeln			8	6 x 7 - 8 x 9 - 10 x 11 - 12 x 13 - 14 x 15 - 16 x 17 - 18 x 19 - 20 x 22 mm	
1	1/2" (Knarre) x 1/2" (Nuss)					
1	Art. 39012900					



Größe/Size 1/4" + 1/2"
 tlg./pcs. 67
 BxLxH/WxLxH 460x350x90 mm
 Gewicht/Weight 6.900 g

Art.-Nr./Art.-No.	€
3901205	1/2"
Universal Werkzeugkoffer	

1/4" + 3/8" + 1/2" Universal Industrie-Steckschlüsselkoffer, 122-teilig

1/4" + 3/8" + 1/2" Universal Industrie Socket Set, 122 pieces



Art.-Gruppe 110
Article Group 110

39048201

1/4"

3/8"

1/2"

122
tlg./pcs.

NEU/NEW



Universal Industrie-Steckschlüsselkoffer mit 122 Werkzeugen, metrisch

- ▶ 3 PROJAHN Umschaltknarren 1/4" + 3/8" + 1/2"
- ▶ Stecknüsse 4 – 32 mm
- ▶ Verlängerungen 50 + 75 + 100 + 125 + 150 + 250 mm
- ▶ Kugelpf Stiftschlüssel Satz 9-teilig, magnetisch
- ▶ Ringgabelschlüssel 6 – 22 mm
- ▶ 31-teilige BitBox 1/4"
- ▶ Kombizange, Seitenschneider, Wasserpumpenzange
- ▶ Sechs Schraubendreher + ein Spannungsprüfer

Universal industrial socket set with 122 assorted tools, metric

- ▶ PROJAHN ratchet handles, reversible 1/4" + 3/8" + 1/2"
- ▶ Sockets 4 – 32 mm
- ▶ Extension bars 50 + 75 + 100 + 125 + 150 + 250 mm
- ▶ Magnetic ball end hex key set 9pcs
- ▶ Combination wrenches 6 – 22 mm
- ▶ 31 pcs bit box 1/4"
- ▶ Pliers ▶ 6 screwdrivers and a voltage tester

12	○ 4 - 4.5 - 5 - 5.5 - 6 - 7 - 8 - 9 - 10 - 11 - 12 - 13 mm	1/4"		2	1/2" (Knarre) x 1/2" (Nuss) 1/2" (Knarre) x 3/8" (Nuss)	1/2"	
1	1/4" x 1/4"			1	Kardangeln		
1	Magn. Bit-Halter 60 mm			13	○ 17 - 18 - 19 - 20 - 21 - 22 - 23 - 24 - 26 - 27 - 28 - 30 - 32 mm		
3	● 4 - 5.5 - 6.5 mm			2	Verlängerungen 125 + 250 mm		
8	● 2 - 2.5 - 3 - 4 - 5 - 6 - 7 - 8 mm			1	Art. 39012900		
9	⊗ T8 - 9 - 10 - 15 - 20 - 25 - 27 - 30 - 40			1	Wasserpumpenzange 250 mm		
5	⊕ PH 1 - PH 1 - PH 2 - PH 2 - PH 3			1	Kombizange 180 mm		
5	⊕ PZ 1 - PZ 1 - PZ 2 - PZ 2 - PZ 3			1	Seitenschneider 160 mm		
1	Kardangeln			1	● 1.0 x 5.5 x 125 mm		
2	Verlängerungen 50 + 100 mm			1	● 1.6 x 8.0 x 150 mm		
1	Magn. Bit-Schraubendreher			2	⊕ PH1/PH2		
1	Gleitgriff			2	⊕ PZ1/PZ2		
1	Art. 39014900			1	110 bis/up to 250 V Spannungsprüfer		
1	Bit-Knarre, Art. 2700			9	1.5 - 2 - 2.5 - 3 - 4 - 5 - 6 - 8 - 10 mm		
1	1/4" x 1/4"			16	6 - 7 - 8 - 9 - 10 - 11 - 12 - 13 - 14 - 15 - 16 - 17 - 18 - 19 - 21 - 22 mm		
1	Steckgriff						
10	○ 10 - 11 - 12 - 13 - 14 - 15 - 16 - 17 - 18 - 19 mm	3/8"					
2	Verlängerungen 75 + 150 mm						
1	3/8" (Knarre) x 1/4" (Bit)						
1	Kardangeln						
1	Art. 39038900						



Größe/Size 1/4" + 3/8" + 1/2"
 tlg./pcs. 122
 BxLxH/WxLxH 550x380x115 mm
 Gewicht/Weight 10.500 g

Art.-Nr./Art.-No.	€
39048201	1/4" + 3/8" + 1/2"
Industrie-Steckschlüsselkoffer	

1/4" + 3/8" + 1/2" Industrie-Steckschlüsselkoffer, 195-teilig

1/4" + 3/8" + 1/2" Socket Set, 195 pieces



Art.-Gruppe 110
Article Group 110

39048202

1/4"

3/8"

1/2"

195
tlg./pcs.

NEU/NEW



Industrie-Steckschlüsselkoffer mit 195 Werkzeugen, metrisch

- ▶ 3 PROJAHN Umschaltknarren 1/4" + 3/8" + 1/2"
- ▶ Stecknüsse 4 – 32 mm ▶ Tiefe Stecknüsse 6 – 22 mm
- ▶ Verlängerungen 50 + 75 + 100 + 125 + 150 + 250 mm
- ▶ Innen-TX-Stecknüsse E4 – E20
- ▶ Kugelkopf Stiftschlüssel Satz 9-teilig, magnetisch
- ▶ Ringgabelschlüssel 6 – 22 mm
- ▶ Bit-Stecknüsse für alle Schraubarbeiten
- ▶ Tiefe Schlagnüsse 16 – 22 mm

Industrial socket set with 195 assorted tools, metric

- ▶ PROJAHN ratchet handles, reversible 1/4" + 3/8" + 1/2"
- ▶ Sockets 4 – 32 mm ▶ Deep sockets 6 – 22 mm
- ▶ Extension bars 50 + 75 + 100 + 125 + 150 + 250 mm
- ▶ TX-sockets E4 – E20 ▶ Combination wrenches 6 – 22 mm
- ▶ Ball end hex key set 9pcs, magnetic ▶ Bit-sockets for all screws
- ▶ Deep impact sockets 16 – 22 mm

- | | | | | |
|----|---|--|------|--|
| 12 | ○ | 4 - 4.5 - 5 - 5.5 - 6 - 7 - 8 - 9 - 10 - 11 - 12 - 13 mm | 1/4" | |
| 4 | ○ | 6 - 7 - 8 - 9 mm | | |
| 3 | ● | 4 - 5.5 - 6.5 mm | | |
| 2 | + | PH 1 - 2 | | |
| 2 | + | PZ 1 - 2 | | |
| 4 | ● | 3 - 4 - 5 - 6 mm | | |
| 8 | ● | T8 - 9 - 10 - 15 - 20 - 25 - 27 - 30 | | |
| 1 | | 1/4" x 1/4" | | |
| 1 | | Bit-Halter 60 mm | | |
| 4 | ● | 3 - 4 - 5 - 6 mm | | |
| 7 | ⊕ | T10 - 15 - 20 - 25 - 27 - 30 - 40 | | |
| 3 | + | PH 1 - 2 - 3 | | |
| 3 | + | PZ 1 - 2 - 3 | | |
| 1 | | Kardangelenk | | |
| 2 | | Verlängerungen 50 + 100 mm | | |
| 1 | | Magn. Bit-Schraubendreher | | |
| 1 | | Steckgriff | | |
| 1 | | Art. 39014900 | | |
| 1 | | Bit-Knarre, Art. 2700 | | |
| 1 | | Gleitgriff | | |

- | | | | | |
|----|---|--|------|--|
| 10 | ○ | 10 - 11 - 12 - 13 - 14 - 15 - 16 - 17 - 18 - 19 mm | 3/8" | |
| 6 | ○ | 10 - 11 - 12 - 13 - 14 - 15 mm | | |
| 2 | ○ | 16 + 21 mm | | |
| 2 | | Kippverlängerung 75 und 150 mm | | |

- | | | | | |
|----|---|---|--|--|
| 12 | ⊕ | E4 - 5 - 6 - 7 - 8 - 10 - 11 - 12 - 14 - 16 - 18 - 20 | | |
| 1 | | 1/2" (Knarre) x 3/8" (Nuss) | | |
| 1 | | 3/8" (Knarre) x 1/4" (Bit) | | |
| 1 | | Kardangelenk | | |
| 1 | | Art. 39038900 | | |

- | | | | | |
|----|---|---|------|--|
| 1 | | 1/2" (Knarre) x 5/16" (Bit) | 1/2" | |
| 1 | | 1/2" (Knarre) x 1/2" (Nuss) | | |
| 1 | | Kardangelenk | | |
| 2 | | Kippverlängerung 125 + 250 mm | | |
| 13 | ○ | 17 - 18 - 19 - 20 - 21 - 22 - 23 - 24 - 26 - 27 - 28 - 30 - 32 mm | | |
| 4 | ○ | 17 - 18 - 19 - 22 mm | | |
| 6 | | Tiefe Schlag-Stecknuss 16 - 17 - 18 - 19 - 21 - 22 mm | | |
| 2 | | Sicherungsring und -stift für Schlagnüsse | | |
| 1 | | Art. 39012900 | | |

- | | | | | |
|----|---|--|-------|--|
| 3 | ● | 8 - 10 - 12 mm | 5/16" | |
| 4 | ● | 4 - 5 - 6 - 8 mm | | |
| 4 | + | PH 1 - 2 - 3 - 4 mm | | |
| 4 | + | PZ 1 - 2 - 3 - 4 mm | | |
| 4 | ● | M6 - 8 - 10 - 12 | | |
| 5 | ● | T25 - 30 - 40 - 45 - 50 | | |
| 9 | ⊕ | T10 - 15 - 20 - 25 - 27 - 30 - 40 - 45 - 50 | | |
| 8 | ⊕ | T15 - 20 - 25 - 27 - 30 - 40 - 45 - 50 | | |
| 9 | | 1.5 - 2 - 2.5 - 3 - 4 - 5 - 6 - 8 - 10 mm | | |
| 16 | | 6 - 7 - 8 - 9 - 10 - 11 - 12 - 13 - 14 - 15 - 16 - 17 - 18 - 19 - 21 - 22 mm | | |



Größe/Size: 1/4" + 3/8" + 1/2" · tlg./pcs. 195
BxLxH/WxLxH: 550x380x115 mm · Gewicht/Weight: 13.500 g

Art.-Nr./Art.-No. 39048202 €

1/4" Xi-on Steckschlüssel-Satz, 18-teilig*1/4" Xi-on Socket Set, 18 pieces***Art.-Gruppe 110**
Article Group 110**4101****1/4"****18**
tlg./pcs.**3/8" Xi-on Steckschlüssel-Satz, 17-teilig***3/8" Xi-on Socket Set, 17 pieces***Art.-Gruppe 110**
Article Group 110**4111****3/8"****17**
tlg./pcs.**Xi-on Steckschlüssel-Satz mit 18 Werkzeugen, metrisch**

- ▶ Feinzahn-Umschaltknarre
- ▶ Xi-on Stecknüsse 4 – 13 mm
- ▶ Verlängerung 50 mm
- ▶ Kardangelen u.v.m.

Xi-on Socket Set with 18 assorted tools, metric

- ▶ Reversible Ratchet
- ▶ Xi-on sockets 4 – 13 mm
- ▶ Extension Bar 50 mm
- ▶ Universal Joint, etc.

Xi-on
MULTISTECKNUS**Xi-on Steckschlüssel-Satz mit 17 Werkzeugen, metrisch**

- ▶ Feinzahn-Umschaltknarre
- ▶ Xi-on Stecknüsse 8 – 19 mm
- ▶ Verlängerung 75 + 150 mm
- ▶ Kardangelen u.v.m.

Xi-on Socket Set with 17 assorted tools, metric

- ▶ Reversible Ratchet
- ▶ Xi-on sockets 8 – 19 mm
- ▶ Extension Bar 75 + 150 mm
- ▶ Universal Joint, etc.

Xi-on
MULTISTECKNUS

12	○	4 - 4,5 - 5 - 5,5 - 6 - 7 - 8 - 9 - 10 - 11 - 12 - 13 mm	1/4"	Xi-on	
1		Verlängerung, 50 mm			
1		Art. 5205, 1/4" 72 Zahn			
1		Kardangelen			
1		Gleitgriff			
1		Steckgriff			
1		Austreiber			

Größe/Size: 1/4" · **tlg./pcs.** 18 · **BxLxH/WxLxH** 225x125x45 mm
Gewicht/Weight: 1.020 g

11	○	8 - 10 - 11 - 12 - 13 - 14 - 15 - 16 - 17 - 18 - 19 mm	3/8"	Xi-on	
2		Verlängerungen, 75 + 150 mm			
1		Art. 5215, 3/8" 72 Zahn			
1		Kardangelen			
1		Gleitgriff			
1		Austreiber			

Größe/Size: 3/8" · **tlg./pcs.** 17 · **BxLxH/WxLxH:** 260x145x50 mm
Gewicht/Weight: 2.000 g

Art.-Nr./Art.-No. €

4101 1/4" Xi-on Steckschlüssel-Satz

Art.-Nr./Art.-No. €

4111 3/8" Xi-on Steckschlüssel-Satz

1/2" Xi-on Steckschlüssel-Satz, 23-teilig

1/2" Xi-on Socket Set, 23 pieces

Art.-Gruppe 110
Article Group 110

4121



Xi-on Steckschlüssel-Satz mit 23 Werkzeugen, metrisch

- ▶ Feinzahn-Umschaltknarre
- ▶ Xi-on Stecknüsse 10 – 32 mm
- ▶ Verlängerungen 125 + 250 mm
- ▶ Kardangelenk u.v.m.

Xi-on Socket Set with 23 assorted tools, metric

- ▶ Reversible Ratchet
- ▶ Xi-on sockets 10 – 32 mm
- ▶ Extension Bars 125 + 250 mm
- ▶ Universal Joint, etc.



15	○	10 - 11 - 12 - 13 - 14 - 15 - 16 - 17 - 18 - 19 - 22 - 24 - 27 - 30 - 32 mm		Xi-on	
2	○	16 + 21 mm			
2		Verlängerungen 125 + 250 mm			
1		Art. 5225, 1/2" 60 Zahn			
1		Kardangelenk			
1		Gleitgriffadapter			
1		Austreiber			

Größe/Size: 1/2" · **tlg./pcs.** 23 · **BxLxH/WxLxH:** 450x195x55 mm
Gewicht/Weight: 4.530 g

Art.-Nr./Art.-No.

4121	1/2" Xi-on Steckschlüssel-Satz
4131	1/4" + 1/2" Xi-on Steckschlüssel-Satz

€

1/4" + 1/2" Xi-on Steckschlüssel-Satz, 54-teilig

1/4" + 1/2" Xi-on Socket Set, 54 pieces

Art.-Gruppe 110
Article Group 110

4131



Xi-on Steckschlüssel-Satz mit 54 Werkzeugen, metrisch

- ▶ 2 Feinzahn-Umschaltknarren
- ▶ Xi-on Stecknüsse 4 – 32 mm
- ▶ Verlängerungen 50 + 125 + 150 + 250 mm
- ▶ Kardangelenke u.v.m.

Xi-on Socket Set with 54 assorted tools, metric

- ▶ 2 Reversible Ratchets
- ▶ Xi-on sockets 4 – 32 mm
- ▶ Extension Bars 50 + 125 + 150 + 250 mm
- ▶ Universal Joints, etc.



11	○	4 - 4,5 - 5 - 5,5 - 6 - 7 - 8 - 9 - 10 - 11 - 13 mm		Xi-on	
2		Verlängerungen 50 + 150 mm			
1		Art. 5205, 1/4" 72 Zahn			
1		Kardangelenk			
1		Gleitgriffadapter			
1		Steckgriff			
1		Austreiber			
2	●	5,5 - 7 mm			
2	+	PH 1 - 2			
6	●	3 - 4 - 5 - 6 - 8 - 10			

15	○	10 - 11 - 12 - 13 - 14 - 15 - 17 - 18 - 19 - 21 - 22 - 24 - 27 - 30 - 32 mm		Xi-on	
2	○	16 + 21 mm			
2		Verlängerungen 125 + 250 mm			
1		Art. 5225, 1/2" 60 Zahn			
1		Kardangelenk			
1		Gleitgriffadapter			
4		1,27 - 1,5 - 2 - 2,5 mm			

Größe/Size: 1/4" + 1/2" · **tlg./pcs.** 54 · **BxLxH/WxLxH:** 450x200x55 mm
Gewicht/Weight: 5.200 g

1/4" + 3/8" Durchschraubknarren Satz, 25-teilig*1/4" + 3/8" Go-Through Socket Set, 25 pieces*Art.-Gruppe 110
Article Group 110

4016

1/4"

3/8"

25
tlg./pcs.**Durchschraubknarren Satz mit 25 Werkzeugen, metrisch**

- ▶ 3/8" Durchgangsknarre
- ▶ 3/8" Durchgangsverlängerung 75 mm
- ▶ 3/8" Durchgangsnüsse 10 – 19 mm
- ▶ 1/4" Stecknüsse 4 – 14 mm
- ▶ 3/8" Nussadapter für 1/4" Nüsse

Go-Through socket set with 25 assorted tools, metric

- ▶ 3/8" go-through ratchet
- ▶ 3/8" go-through extension bar 75 mm
- ▶ 3/8" go-through sockets 10 – 19 mm
- ▶ 1/4" sockets 4 – 14 mm
- ▶ 3/8" adapter for 1/4" sockets

13 ○ 4 - 4,5 - 5 - 5,5 - 6 - 7 - 8 - 9 - 10 -
11 - 12 - 13 - 14 mm

1/4"



9 ○ 10 - 11 - 12 - 13 - 14 - 15 - 16 - 17 - 19 mm

3/8"



1 Art. 4016-01



1 Verlängerung 75 mm

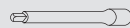

1 3/8" (Knarre) x 1/4" (Nuss)



Größe/Size 1/4" + 3/8"
tlg./pcs. 25
BxLxH/WxLxH 245x122x45 mm
Gewicht/Weight 1.200 g

Art.-Nr./Art.-No. €
 4016 1/4" + 3/8" Durchsteckknarren-Satz

GearTech Durchschraubknarren-Satz, 17-teilig*GearTech Go-Through Socket Set, 17 pieces*Art.-Gruppe 110
Article Group 110

4017

17
tlg./pcs.

NEU/NEW

- ▶ 3D-GearTech-FLEX-Knarre ermöglicht Arbeiten in drei Dimensionen
- ▶ Ideal für Arbeiten an extrem unzugänglichen Stellen
- ▶ Flexibel: Durchgangsnüsse für metrische und zöllige Schrauben sowie für Schrauben mit TORX®E-Profil

- ▶ 3D-GearTech-Flex ratchet allows working in 3 dimensions
- ▶ Easy to use for very narrow spaces
- ▶ Flexible to use: Go-Through Sockets fits with metric and inch screws and also with screws with TORX®E-profile



3D GearTech FLEX

13 ○ 10 - 11 - 12 - 13 - 14 - 15 - 16 - 17 -
18 - 19 - 21 - 22 - 24 mm

1 3D-GearTech-Flex Art. 4017-01

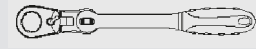

1 Verlängerung 80 mm



1 Adapter 1/4"



1 Adapter 3/8"



Tlg./pcs. 17 · **BxLxH/WxLxH:** 300x175x65 mm
Gewicht/Weight: 1.760 g

Art.-Nr./Art.-No. €
 4017 GearTech Durchschraubknarren-Satz

1/4" Mini-Steckschlüssel- und Bit-Box, 38-teilig

1/4" Mini Socket Set and Bit Box, 38 pieces

Art.-Gruppe 110
Article Group 110

394072

1/4"

38
tlg./pcs.

NEU/NEW



- ▶ **Kombination aus Steckschlüsselsatz und Bit-Box**
 - ▶ **Schnell das passende Werkzeug für nahezu jede Anwendung**
 - ▶ **Übersichtliche Anordnung der Werkzeuge**
 - ▶ **Color-Bits: Dank Farbleitsystem immer schnell den richtigen Bit**
- ▶ Combination of Socket-Set and Bit-Box
 - ▶ Easy and fast accessibility of the tools
 - ▶ Clearly assembled tools
 - ▶ Color-Bits: very easy to find the right size, because of colored bits

- 10 Stecknüsse 5,5 - 6 - 7 - 8 - 9 - 10 - 11 - 12 - 13 - 14 mm
- 2 Verlängerungen 50 + 100 mm
- 1 Umschaltknarre 48-ZAHN
- 1 Kardangelenk
- 1 Steckgriff
- 1 Adapter 1/4" (Knarre) x 1/4" (Bit)
- 2 Schlitz (rot) 4,5 - 6,5 mm
- 4 Phillips (dunkelrot) PH1 - 2 - 2 - 3
- 4 Pozidriv (blau) PZ1 - 2 - 2 - 3
- 7 TORX® m. Bohr. (violett) TX10 - 15 - 20 - 25 - 27 - 30 - 40
- 4 Inbus (orange) 3 - 4 - 5 - 6 mm
- 1 Adapter 1/4" x 1/4"

Größe/Size: 1/4" · tlg./pcs. 38 · BxLxH/WxLxH: 188x110x40 mm
Gewicht/Weigh: 900 g

Art.-Nr./Art.-No.	€
8601	1/4" MutliFit Steckschlüsselsatz
394072	1/4" Mini-Steckschlüssel- und Bit-Box

1/4" MultiFit Steckschlüsselsatz, 28-teilig

1/4" MultiFit Socket Set, 28 pieces

Art.-Gruppe 112
Article Group 112

8601

1/4"

28
tlg./pcs.



mit Feinzahn-Knarre, 72 Zahn

72 Teeth Ratchet

- ▶ **1 Schlüssel – 4 Schrauben**
MultiFit-Profil – Mit einem Steckschlüssel-Einsatz bis zu vier verschiedene Schrauben oder Muttern bearbeiten!
1 Socket – 4 Drives: With MultiFit profile you can even use only 1 socket for 4 kinds of drives!
- ▶ **6-kant, 12-kant, TORX® E-Profil und viele andere Zollgrößen**

MultiFit	6-kant	12-kant	Zoll	E-TX
4,0 mm	✓	✓	5/32"	E5
4,5 mm	✓	✓		E6
5,0 mm	✓	✓	3/16"	
5,5 mm	✓	✓		
6,0 mm	✓	✓		E8
7,0 mm	✓	✓	9/32"	
8,0 mm	✓	✓	5/16"	E10
9,0 mm	✓	✓	11/32"	
10,0 mm	✓	✓	3/8"	E12
11,0 mm	✓	✓	7/16"	E14
12,0 mm	✓	✓	15/32"	E16
13,0 mm	✓	✓	1/2"	
14,0 mm	✓	✓	9/16"	E18

- 13 4 - 4.5 - 5 - 5.5 - 6 - 7 - 8 - 9 - 10 - 11 - 12 - 13 - 14 mm
- 3 4 - 5 - 6 mm
- 3 PH 1 - 2 - 3
- 3 PZ 1 - 2 - 3
- 3 4 - 5 - 6 mm
- 1 1/4" Bit-Adapter
- 1 **72 Zahn, Art. 8603**
- 1 Verlängerung 50 mm

Größe/Size: 1/4" · tlg./pcs. 28 · BxLxH/WxLxH: 166x85x35 mm
Gewicht/Weight: 660 g

1/4" Steckschlüsselbox, 15-teilig*1/4" Socket Set, 15 pieces***Art.-Gruppe 110**
Article Group 110**4009****1/4"****15**
tlg./pcs.

Größe/Size: 1/4" **tlg./pcs.** 15 **BxLxH/WxLxH:** 245x128x40 mm
Gewicht/Weight: 1.260 g

**Steckschlüsselbox mit 15 Werkzeugen
inkl. Fingerratsche***Socket set with 15 assorted tools with finger-ratchet*

12  4 - 4,5 - 5 - 5,5 - 6 - 7 - 8 - 9 -
10 - 11 - 12 - 13 mm



1 Verlängerung 195, 220, 245, 270, 295 oder 320 mm

1 Fingerratsche mit Auswurf, Art. 4283
quick release finger ratchet



1 T-Griff-Ratsche mit Auswurf, Art. 4284
T-handle quick release ratchet

**Art.-Nr./Art.-No.**

€

4009

1/4" Steckschlüsselbox

1/2" Kraftknarren-Steckschlüsselkoffer, 17-teilig

1/2" Power Ratchet Socket Set, 17 pieces

394020

1/2"

17
tlg./pcs.

NEU/NEW



Größe/Size	1/2"
tlg./pcs.	17
BxLxH/WxLxH	480x260x90 mm
Gewicht/Weight	5.500 g

Art.-Nr./Art.-No.	€
394020	1/2" Kraftknarren-Steckschlüsselkoffer

Kraftknarren-Steckschlüssel-Koffer mit 17 Werkzeugen, metrisch

- ▶ Kraft-Knarre belastbar bis 720 Nm, 360° drehbarer Knarrenkopf
- ▶ Knarre und Hebel auf bis zu 800 mm verlängerbar, schwenkbar und aus Spezialstahl
- ▶ Kraft-Hebel löst extrem festsitzende Schrauben und Muttern, rutschfeste und stabile Handgriffe
- ▶ Flexibel einsetzbar, extrem robust, ideal auch bei sehr wenig Platz
- ▶ Ergonomisches Design, kompakter, bruchsicherer Koffer

Power Ratchet Socket Set with 17 tools, metric

- ▶ Power-ratchet resistant till 720 Nm, 360° turnable ratchet head
- ▶ Ratchet and release lever till 800 mm prolongable, pivoting power-lever made of special steel
- ▶ Power hand gear to loosen very hard fixed screws and nuts, non-slip and robust handles
- ▶ Flexible to use and extremely sturdy, ideal use for very narrow spaces
- ▶ Ergonomic design, compact, shatterproof case

8	○	17 - 19 - 21 - 22 - 24 - 27 - 30 - 32 mm	
1		48 Zahn / 48 teeth Kraft-Knarre mit 360° drehbarem Kopf	
1		Krafthebel schwenkbar	
2		Handgriffe 155 + 280 mm	
1		Handgriff-Verlängerung 300 mm	
2		Verlängerungen 125 + 250 mm	
1		Adapter	
1		Adapter 1/2" auf 3/4"	

1/2" Spiralprofil-Steckschlüssel-Satz, 10-teilig

1/2" Twist Socket Set, 10 pieces

3061

1/2"

10
tlg./pcs.

Ideal für problemloses Ausdrehen von abgerundeten Muttern und 6-kant Schrauben durch ein sich verjüngendes Spezialprofil mit aggressiven Spiralnuten.

Special Sockets for opening damaged nuts.

Art.-Nr./Art.-No.	Größe/Size	€
3061	1/2" Spiralprofil-Steckschlüssel-Satz	

1/4" Mini-Steckschlüsselkoffer 23-teilig

1/4" Mini Socket Set, 23 pieces

Art-Gruppe 110
Article Group 110

4078

1/4"

23
tlg./pcs.



Mini-Steckschlüsselkoffer mit 23 Werkzeugen, metrisch

- ▶ **Miniknarre**
- ▶ **Stecknüsse 4 – 13 mm**
- ▶ **Bits für jeden Einsatz**
- ▶ **Verlängerung**
- ▶ **Bit-Adapter**

Mini socket set with 23 assorted tools, metric

- ▶ **Mini ratchet**
- ▶ **Sockets 4 – 13 mm**
- ▶ **Bits for all screws**
- ▶ **Extension bar**
- ▶ **Bit adapter**

12	○	4 - 4.5 - 5 - 5.5 - 6 - 7 - 8 - 9 - 10 - 11 - 12 - 13 mm	
2	+	PH 1 - 2	
2	+	PZ 1 - 2	
4	⊙	T15 - 20 - 25 - 30	
1		1/4" Bit-Adapter	
1		Art. 4299	
1		Verlängerung 100 mm	



Größe/Size 1/4"
tlg./pcs. 23
BxLxH/WxLxH 160x83x33 mm
Gewicht/Weight 450 g

Art.-Nr./Art.-No.	€
4078	1/4" Mini-Steckschlüsselkoffer
8651	1/4" Steckschlüsselkoffer 48 Z
8652	1/4" Steckschlüsselkoffer 72 Z

1/4" Steckschlüsselkoffer, 46-teilig

1/4" Socket Set, 45 pieces



Art-Gruppe 112
Article Group 112

1/4"

45
tlg./pcs.

8651
48-Zahn-
Knarre

8652
72-Zahn-
Knarre



Steckschlüsselkoffer mit 45 Werkzeugen, metrisch

- ▶ **Mit Umschaltknarre 48 Zahn (Art.-Nr. 8651) oder mit Umschaltknarre 72 Zahn (Art.-Nr. 8652)**
- ▶ **Stecknüsse 4 – 14 mm**

Socket set with 45 assorted tools, metric

- ▶ **With ratchet, 48 teeth (Art.-Nr. 8651) or with ratchet, 72 teeth (Art.-Nr. 8652)**
- ▶ **Sockets 4 – 14 mm**

13	○	4 - 4.5 - 5 - 5.5 - 6 - 7 - 8 - 9 - 10 - 11 - 12 - 13 - 14 mm	
3	●	4 - 5.5 - 7 mm	
3	+	PH 1 - 2 - 3	
3	+	PZ 1 - 2 - 3	
6	⊙	3 - 4 - 5 - 6 - 7 - 8 mm	
6	⊙	T8 - 10 - 15 - 20 - 25 - 30 - 40	
1		48 Zahn, Art. 5200 oder/ or 72 Zahn, Art. 5201	
1		Steckgriff	
2		Verlängerung 50 + 100 mm	
1		Gleitgriff	
1		Kardangelen	
1		Verlängerung flex. 150 mm	
1		1/4" x 1/4"	
3		1,5 - 2 - 2,5 mm	

Größe/Size: 1/4" · **tlg./pcs.** 46 · **BxLxH/WxLxH:** 245x180x60 mm
Gewicht/Weight: 1.250 g

1/2" Steckschlüssel-Koffer, 21-tlg.

1/2" Socket Set, 21 pieces



Art.-Gruppe 112
Article Group 112

1/2"

21
tlg./pcs.

NEU/NEW

8661
48-Zahn-
Knarre

8662
72-Zahn-
Knarre



Steckschlüssel-Koffer mit 21 Werkzeugen, metrisch

- ▶ Mit Umschaltknarre 48 Zahn (Art.-Nr. 8661) oder mit Umschaltknarre 72 Zahn (Art.-Nr. 8662)
- ▶ Inkl. Zündkerzen-Stecknüsse 16 + 21 mm

Socket set with 21 assorted tools, metric

- ▶ With ratchet, 48 teeth (Art.-Nr. 8661) or with ratchet, 72 teeth (Art.-Nr. 8662)
- ▶ Incl. spark plug sockets 16 + 21 mm

- 15 10 - 11 - 12 - 13 - 14 - 15 - 16 - 17 - 18 - 19 - 22 - 24 - 27 - 30 - 32 mm
- 2 16 + 21 mm
- 1 **48 ZAHN**, Art. 5220 oder/or **72 ZAHN**, Art. 5221
- 1 Verlängerung 125 mm
- 1 Gleitgriff
- 1 Kardangelenk

Größe/Size: 1/2" · tlg./pcs. 21 · **BxLxH/WxLxH:** 300x230x70 mm
Gewicht/Weight: 3.500 g

Art.-Nr./Art.-No.	€
8661	1/2" proficraft Steckschlüssel-Koffer 48 Z
8662	1/2" proficraft Steckschlüssel-Koffer 72 Z

1/2" Steckschlüsselkoffer, 22-teilig

1/2" Socket Set, 22 pieces

Art.-Gruppe 110
Article Group 110

4027

1/2"

22
tlg./pcs.



Steckschlüsselkoffer mit 22 Werkzeugen im hochwertigen Metallkoffer, metrisch

- ▶ Umschaltknarre 48 Zahn
- ▶ Stecknüsse 10 – 32 mm
- ▶ Zündkerzen Stecknüsse 16 + 21 mm
- ▶ Verlängerungen 125 + 250 mm

Industrial socket set with 22 assorted tools in metal case, metric

- ▶ Reversible ratchet 48 teeth
- ▶ Sockets 10 – 32 mm
- ▶ Spark plug sockets 16 + 21 mm
- ▶ Extension bars 125 + 250 mm

- 15 10 - 11 - 12 - 13 - 14 - 15 - 16 - 17 - 18 - 19 - 22 - 24 - 27 - 30 - 32 mm
- 2 16 + 21 mm
- 1 **48 Zahn**, Art. 5220
- 2 Verlängerungen 125 + 250 mm
- 1 3/8" (Knarre) x 1/2" (Nuss)
- 1 Kardangelenk

Größe/Size: 1/2" · tlg./pcs. 22 · **BxLxH/WxLxH:** 450x190x55 mm
Gewicht/Weight: 4.600 g



Art.-Nr./Art.-No.	€
4027	1/2" Steckschlüsselkoffer

1/4"+ 1/2" Steckschlüsselkoffer 108-teilig

1/4" + 1/2" Socket Set, 108 pieces



Art.-Gruppe 112
Article Group 112

108
tlg./pcs.



8653
48-Zahn-Knarren

8654
72-Zahn-Knarren

Steckschlüsselsatz mit 108 Werkzeugen, metrisch

- ▶ 2 Umschaltknarren 1/4" + 1/2", **48 ZAHN (8653)** oder 2 Umschaltknarren 1/4" + 1/2", **72 ZAHN (8654)**
- ▶ Stecknüsse 4 – 32 mm
- ▶ 1/4" Bit Stecknüsse für alle Schraubarbeiten

Socket set with 108 assorted tools, metric

- ▶ 2 ratchets 1/4" + 1/2", **48 TEETH (8653)** or 2 ratchets 1/4" + 1/2", **72 TEETH (8684)**
- ▶ Sockets 4 – 32 mm
- ▶ Bit sockets 1/4" for all screws

13	○ 4 - 4.5 - 5 - 5.5 - 6 - 7 - 8 - 9 - 10 - 11 - 12 - 13 - 14 mm		
8	○ 6 - 7 - 8 - 9 - 10 - 11 - 12 - 13 mm		
5	⊕ E4 - E5 - E6 - E7 - E8		
3	● 4 - 5.5 - 6.5 mm		
2	⊕ PH 1 - 2		
2	⊕ PZ 1 - 2		
4	● 3 - 4 - 5 - 6 mm		
7	⊕ TX8 - 10 - 15 - 20 - 25 - 27 - 30		
1	Kardangelenk		
2	Verlängerungen 50 + 75 mm		
1	Gleitgriff		
1	Steckgriff		
1	48 ZAHN , Art. 5200 oder/or 72 ZAHN , Art. 5201		
3	1,5 - 2 - 2,5 mm		

17	○ 10 - 11 - 12 - 13 - 14 - 15 - 16 - 17 - 18 - 19 - 20 - 21 - 22 - 24 - 27 - 30 - 32 mm		
5	○ 14 - 15 - 17 - 19 - 22 mm		
8	⊕ E10 - E11 - E12 - E14 - E16 - E18 - E20 - E22		
2	○ 16 + 21 mm		
1	3/8" (Knarre) x 1/2" (Nuss)		
2	Verlängerungen 125 + 250 mm		
1	1/2" (Knarre) x 5/16" (Bit)		
1	Kardangelenk		
1	48 ZAHN , Art. 5220 oder/or 72 ZAHN , Art. 5221		
3	● 8 - 10 - 12 mm		
2	⊕ PH 3 - 4		
2	⊕ PZ 3 - 4		
5	⊕ TX40 - 45 - 50 - 55 - 60		
5	● 7 - 8 - 10 - 12 - 14 mm		

Größe/Size	1/4" + 1/2"
tlg./pcs.	108
BxLxH/WxLxH	380x295x80 mm
Gewicht/Weight	7.000 g

Art.-Nr./Art.-No.	€
8653	1/4 + 1/2" Steckschlüsselk. 48 Z
8654	1/4 + 1/2" Steckschlüsselk. 72 Z

1/4" + 1/2" Werkzeugkoffer, 91-teilig

1/4" + 1/2" Tool Set, 91 pieces



Art-Gruppe 112
Article Group 112

91
tlg./pcs.

1/4"

1/2"

8655

48-Zahn-Knarren

8656

72-Zahn-Knarren



Werkzeugkoffer mit 91 Werkzeugen, metrisch

- ▶ 2 Umschaltknarren 1/4" + 1/2", 48 ZAHN (8655) oder 2 Umschaltknarren 1/4" + 1/2", 72 ZAHN (8656)
- ▶ Stecknüsse 4 – 24 mm
- ▶ Ringgabelschlüssel 8 - 10 - 12 - 13 - 14 - 17 mm
- ▶ Bits für jeden Einsatz
- ▶ Schraubendreher und Zangen

Tool set with 91 assorted tools, metric

- ▶ 2 ratchets 1/4" + 1/2", **48 TEETH (8655) or 2 ratchets 1/4" + 1/2", 72 TEETH (8656)**
- ▶ Sockets 4 – 24 mm
- ▶ Combination wrenches 8 - 10 - 12 - 13 - 14 - 17 mm
- ▶ Bits for all screws
- ▶ Screwdrivers and pliers

9	○ 4 - 5 - 6 - 7 - 8 - 9 - 10 - 11 - 12 mm	1/4"		1	Verlängerung 125 mm	
1	Verlängerung 75 mm			1	Kardangelen	
1	1/4" (Knarre) x 1/4" (Bit)			6	8 - 10 - 12 - 13 - 14 - 17 mm	
3	● 4.5 - 6.5 - 8 mm			9	1.5 - 2 - 2.5 - 3 - 4 - 5 - 6 - 8 - 10 mm	
3	⊕ PH 1 - 2 - 3			7	⊕ TX20 - 25 - 30 - 40 - 45 - 50 - 55	
3	⊕ PZ 1 - 2 - 3			6	● 4 - 5 - 6 - 8 - 10 - 12 mm	
7	⊕ TX10 - 15 - 20 - 25 - 27 - 30 - 40			1	Telefonzange 160 mm	
6	● 3 - 4 - 5 - 6 - 7 - 8 mm			1	Kombizange 180 mm	
1	48 ZAHN , Art. 5200 oder/or 72 ZAHN , Art. 5201			1	Wasserpumpenzange 250 mm	
1	Gleitgriff			3	● 8 x 150 mm - 6 x 100 mm - 6 x 38 mm	
1	Quergriff-Bitschraubendreher			1	⊕ PH 2 x 38 mm	
14	○ 8 - 10 - 11 - 12 - 13 - 14 - 15 - 16 - 17 - 18 - 19 - 21 - 22 - 24 mm	1/2"		2	⊕ PH 1 x 75 mm - PH 2 x 100 mm	
1	1/2" (Knarre) x 10 mm (Bit)					
1	48 ZAHN , Art. 5220 oder/or 72 ZAHN , Art. 5221					

Größe/Size: 1/4" + 1/2" · tlg./pcs. 91

BxLxH/WxLxH: 420x285x85 mm

Gewicht/Weight: 6.000 g

Art.-Nr./Art.-No.

€

8655 1/4" + 1/2" Werkzeugkoffer 48 Z

8656 1/4" + 1/2" Werkzeugkoffer 72 Z

1/4" + 3/8" + 1/2" proficraft Steckschlüssel-Koffer 182-teilig

1/4" + 3/8" + 1/2" proficraft Socket Set, 182 pieces



Art.-Gruppe 112
Article Group 112

1/4"

3/8"

1/2"

8663
48-Zahn-Knarren

8664
72-Zahn-Knarren

NEU/NEW



Steckschlüssel-Satz mit 182 Werkzeugen, metrisch

- ▶ 3 Umschaltknarren 1/4" + 3/8" + 1/2", **48 ZAHN (8663) oder**
- 3 Umschaltknarren 1/4" + 3/8" + 1/2", 72 ZAHN (8664)**

- ▶ Stecknüsse 4 – 32 mm

- ▶ 1/4" Bit-Stecknüsse für alle Schraubarbeiten

182
tlg./pcs.

Socket Set with 182 assorted Tools, metric

- ▶ 3 ratchets 1/4" + 3/8" + 1/2", **48 TEETH (8663) or**
- 3 ratchets 1/4" + 3/8" + 1/2", 72 TEETH (8664)**

- ▶ Sockets 4 – 32 mm

- ▶ Bit sockets 1/4" for all screws

- | | | | | |
|----|---|---|-------------|--|
| 13 | ○ | 4 - 4.5 - 5 - 5.5 - 6 - 7 - 8 - 9 - 10 - 11 - 12 - 13 - 14 mm | 1/4" | |
| 7 | ○ | 4 - 5 - 6 - 7 - 8 - 9 - 10 - mm | | |
| 5 | ⊕ | E4 - E5 - E6 - E7 - E8 | | |
| 4 | ● | 4 - 5.5 - 6.5 - 7 mm | | |
| 3 | ⊕ | PH 0 - 1 - 2 | | |
| 3 | ⊕ | PZ 0 - 1 - 2 | | |
| 4 | ● | 3 - 4 - 5 - 6 mm | | |
| 8 | ⊕ | T8 - T9 - T10 - T15 - T20 - T25 - T27 - T30 | | |
| 8 | ⊕ | T8 - T9 - T10 - T15 - T20 - T25 - T27 - T30 | | |
| 1 | | Kardangelenk | | |
| 2 | | Verlängerungen 50 + 100 mm | | |
| 1 | | Gleitgriff | | |
| 1 | | Steckgriff | | |
| 1 | | 48 ZAHN , Art. 5200 oder/or 72 ZAHN , Art. 5201 | | |
| 4 | ● | 3 - 4 - 5,5 - 6 mm | | |
| 5 | ⊕ | PH 0 - 1 - 2 - 2 - 3 mm | | |
| 5 | ⊕ | PZ 0 - 1 - 2 - 2 - 3 mm | | |
| 10 | ⊕ | TX10 - 10 - 15 - 20 - 20 - 25 - 25 - 27 - 30 - 40 | | |
| 6 | ● | 2 - 2,5 - 3 - 4 - 5 - 6 | | |
| 1 | | 1/4" (Knarre) x 1/4" (Bit) | | |

- | | | | | | |
|----|---|---|--------------|-------------|--|
| 3 | ● | 8 - 10 - 12 mm | 5/16" | | |
| 2 | ⊕ | PH 3 - 4 mm | | | |
| 2 | ⊕ | PZ 3 - 4 mm | | | |
| 6 | ⊕ | TX40 - 45 - 50 - 55 - 60 - 70 mm | | | |
| 6 | ⊕ | TX40 - 45 - 50 - 55 - 60 - 70 mm | | | |
| 5 | ● | 7 - 8 - 10 - 12 - 14 mm | | | |
| 10 | ○ | 10 - 11 - 12 - 13 - 14 - 15 - 16 - 17 - 18 - 19 mm | 3/8" | | |
| 6 | ○ | 10 - 11 - 12 - 13 - 14 - 15 mm | | | |
| 1 | | Kardangelenk | | | |
| 1 | | Verlängerung 150 mm | | | |
| 1 | | 48 ZAHN , Art. 5210 oder/or 72 ZAHN , Art. 5211 | | | |
| 1 | | 3/8" (Knarre) x 5/16" (Bit) | | | |
| 17 | ○ | 10 - 11 - 12 - 13 - 14 - 15 - 16 - 17 - 18 - 19 - 20 - 21 - 22 - 24 - 27 - 30 - 32 mm | | 1/2" | |
| 5 | ○ | 14 - 15 - 17 - 19 - 22 mm | | | |
| 8 | ⊕ | E10 - E11 - E12 - E14 - E16 - E18 - E20 - E24 | | | |
| 3 | ○ | 16 - 18 - 21 mm | | | |
| 1 | | 3/8" (Knarre) x 1/2" (Nuss) | | | |
| 2 | | Verlängerungen 125 + 250 mm | | | |
| 1 | | Kardangelenk | | | |
| 1 | | 48 ZAHN , Art. 5220 oder/or 72 ZAHN , Art. 5221 | | | |
| 1 | | 1/2" (Knarre) x 5/16" (Bit) | | | |
| 7 | | 1,27 - 1,5 - 2 - 2,5 - 3 - 4 - 5 mm | | | |

Größe/Size: 1/4" + 3/8" + 1/2" · tlg./pcs. 182

BxLxH/WxLxH: 400x310x82 mm

Gewicht/Weight: ca. 8.500 g

Art.-Nr./Art.-No.	€
8663 1/4"+3/8"+1/2" proficraft Steckschlüsselk. 48 Z	
8664 1/4"+3/8"+1/2" proficraft Steckschlüsselk. 72 Z	

1/2" Werkzeugkoffer, 84-teilig

1/2" Tool Case, 84 pieces

8688

1/2"

NEU/NEW



Werkzeugkoffer











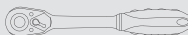

mit 84 Werkzeugen, metrisch

84
tlg./pcs.

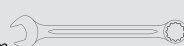



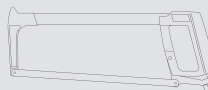

- ▶ **Universell einsetzbare Werkzeugbestückung**
- ▶ **Übersichtlich strukturierte Anordnung der Werkzeuge**
- ▶ **Hochwertiger, dreistufiger Metallkoffer**
- ▶ **Ergonomisches Handling durch schaumummantelte, anklappbare Bügelgriffe**

Tool Case with 84 assorted Tools, metric

- ▶ **Versatile usable Tools**
- ▶ **Clearly structured arrangement of the tools**
- ▶ **High-quality, three-level metal case**
- ▶ **Ergonomic handling by foam-encased, foldable handles**

- 14 ○ 10 - 12 - 13 - 14 - 15 - 16 - 17 - 19 - 20 - 22 - 24 - 27 - 30 - 32 mm 
- 2 ○ 16 - 21 mm 
- 1 **48 ZAHN**, Art. 5220 
- 2 Verlängerungen 125 + 250 mm 
- 1 Kardangelen 
- 1 3-Wege-Adapter 3/8" x 1/2" 
- 1 Hammer 300 g 
- 8 Ringgabelschlüssel 10 - 11 - 12 - 13 - 14 - 17 - 19 - 22 mm 
- 1 Rollgabelschlüssel 8" / 200 mm 
- 9 1.5 - 2 - 2.5 - 3 - 4 - 5 - 6 - 8 - 10 
- 1 Kombizange 175 mm 
- 1 Seitenschneider 
- 1 Telefonzange 150 mm 

- 4 Wasserpumpenzange 250 mm 
- 2 PH 1 x 75 mm + PH 2 x 100 mm 
- 2 Schlitz 5.5 x 75 mm + 6.5 x 100 mm 
- 2 Magnetischer Bitschraubendreher 
- 1 Universalschere 175 mm 
- 1 Metalbügeleisen 
- 1 Maßband 5 m 
- 1 Wasserwaage 300 mm 
- 2 Bit-Box, 31-teilig 

- 5 ⊕ PH 0 - PH 1 - PH 2 - PH 3 - PH 4 
- 5 ⊕ PZ 0 - PZ 1 - PZ 2 - PZ 3 - PZ 4 
- 6 ⊕ TORX® T10 - 15 - 20 - 25 - 27 - 30 
- 7 ⊖ Schlitz: 3 - 4 - 5 - 5,5 - 6 - 6,5 - 7 mm 
- 1 ⊙ Inbus: 1,5 - 2 - 2,5 - 3 - 4 - 5 - 6 mm 
- 1 1 Bit-Halter 60 mm 

Größe/Size 1/2"
tlg./pcs. 84
BxLxH/WxLxH 490x225x380 mm
Gewicht/Weight 13.500 g

Art.-Nr./Art.-No. €

8688 1/2" Werkzeugkoffer mit 84 Werkzeugen

1/4" + 1/2" Universal-Werkzeug-Koffer, 149-teilig

1/4" + 1/2" Universal Tool Case, 149 pieces



Art.-Gruppe 113
Article Group 113

8681

1/4"

1/2"

149
tlg./pcs.



8681K
Koffer, leer
empty case

12	○	4 - 4,5 - 5 - 5,5 - 6 - 7 - 8 - 9 - 10 - 11 - 12 - 13 mm		
2		Verlängerungen 50 + 100 mm		1/4"
1		48 ZAHN , Art. 5200		
1		Gleitgriff 110 mm		
1		Kardangelenk		
1		1/4" (Knarre) x 1/4" (Bit)		
3	●	4,5 - 5,5 - 6,5 mm		
6	+	2x PH 1 - 2 - 3		
6	+	2x PZ 1 - 2 - 3		
9	⊕	TX8 - 9 - 10 - 15 - 20 - 25 - 27 - 30 - 40		
6	●	3 - 4 - 5 - 6 - 7 - 8 mm		
1		Bit-Halter 60 mm		
1		1/4" x 1/4"		
1		Magn. Bit-Schraubendreher		
14	○	10 - 13 - 14 - 15 - 16 - 17 - 18 - 19 - 21 - 22 - 24 - 27 - 30 - 32 mm		1/2"
2		Verlängerungen 125 + 250 mm		
1		48 ZAHN , Art. 5220		
1		Kardangelenk		
1		1/2" x 3/8"		
1		1/2" (Knarre) x 5/16" (Bit)		
1		Teleskop Magnetheber		
1		Rollmeter 5 m		
9	●	1,5 - 2 - 2,5 - 3 - 4 - 5 - 6 - 8 - 10 mm		
10		8 - 10 - 11 - 12 - 13 - 14 - 15 - 17 - 19 - 22 mm		
1		Telefonzange 160 mm		
1		Kombizange 180 mm		
1		Wasserpumpenzange 240 mm		
1		Seitenschneider 160 mm		
1		Flechterzange 250 mm		
2	+	PH 1 - 2		
1	+	PZ 2		
3	●	3,5 - 5,5 - 6,5 mm		
1	●	110 bis/up to 250 V Spannungsprüfer		
1		Universalmesser		
1		Hammer 300 g		
1		Metallsäge 300 mm		
1		Schieblehre 0 - 150 mm		
5		Schlag- und Meißelsatz		
1		Halbrundfeile		
1		Spachtel		
1		Stechbeitel		
1		Zimmermanns-Bleistift		
1		Taschenlampe		
20		Kabelbinder 3,5 x 150 mm		
2	●	8 - 10 mm		
2	+	PH 3 - 4		
4	⊕	TX40 - 45 - 50 - 55		
3	●	10 - 12 - 14 mm		

Größe/Size: 1/4" + 1/2" · tlg./pcs. 149

BxLxH/WxLxH: 460x330x145 mm · Gewicht/Weight: 12.240 g

Art.-Nr./Art.-No.

8681

1/4" + 1/2" Werkzeug-Koffer

€

1/4" + 1/2" Universal-Werkzeug-Trolley, 130-teilig

1/4" + 1/2" Universal Tool Trolley, 130 pieces



Art.-Gruppe 113
Article Group 113



4963-01

1/4"

1/2"

130
tlg./pcs.



- Robuste Rollen/
Robust Castors
- Stabile FüÙe/
Solid Feet
- Abschließbare Bügelschlösser/
Lockable U-Locks
- Einrastender Teleskopgriff/
Telescopic Snap-Handle
- Haltbare Scharniere/
Hard-Wearing Hinges

4963
Trolley, leer
empty trolley

12	4 - 4,5 - 5 - 5,5 - 6 - 7 - 8 - 9 - 10 - 11 - 12 - 13 mm	
2	Verlängerungen 100 + 150 mm	1/4"
1	48 ZAHN , Art. 5200	
1	Steckgriff	
1	Kardangelenk	
1	1/4" (Knarre) x 1/4" (Bit)	
3	4.5 - 5,5 - 6,5 mm	
6	2x PH 1 - 2 - 3	
6	2x PZ 1 - 2 - 3	
9	TX8 - 9 - 10 - 15 - 20 - 25 - 27 - 30 - 40	
6	3 - 4 - 5 - 6 - 7 - 8 mm	
1	Bit-Halter 60 mm	
1	Bit-Knarre, Art. 2700	
1	Magn. Bit-Schraubendreher	
16	10 - 11 - 12 - 13 - 14 - 15 - 16 - 17 - 18 - 19 - 21 - 22 - 24 - 27 - 30 - 32 mm	1/2"
2	Verlängerungen 125 + 250 mm	
1	48 ZAHN , Art. 5220	
1	Kardangelenk	
1	Gleitgriff 300 mm	
1	Teleskop Magnetheber	
1	Rollmeter 5 m	
9	1.5 - 2 - 2.5 - 3 - 4 - 5 - 6 - 8 - 10 mm	
9	TX10 - 15 - 20 - 25 - 27 - 30 - 40 - 45 - 50	
12	8 - 9 - 10 - 11 - 12 - 13 - 14 - 16 - 17 - 18 - 19 - 22 mm	
1	Telefonzange 200 mm	
1	Kombizange 180 mm	
1	Wasserpumpenzange 250 mm	
1	Seitenschneider 160 mm	
1	Flechtermesser 250 mm	
2	PH 1 - 2	
2	PZ 1 - 2	
2	4,0 - 8,0 mm	
1	110 bis/up to 250 V Spannungsprüfer	
1	VDE/isolated 3,0 mm	
2	VDE/isolated PH1 - 2	
1	Universalmesser	
1	Hammer 300 g	
1	Metallsäge 260 mm	
1	Schieblehre 0 - 150 mm	
1	Aluminium-Wasserwaage 400 mm	
5	Schlag- und Meißelsatz	
1	Rollgabelschlüssel 10" / 250 mm	

Größe/Size: 1/4" + 1/2" · tlg./pcs. 130

BxLxH/WxLxH: 460x390x170 mm

Gewicht/Weight: ca. 17.500 g

Art.-Nr./Art.-No.

4963-01 1/4" + 1/2" Universal-Trolley

€

3/8" Universal-Werkzeug-Koffer KOMPAKT, 164-teilig

3/8" Universal Tool Case COMPACT, 164 pieces

PROJAHN
proficraftArt.-Gruppe 113
Article Group 113**8682**

3/8"

164
tlg./pcs.**8682K**
Koffer, leer
empty case

17	○	6 - 7 - 8 - 9 - 10 - 11 - 12 - 13 - 14 - 15 - 16 - 17 - 18 - 19 - 21 - 22 - 24 mm	
1		Verlängerung 150 mm	
1		48 ZAHN , Art. 5210	
1		Kardangelenke	
1		3/8" (Knarre) x 1/4" (Bit)	
3	●	4,5 - 5,5 - 6,5 mm	
6	+	2x PH 1 - 2 - 3	
6	+	2x PZ 1 - 2 - 3	
9	⊕	TX8 - 9 - 10 - 15 - 20 - 25 - 27 - 30 - 40	
6	●	3 - 4 - 5 - 6 - 7 - 8 mm	
1		Bit-Halter 60 mm	
1		Bit-Schraubendreher	
2	+	PH 1 - 2	
1	+	PZ 2	
3	●	3,0 - 5,5 - 6,0 mm	
1	●	125 bis/up to 230 V Spannungsprüfer	
4		Präzisionsschraubendreher-Satz ● 2,0 - 3,0 - 4,0 mm + PH00 - 0 - 1	
1		Teleskop Magnetheber	

9	●	1.5 - 2 - 2.5 - 3 - 4 - 5 - 6 - 8 - 10 mm	
10		8 - 10 - 11 - 12 - 13 - 14 - 15 - 17 - 19 - 22 mm	
1		Telefonzange 200 mm	
1		Kombizange 180 mm	
1		Wasserpumpenzange 240 mm	
1		Seitenschneider 160 mm	
1		Flechterzange 250 mm	
1		Universalschere 180 mm	
1		Crimpzange 240 mm	
40		Kabelschuhe	
1		Universalmesser	
5		Ersatzklingen als 1 Pack	
1		Hammer 300 g	
1		Metallsäge 260 mm	
3		Sägeblätter	
20		Kabelbinder 3,5 x 150 mm	
1		Wasserwaage 300 mm	
1		Rollmeter 3 m	

Größe/Size: 3/8" · tlg./pcs. 164
BxLxH/WxLxH: 425x280x130 mm
Gewicht/Weight: 9.400 g

Art.-Nr./Art.-No.

8682

3/8" Universal-Werkzeug-Koffer

€

1/4" Schreiner-Werkzeug-Koffer, 92-teilig

1/4" Carpenter Tool Case, 92 pieces

8684

1/4"

92
tlg./pcs.



8684K
Koffer, leer
empty case

3	● 4,5 - 5,5 - 6,5 mm	1/4"		9	● 1.5 - 2 - 2.5 - 3 - 4 - 5 - 6 - 8 - 10 mm	
6	⊕ 2x PH 1 - 2 - 3			8	8 - 10 - 11 - 12 - 13 - 14 - 17 - 19 mm	
6	⊕ 2x PZ 1 - 2 - 3			5	Holzbohrer 4x75 - 5x85 - 6x90 - 8x110 - 10x120 mm	
9	⊗ TX8 - 9 - 10 - 15 - 20 - 25 - 27 - 30 - 40			1	Beißzange 200 mm	
6	● 3 - 4 - 5 - 6 - 7 - 8 mm			1	Seitenschneider 150 mm	
1	Bit-Halter 60 mm			1	Holzfeile, flach 150 mm	
1	Bit-Schraubendreher			1	Holzfeile, halbrund 150 mm	
2	⊕ PH 1 - 2			3	Hand-Raspel	
4	● 3 - 4 - 5,5 - 6,5 mm			1	Universalschere	
1	● 120 bis/up to 250 V Spannungsprüfer			1	Universalmesser	
3	Zimmermanns-Bleistift			5	Ersatzklingen als 1 Pack	
1	Gliedermaßstab aus Holz, 2 m			1	Schlosserhammer »Französische Form«	
1	Schmiege 230 mm			1	Kleinhandsägebogen 150 mm	
1	Vorstecher			1	Handsäge 229 mm	
1	Hobel 170 mm			1	Wasserwaage 400 mm	
1	Winkel 90° 300 mm			5	Schlag- und Meißelsatz	
				5	Holz-Stechbeitel 6 - 12 - 16 - 20 - 26 mm	

Größe/Size: 1/4" · tlg./pcs. 92
BxLxH/WxLxH: 460x330x145 mm
Gewicht/Weight: 9.060 g

Art.-Nr./Art.-No. 8684 €
1/4" Schreiner-Werkzeug-Koffer

1/4" + 1/2" Elektro-Werkzeug-Koffer, 128-teilig

1/4" + 1/2" Electrician Tool Case, 128 pieces



Art.-Gruppe 113
Article Group 113

8683

1/4"

1/2"

128
tlg./pcs.



8683K
Koffer, leer
empty case

12	○	4 - 4,5 - 5 - 5,5 - 6 - 7 - 8 - 9 - 10 - 11 - 12 - 13 mm	1/4"		9	●	1.5 - 2 - 2.5 - 3 - 4 - 5 - 6 - 8 - 10 mm	
1		Verlängerungen 50 + 100 mm			9		8 - 10 - 11 - 12 - 13 - 14 - 17 - 19 - 22 mm	
1		48 ZAHN , Art. 5200			1		Telefonzange 150 mm	
1		Gleitgriff 300 mm			1		Kombizange 150 mm	
1		Kardangelenk			1		Seitenschneider 150 mm	
3	●	4,5 - 5,5 - 6,5 mm			1		VDE Abisolierzange 150 mm	
6	+	2x PH 1 - 2 - 3			1		VDE Elektriker-Messer 150 mm	
6	+	2x PZ 1 - 2 - 3			1		Universalschere	
9	⊗	TX8 - 9 - 10 - 15 - 20 - 25 - 27 - 30 - 40			1		Universalmesser	
6	●	3 - 4 - 5 - 6 - 7 - 8 mm			1		Ersatzklingen als 1 Pack	
1		Bit-Halter 60 mm			1		Hammer 400 g	
1		Bit-Schraubendreher			1		Handsägebogen 150 mm	
2	+	VDE/isolated PH1 - 2			20		Kabelbinder 3,5 x 150 mm	
4	●	VDE/isolated 2,5 - 4 - 5,5 - 6,5 mm			1		Wasserwaage 400 mm	
1	●	120 bis/up to 230 V Spannungsprüfer			1		Rollmeter 5 m	
12	○	10 - 11 - 12 - 13 - 14 - 15 - 16 - 17 - 18 - 19 - 21 - 22 mm	1/2"		1		Rollgabelschlüssel 8" / 200 mm	
1		Verlängerung 125 mm			3		Zimmermanns-Bleistift	
1		48 ZAHN , Art. 5220			1		Gliedermaßstab aus Holz, 2 m	
1		Kardangelenk			1		Spachtel	
					1		Flachmeißel 200 mm	
					1		Spitzmeißel 200 mm	

Größe/Size: 1/4" + 1/2" · tlg./pcs. 128

BxLxH/WxLxH: 460x330x145 mm

Gewicht/Weight: 10.200 g

Art.-Nr./Art.-No.

8683

1/4" + 1/2" Elektro-Werkzeug-Koffer

€

1/4" + 1/2" Sanitär-Werkzeug-Koffer, 95-teilig

1/4" + 1/2" Plumber Tool Case, 95 pieces

8685

1/4"

1/2"

95
tlg./pcs.



8685K
Koffer, leer
empty case

3	4.5 - 5,5 - 6,5 mm	1/4"		10	8x9 - 10x11 - 12x13 - 14x15 - 16x17 - 18x19 - 20x22 - 21x23 - 24x27 - 30x32 mm	
6	2x PH1 - 2 - 3			1	Wasserpumpenzange 250 mm	
6	2x PZ1 - 2 - 3			1	Eckrohrzange	
9	TX8 - 9 - 10 - 15 - 20 - 25 - 27 - 30 - 40			1	Hammer 600 g	
6	3 - 4 - 5 - 6 - 7 - 8 mm			1	Flachmeißel 200 mm	
1	60 mm Bit-Halter			1	Spitzmeißel 200 mm	
1	Magnetischer Bit- Schraubendreher			1	Handsägebogen 150 mm	
13	10 - 11 - 12 - 13 - 14 - 15 - 16 - 17 - 18 - 19 - 21 - 22 - 24 mm	1/2"		1	Feile, halbrund, 150 mm	
1	Verlängerung 125 mm			1	Spachtel	
1	Kardangelenk			3	Zimmermanns-Bleistift	
2	PH1 - 2			1	Sanitärkreuzschlüssel 200 x 200 mm	
4	3 - 4 - 5,5 - 6,5 mm			1	Rohrabschneider 3 - 30 mm	
1	120 bis 250 V Spannungsprüfer			1	Rohrabschneider 3 - 42 mm	
1	Gliedermaßstab aus Holz, 2 m			1	Umsteckknarre für 1/2" Vierkant-Antrieb	
1	Wasserwaage 400 mm			1	Vierkant-Adapter 1/2"	
1	Drahtbürste			1	Stufenschlüssel 5-stufig	
9	1.5 - 2 - 2.5 - 3 - 4 - 5 - 6 - 8 - 10 mm			1	Standhahn-Mutterschlüssel	
				1	Spezienschlüssel Sanitär	

Größe/Size: 1/4" + 1/2" · tlg./pcs. 95

BxLxH/WxLxH: 460x330x145 mm

Gewicht/Weight: 12.760 g

Art.-Nr./Art.-No.

8685 1/4" + 1/2" Sanitär-Werkzeug-Koffer

€

1/4" Werkzeugtasche, 106-teilig

1/4" Tool Bag, 106 pieces



Art.-Gruppe 113
Article Group 113

8686

1/4"

NEU/NEW



394901
Tasche, leer
Empty bag



Werkzeugtasche mit 106 Werkzeugen, metrisch

106
tlg./pcs.

- ▶ Umfangreiche, universelle Bestückung
- ▶ 1/4" proficraft-Satz, 45-tlg. (8659)
- ▶ Doppelgabelschlüssel-Set 6-tlg.
- ▶ Ermüdungsarmes Tragen durch ergonomisches Design
- ▶ Zusätzlicher Stauraum vorhanden

Tool Bag with 106 assorted Tools, metric

- ▶ High quality workmanship and materials
- ▶ 1/4" proficraft Set, 45 pcs. (8659)
- ▶ Double open End wrench set, 6 pcs.
- ▶ Easy carrying due to ergonomic design
- ▶ Additional storage space inside

- 3 4,5 - 5,5 - 6,5 mm 1/4"
- 6 2x PH 1 - PH 2 - PH 3
- 6 2x PZ 1 - PZ 2 - PZ 3
- 9 T8 - T9 - T10 - T15 - T20
T25 - T27 - T30 - T40
- 6 3 - 4 - 5 - 6 - 7 - 8 mm
- 1 Bit-Halter 60 mm
- 13 4 - 4,5 - 5 - 5,5 - 6 - 7 - 8 -
9 - 10 - 11 - 12 - 13 - 14 mm
- 3 4 - 5,5 - 7 mm
- 3 PH 1 - PH 2 - PH 3
- 3 PZ 1 - PZ 2 - PZ 3
- 6 3 - 4 - 5 - 6 - 7 - 8 mm
- 7 T10 - T15 - T20 -
T27 - T30 - T40

- 1 **48 ZAHN**,
Art. 5200
- 1 Steckgriff
- 2 Verlängerungen
50 + 100 mm
- 1 Gleitgriff
- 1 Kardangelenk
- 1 Verlängerung
flex. 150 mm
- 1 1/4" x 1/4"
- 3 1,5 - 2 - 2,5 mm
- 6 Doppelgabelschlüssel
6x7 - 8x9 - 10x11 - 12x13 - 14x15 -
16x17 mm in Rolltasche



- 9 Sechskant-Kugelpf-Winkelstiftschlüssel
1,5 - 2 - 2,5 - 3 - 4 - 5 - 6 - 8 - 10 mm
- 1 Rollgabelschlüssel 10" / 250 mm
- 1 Telefonzange 150 mm
- 1 Kombizange 175 mm
- 1 Wasserpumpenzange
- 1 Seitenschneider 150 mm
- 2 PH1 - PH 2
- 2 5,5 - 6,5 mm
- 1 Hammer 300 g
- 1 Magn. Bitschraubendreher
- 1 Universalmesser
- 1 LED-Taschenlampe
- 1 Gliedermaßstab 2 m

Größe/Size 1/4"
tlg./pcs. 106
BxLxH/WxLxH 340x440x250 mm
Gewicht/Weight 7.200 g

Art.-Nr./Art.-No.		€
8686	1/4" Werkzeugtasche mit 106 Werkzeugen	
394901	1/4" Werkzeugtasche, unbestückt	



PROForm-Box
Koffersystem für PROForm-Werkstattwagen-Einlagen

PROForm-Box
Cases for PROForm-Inlays

Stellen Sie sich Ihren eigenen Werkzeugkoffer zusammen oder machen Sie Ihre Werkstattwagen-Werkzeuge noch mobiler.

Customize your own Tool Set or make your Roller Cabinet Tools available.



PROJAHN Werkstattwagen

PROJAHN Roller Cabinets



PROJAHN PROForm-Box 1

PROJAHN PROForm-Box 1



PROJAHN PROForm-Box 3

PROJAHN PROForm-Box 3

PROForm-Box – Koffersystem für PROForm-Werkstattwagen-Einlagen

PROForm-Box – Cases for PROForm Inlays

Art.-Gruppe 171/179
Article Group 171/179

5953

PROForm-Box 1: Mobiler Koffer für eine PROForm-Werkzeug-Einlage (395 x 186 mm)

PROForm-Box 1: Mobile Case for One PROForm Tool Inlay (395 x 186 mm)

Stellen Sie sich Ihren eigenen Werkzeugkoffer zusammen oder machen Sie Ihre Werkstattwagen-Werkzeuge noch mobiler!

Customize your own Tool Set or make your Roller Cabinet Tools available!

- ▶ **INDIVIDUELL und BEQUEM:** Konfigurieren Sie Ihren eigenen Werkzeugkoffer oder wählen Sie aus unseren Topseller-Konfigurationen
 - ▶ **KOMPAKT:** Platzsparend und daher ideal für unterwegs
 - ▶ **MOBIL und FLEXIBEL:** Benötigte Werkzeug-Einlage vom Werkstattwagen in die PROForm-Box umpacken und mitnehmen
 - ▶ **STABIL und LANGLEBIG:** Sichere und saubere Werkzeugaufbewahrung
-
- ▶ *INDIVIDUAL and COMFORTABLE:* Customize your own tool set or choose from our top-seller configurations
 - ▶ *COMPACT:* Space saving and therefore ideal for mobile use
 - ▶ *MOBILE and FLEXIBLE:* PROForm-Box is able to fit one PROForm inlay from your roller cabinet and makes your tools mobile
 - ▶ *DURABLE:* Tools are secured to be shock and jolt-proof

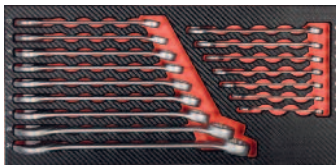

5953-011
PROForm-BOX mit Einlage Ringgabelschlüssel/ PROForm-BOX incl. Combination Wrench Inlay



5953-021
PROForm-BOX mit Einlage Doppelgabelschlüssel/ PROForm-BOX incl. Double Open End Wrench Inlay

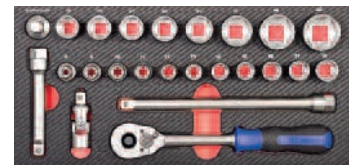

5953-131
PROForm-BOX mit Einlage 1/2" Steckschlüssel/ PROForm-BOX incl. 1/2" Socket Inlay



5953-065
PROForm-BOX mit Einl. PH-/PZ-/Schlitz-Schraubendr./PROForm-BOX incl. PH-/PZ-/Slotted Screwdriver Inlay



5953-082
PROForm-BOX mit Einlage Zangen/ PROForm-BOX incl. Pliers Inlay



5953-101
PROForm-BOX mit Einlage Schlagwerkzeuge/ PROForm-BOX incl. Hammer and Punch Inlay

Weitere PROForm-Werkstatteinlagen ab Seite /
More PROForm Inlays for Roller Cabinet from Page **H 36**

Art.-Nr./Art.-No.	Beschreibung/Description	tlg./pcs	€
5953	PROForm-Box 1 – Leerkoffer/Empty Box		
5953-011	PROForm-Box mit Einlage Ringgabelschlüssel/incl. Combination Wrench Inlay	16	
5953-021	PROForm-Box mit Einlage Doppelgabelschlüssel/incl. Double Open End Wrench Inlay	8	
5953-131	PROForm-Box mit Einlage 1/2" Steckschlüssel/incl. 1/2" Socket Inlay	24	
5953-065	PROForm-Box mit Einlage PH-/PZ-/Schlitz-Schraubendreher/incl. PH-/PZ-/Slotted Screwdriver Inlay	8	
5953-082	PROForm-Box mit Einlage Zangen/incl. Pliers Inlay	4	
5953-101	PROForm-Box mit Einlage Schlagwerkzeuge/incl. Hammer and Punch Inlay	6	

PROForm-Box – Koffersystem für PROForm-Werkstattwagen-Einlagen

PROForm-Box – Cases for PROForm Inlays

Art.-Gruppe 171
Article Group 171

5954

PROForm-Box 3: Mobiler Koffer für eine PROForm-Werkzeug-Einlage (395 x 560 mm) oder drei Werkzeug-Einlagen (395 x 186 mm)

PROForm-Box 3: Mobile Case for One PROForm Tool Inlay (395 x 560 mm) or Three Tool Inlays (395 x 186 mm)

Stellen Sie sich Ihren eigenen Werkzeugkoffer zusammen oder machen Sie Ihre Werkstattwagen-Werkzeuge noch mobiler!

Customize your own Tool Set or make your Roller Cabinet Tools available!

- ▶ **INDIVIDUELL:** Konfigurieren Sie Ihren eigenen Werkzeugkoffer aus bis zu drei PROForm-Einlagen
- ▶ **BEQUEM:** Oder wählen Sie aus unseren Topseller-Konfigurationen
- ▶ **MOBIL und FLEXIBEL:** Benötigte Werkzeug-Einlage vom Werkstattwagen in die PROForm-Box umpacken und mitnehmen
- ▶ **STABIL und LANGLEBIG:** Sichere und saubere Werkzeugaufbewahrung

- ▶ *INDIVIDUAL:* Customize your own tool set from up to three PROForm inlays
- ▶ *COMFORTABLE:* Or choose from our top-seller configurations
- ▶ *MOBILE and FLEXIBLE:* PROForm-Box is able to fit up to three PROForm inlays from your roller cabinet and makes your tools mobile
- ▶ *DURABLE:* Tools are secured to be shock and jolt-proof



5954-001 - Set, 48-tgl./48 pcs.
PROForm-BOX Set bestehend aus/
composed of 5999-011 + 5999-131 + 5999-065



5954-002 - Set, 39-tgl./39 pcs.
PROForm-BOX Set bestehend aus/
composed of 5999-041 + 5999-531 + 5999-082



5954-003 - Set, 18-tgl./18 pcs.
PROForm-BOX Set bestehend aus/
composed of 5999-101 + 5999-065 + 5999-082

Weitere PROForm-Werkstatteinlagen ab Seite /
More PROForm Inlays for Roller Cabinet from Page **H 36**

Art.-Nr./Art.-No.	Beschreibung/Description	tlg./pcs	€
5954	PROForm-Box 3 – Leerkoffer/Empty Box		
5954-001	PROForm-Box Set 3 bestehend aus/composed of 5999-011 + 5999-131 + 5999-065	48	
5954-002	PROForm-Box Set 3 bestehend aus/composed of 5999-411 + 5999-531 + 5999-082	39	
5954-003	PROForm-Box Set 3 bestehend aus/composed of 5999-101 + 5999-065 + 5999-082	18	



Ergonomisches Design

Ergonomic Design

- ▶ **Sicherer Halt und ermüdungsfreies Arbeiten durch ergonomisch an die Hand angepasste Griffform**
- ▶ **2-Komponentenmaterial – bruchsicher, stabiler Kern und griffige Ummantelung mit hoher Rutschhemmung**
- ▶ **Hoher Abgleitschutz durch spezielle Daumenmulden**
- ▶ **Geringere Belastung für Gelenke bei gleichzeitig höherem Drehmoment**
- ▶ **Leichte Einhandbedienung durch Schnelllöseknopf und Richtungsumschalter**
- ▶ *Secure grip and fatigue-free working due to ergonomically to the hand designed ratchet handle*
- ▶ *Two-component material – robust core combined with an ergonomic, slip-resistant surface*
- ▶ *High slip protection due to specially adapted thumb grips*
- ▶ *Less strain on joints combined with a higher torque*
- ▶ *Easy one-handed operation because of quick-release button and direction lever*

EINGETRAGENES DESIGN

REGISTERED DESIGN



Profi-Qualität

Professional Quality

- ▶ **Höchstes Qualitätsniveau für anspruchsvolle Anwender**
- ▶ **Präzision und Belastbarkeit weit über DIN-/ISO-Normen**
- ▶ **Hält extremen Drehmomenten bis 650 Nm stand²**
- ▶ **Leichtgängiger, hochpräziser Knarrenmechanismus**
- ▶ **Hohe Öl- und Säurebeständigkeit**
- ▶ *Highest level of quality for demanding users*
- ▶ *Precision and durability far beyond DIN/ISO standards*
- ▶ *Withstands extreme torques up to 650 Nm²*
- ▶ *Smooth-running, high-precision ratchet mechanism*
- ▶ *High oil and acid resistance*

Leistungsstarker Service

Powerful Support

- ▶ **PROJAHN Qualitätsversprechen – 25 Jahre Garantie¹**
- ▶ **Schneller Reparaturservice im Garantiefall**
- ▶ *PROJAHN's promise of quality – 25 years warranty¹*
- ▶ *Fast repair service during warranty time*

¹ Entsprechend unserer allgemeinen Garantiebedingungen / ¹ According to our general warranty conditions

² 1/2" PROJAHN-Umschaltknarre 39012900 / ² PROJAHN ratchet handle 39012900



1/4" + 3/8" + 1/2" + 3/4" + 1" Umschaltknarren

1/4" + 3/8" + 1/2" + 3/4" + 1" Ratchet Handle



Art.-Gruppe 120
Article Group 120

PROJAHN Umschaltknarren

Ratchet Handle

Art.-Nr./Art.-No.	Größe/Size
39014900	1/4" 36 Z, 90 Nm, 147 mm
39014900-1	Reparatur Set für 39014900
39038900	3/8" 38 Z, 280 Nm, 195 mm
39038900-1	Reparatur Set für 3903890
39012900	1/2" 40 Z, 640 Nm, 265 mm
39012900-1	Reparatur Set für 39012900



NEU/NEW

3/4" Umschaltknarre

Ratchet Handle

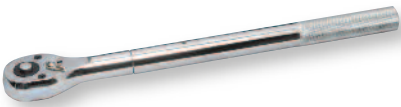

Art.-Nr./Art.-No.	Größe/Size	€
400001	3/4"	

1" Umschaltknarre

Ratchet Handle



Art.-Nr./Art.-No.	Größe/Size	€
500000	1"	

Universalgriff

Universal Handle

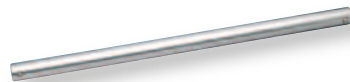

Art.-Nr./Art.-No.	Länge/Length	€
508560	500 mm	

U.S. Umschaltknarren

Ratchet Handle, U.S. Style



Art.-Nr./Art.-No.	Größe/Size
4208	1/4" 36 Z, 90 Nm, 147 mm
4200-1	Reparatur Set für 4208
4218	3/8" 38 Z, 280 Nm, 195 mm
4210-1	Reparatur Set für 4218
4228	1/2" 40 Z, 640 Nm, 265 mm
4220-1	Reparatur Set für 4228

1/4" + 3/8" + 1/2" + 3/4" + 1" Umschaltknarren

1/4" + 3/8" + 1/2" + 3/4" + 1" Ratchet Handle

Art.-Gruppe 120
Article Group 120**Xi-on** MULTISTECKNUS**Feinzahn-Umschaltknarren mit 2-Komponenten-Griff**
Ratchet with 2K-Handle

Art.-Nr./Art.-No.	Größe/Size
5205	1/4" 72 Z, 70 Nm, 140 mm
5205-1	Reparatur Set für 5205
5215	3/8" 72 Z, 225 Nm, 191 mm
5215-1	Reparatur Set für 5215
5225	1/2" 60 Z, 600 Nm, 260 mm
5225-1	Reparatur Set für 5225



PROFESSIONAL PLUS STANDARD

Feinzahn-Umschaltknarren mit Drehgriff
Ratchet with Twist Handle

Art.-Nr./Art.-No.	Größe/Size	€
5204	1/4" 60 Z, 74 Nm, 182 mm	
5214	3/8" 60 Z, 242 Nm, 243 mm	
5224	1/2" 60 Z, 614 Nm, 292 mm	

- ▶ Das ideale Werkzeug für enge Arbeitsbereiche
 - z. B. an Auspuffanlagen, Stellmotoren, Heizungs- und Klimaanlage sowie am Automatikgetriebe u.v.m.
- ▶ Extrem leichte Ratschenfunktion durch Drehen des Zwei-Komponenten-Griffes
- ▶ Auch zum Einsatz als 'normale' Ratsche mit Feinverzahnung (60 Zähne) verwendbar
- ▶ Zusätzlich eine robuste 1/4" (6,35 mm)-Vierkantaufnahme zum Aufstecken einer Verlängerung oder eines T-Stücks
- ▶ Umschaltung von Rechts- auf Linkslauf durch Durchstecken des Antrieb-Vierkants

- ▶ The perfect tool for tight application area
 - e.g. for exhaust systems, motors, heating and air conditioning systems, automatic gearbox, etc.
- ▶ Extremely easy ratchet function by turning the two-component handle
- ▶ Also usable as a 'usual' ratchet handle with 60 teeth
- ▶ Additionally with a sturdy 1/4" (6,35 mm) square drive to plug an extension or a t-handle
- ▶ Reversible from right to left drive



Ideal für enge Stellen

Ideal for tight areas



1/4" + 3/8" + 1/2" + 3/4" + 1" Umschaltknarren

1/4" + 3/8" + 1/2" + 3/4" + 1" Ratchet Handle

Art.-Gruppe 120
Article Group 120**1/2" verlängerbare Umschaltknarre mit 3 Griffen**

1/2" Extension Ratchet Handle

Art.-Nr./Art.-No. Größe/Size €

4298	1/2" Knarre
4298-1	Reparatur Set für 4298



- ▶ Robuste Umschaltknarre für alle Einsatzbereiche
- ▶ Verlängerbar von 150 auf 290 oder 500 mm
- ▶ Ideale Kraftübertragung durch großen Hebel
- ▶ Umschaltung von Rechts- auf Linkslauf
- ▶ Inkl. Schnelllöseknopf
- ▶ Für hohe Belastungen bis 600 Nm ausgelegt

- ▶ Sturdy ratchet handle for diversity applications
- ▶ Prolongable from 150 to 290 or 500 mm
- ▶ Maximum power transmission through leverage
- ▶ Reversible from right to left drive
- ▶ Incl. quick release button
- ▶ Designed for heavy loads up to 600 Nm

**1/2" Teleskop-Umschaltknarre**

1/2" Extension Ratchet Handle,

Art.-Nr./Art.-No. Größe/Size €

4289	1/2" Knarre, 48 Z
------	-------------------

- ▶ Verlängerbar auf 6 Längen:
305, 335, 365, 390, 420, 445 mm
- ▶ Ideale Kraftübertragung durch großen Hebel
- ▶ Umschaltung von Rechts- auf Linkslauf
- ▶ Inkl. Schnelllöseknopf
- ▶ Für hohe Belastungen bis 600 Nm ausgelegt

- ▶ Prolongable to 6 lengths:
305, 335, 365, 390, 420, 445 mm
- ▶ Maximum power transmission through leverage
- ▶ Reversible from right to left drive
- ▶ Incl. quick release button
- ▶ Designed for heavy loads up to 600 Nm

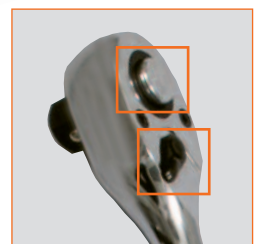

1/4" + 3/8" + 1/2" + 3/4" + 1" Umschaltknarren

1/4" + 3/8" + 1/2" + 3/4" + 1" Ratchet Handle



Art.-Gruppe 120
Article Group 120

PROFESSIONAL PLUS STANDARD

Umschaltknarren mit 2-Komponenten-Griff
Ratchet with 2K-Handle



Art.-Nr./Art.-No.	Größe/Size
5200	1/4" 48 Z, 78 Nm, 140 mm
5200-1	Reparatur Set für 5200
5210	3/8" 48 Z, 245 Nm, 191 mm
5210-1	Reparatur Set für 5210
5220	1/2" 48 Z, 646 Nm, 260 mm
5220-1	Reparatur Set für 5220

PROFESSIONAL PLUS STANDARD

Feinzahn-Umschaltknarren mit 2-Komponenten-Griff
Ratchet with 2K-Handle



Verbesserte Ausführung /
improved Quality

Art.-Nr./Art.-No.	Größe/Size
5201	1/4" 72 Z, 66 Nm, 140 mm
5201-2	Reparatur Set für 5201 (Version ab 2014)
5201-1	Reparatur Set für 5201 (Version bis 2013)
5211	3/8" 72 Z, 208 Nm, 195 mm
5211-2	Reparatur Set für 5211 (Version ab 2014)
5211-1	Reparatur Set für 5211 (Version bis 2013)
5221	1/2" 72 Z, 549 Nm, 250 mm
5221-2	Reparatur Set für 5221 (Version ab 2014)
5221-1	Reparatur Set für 5221 (Version bis 2013)

PROFESSIONAL PLUS STANDARD

Mini-Umschaltknarre
Mini Ratchet Handle



Art.-Nr./Art.-No.	Größe/Size	€
4299	1/4"/105 mm	

PROFESSIONAL PLUS STANDARD

Umsteckknarre für 1/2" Vierkant-Antrieb
Ratchet Handle for 1/2" Drive



Art.-Nr./Art.-No.	Größe/Size	€
4297	1/2" Knarre/ratchet 251 mm	
4297-1	1/2" Vierkant	
4297-2	Stufenschlüssel, 5-stufig 3/8", 29/64", 31/64", 21/32", 53/64"	
4297-3	Stufenschlüssel, 8-stufig 7/8", 27/32", 3/4", 35/64", 1/2", 15/32", 7/16", 3/8", Schraubendreher-Klinge für Schlitzschrauben	

PROFESSIONAL PLUS STANDARD

Umsteckknarren-Set für 1/2" Vierkant-Antrieb, 3-tlg.
Ratchet Handle Set for 1/2" Drive, 3 pieces



Art.-Nr./Art.-No.	Größe/Size	€
4297-10	1/2" Knarre/ratchet 251 mm + Stufenschlüssel, 5-stufig 3/8", 29/64", 31/64", 21/32", 53/64", 1/2" Vierkant	

1/4" + 3/8" + 1/2" + 3/4" + 1" Umschaltknarren

1/4" + 3/8" + 1/2" + 3/4" + 1" Ratchet Handle



Art.-Gruppe 120
Article Group 120

PROFESSIONAL PLUS **STANDARD**

10 mm Bit Ratsche umschaltbar
10 mm Bit Ratchet

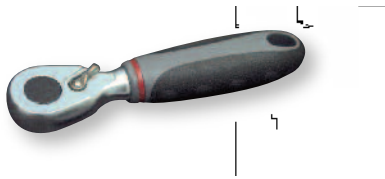

Art.-Nr./Art.-No.	Größe/Size	€
4295	10 mm/137 mm	

PROFESSIONAL PLUS **STANDARD**

1/4" Mini Bit Ratsche umschaltbar
1/4" Mini Bit Ratchet



Art.-Nr./Art.-No.	Größe/Size	€
4294	1/4"/103 mm	

PROFESSIONAL PLUS **STANDARD**

Dual Umschaltknarre für Bits + Nüsse
Dual Ratchet Handle for Bits + Sockets



Art.-Nr./Art.-No.	Größe/Size	€
4290	1/4" / 105 mm	

PROFESSIONAL **PLUS** STANDARD

1/4" Mini Bit Ratsche umschaltbar
1/4" Mini Bit Ratchet

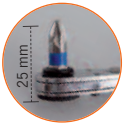

Art.-Nr./Art.-No.	Größe/Size	€
4288	1/4"/88 mm	

PROFESSIONAL **PLUS** STANDARD

1/4" Mini Bit Ratsche umschaltbar
Bit Ratchet



Art.-Nr./Art.-No.	Größe/Size	€
2700	1/4"/98 mm	

1/4" Steckschlüssel und Antriebs Elemente

1/4" Sockets and Accessories



Art.-Gruppe 120
Article Group 120

6-kant, Steckschlüssel-Einsätze, metrisch

Sockets, Hex, Metric



Art.-Nr./Art.-No.	Größe/Size	Länge/Length	€
100035	3,5 mm	25 mm	
100040	4,0 mm	25 mm	
100045	4,5 mm	25 mm	
100050	5,0 mm	25 mm	
100055	5,5 mm	25 mm	
100060	6,0 mm	25 mm	
100070	7,0 mm	25 mm	
100080	8,0 mm	25 mm	
100090	9,0 mm	25 mm	
100100	10,0 mm	25 mm	
100110	11,0 mm	25 mm	
100120	12,0 mm	25 mm	
100130	13,0 mm	25 mm	
100140	14,0 mm	25 mm	

6-kant, extra tiefe Steckschlüssel-Einsätze, metrisch

Deep Sockets, Hex, Metric



Art.-Nr./Art.-No.	Größe/Size	Länge/Length	€
101060	6 mm	50 mm	
101070	7 mm	50 mm	
101080	8 mm	50 mm	
101090	9 mm	50 mm	
101100	10 mm	50 mm	
101110	11 mm	50 mm	
101120	12 mm	50 mm	
101130	13 mm	50 mm	

6-kant, Steckschlüssel-Einsätze, Zoll

Sockets, Hex, Inch



Art.-Nr./Art.-No.	Größe/Size	Länge/Length	€
100503	3/16"	25 mm	
100504	7/32"	25 mm	
100505	1/4"	25 mm	
100506	9/32"	25 mm	
100507	5/16"	25 mm	
100508	11/32"	25 mm	
100509	3/8"	25 mm	
100510	7/16"	25 mm	
100511	1/2"	25 mm	

6-kant, extra tiefe Steckschlüssel-Einsätze, Zoll

Deep Sockets, Hex, Inch



Art.-Nr./Art.-No.	Größe/Size	Länge/Length	€
101503	3/16"	50 mm	
101504	7/32"	50 mm	
101505	1/4"	50 mm	
101506	9/32"	50 mm	
101507	5/16"	50 mm	
101508	11/32"	50 mm	
101509	3/8"	50 mm	
101510	7/16"	50 mm	
101511	1/2"	50 mm	

Schlitz-Bit-Schraubereinsätze

Slotted Bit-Sockets

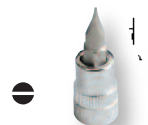

Art.-Nr./Art.-No.	Größe/Size	Länge/Length	€
102040	4,0 mm	36 mm	
102055	5,5 mm	36 mm	
102065	6,5 mm	36 mm	

Phillips-Bit-Schraubereinsätze

Phillips Bit-Sockets



Art.-Nr./Art.-No.	Größe/Size	Länge/Length	€
103001	PH 1	36 mm	
103002	PH 2	36 mm	
103003	PH 3	36 mm	

Pozidriv-Bit-Schraubereinsätze

Pozidriv Bit-Sockets



Art.-Nr./Art.-No.	Größe/Size	Länge/Length	€
104001	PZ 1	36 mm	
104002	PZ 2	36 mm	
104003	PZ 3	36 mm	

TX-Bit-Schraubereinsätze

TX Bit-Sockets



Art.-Nr./Art.-No.	Größe/Size	Länge/Length	€
105008	T8	36 mm	
105009	T9	36 mm	
105010	T10	36 mm	
105015	T15	36 mm	
105020	T20	36 mm	
105025	T25	36 mm	
105027	T27	36 mm	
105030	T30	36 mm	
105040	T40	36 mm	

Innensechskant-Bit-Schraubereinsätze

Hexagon Bit-Sockets



Art.-Nr./Art.-No.	Größe/Size	Länge/Length	€
106002	2 mm	36 mm	
106003	3 mm	36 mm	
106004	4 mm	36 mm	
106005	5 mm	36 mm	
106006	6 mm	36 mm	
106007	7 mm	36 mm	
106008	8 mm	36 mm	

Steckschlüssel-Einsätze TX

TX Sockets



Art.-Nr./Art.-No.	Größe/Size	Länge/Length	€
120004	E4 M3	25 mm	
120005	E5 M4	25 mm	
120006	E6 M5	25 mm	
120007	E7 M6	25 mm	
120008	E8 M6-7	25 mm	
120010	E10 M8	25 mm	
120011	E11 -	25 mm	



Katalog-Seite/Catalogue Page
H 78-79, H 119-122

1/4" Steckschlüssel und Antriebselemente

1/4" Sockets and Accessories



Art.-Gruppe 120
Article Group 120

Verlängerungen/Extension Bars

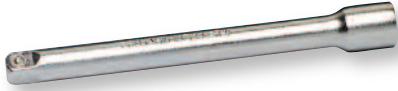

Art.-Nr./Art.-No.	Länge/Length	€
107050	50 mm	
107100	100 mm	
107150	150 mm	

Verlängerungen mit Verriegelung

Locking Extension Bars

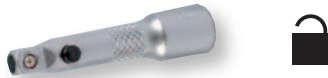

Art.-Nr./Art.-No.	Länge/Length	€
107052	50 mm	
107102	100 mm	

Flexible Verlängerung

Flexible Extension Bar



Art.-Nr./Art.-No.	Länge/Length	€
8605	150 mm	

Gleitgriff/Sliding T-Handle



Art.-Nr./Art.-No.	Länge/Length	€
108100	110 mm	
108200	200 mm	

Adapter

Adapter



Art.-Nr./Art.-No.	Knarre/Ratchet	Nuss/Socket	€
4248	1/4"	3/8"	
4245	3/8"	1/4"	

Kardangeln

Universal Joint



Art.-Nr./Art.-No.	Größe/Size	Länge/Length	€
110000	Kardangeln	35 mm	

Adapter für 1/4" Bits

Adapter for 1/4" Bits



Art.-Nr./Art.-No.	Größe/Size	Länge/Length	€
2760	1/4"	25 mm	

Steckgriff/Spinner Handle



Art.-Nr./Art.-No.	Länge/Length	€
109150	150 mm	

Universal Bit Schraubendreher, magnetisch

Bit Screwdriver, Magnetic



Art.-Nr./Art.-No.	Größe/Size	Länge/Length	€
2128	1/4"	188 mm	

1/4" Stecknuss-Schiene, kurze Nüsse, metrisch

1/4" Socket Rail, Short Sockets, Metric



Art.-Nr./Art.-No.	Größe/Size
4201	6 - 8 - 9 - 10 - 11 - 12 - 13 mm
420000	leere Schiene/empty rail

1/4" Stecknuss-Schiene, tiefe Nüsse, metrisch

1/4" Socket Rail, Deep Sockets, Metric



Art.-Nr./Art.-No.	Größe/Size
4202	6 - 8 - 9 - 10 - 11 - 12 - 13 mm

420000 leere Schiene/empty rail

1/4" Stecknuss-Schiene Innen-TX Nüsse

1/4" Socket Rail, E-TX Sockets



Art.-Nr./Art.-No.	Größe/Size
4203	E4 - E5 - E6 - E7 - E8 - E10 - E11

420000 leere Schiene/empty rail

1/4" Stecknuss-Schiene TX Bit-Nüsse

1/4" Socket Rail, TX Bit Sockets



Art.-Nr./Art.-No.	Größe/Size
4204	TX8 - TX10 - TX15 - TX20 - TX25 - TX27 - TX30

420000 leere Schiene/empty rail

1/4" Umschaltknarren

1/4" Ratchet Handle



Art.-Gruppe 120
Article Group 120

PROFESSIONAL PLUS STANDARD

PROJAHN Umschaltknarre mit säurebeständigem Griff, 36 Zähne
Ratchet Handle, 36 teeth



NEU/NEW

Art.-Nr./Art.-No.	Größe/Size
39014900	1/4" 36 Z, 90 Nm, 147 mm
39014900-1	Reparatur Set für 39014900

PROFESSIONAL PLUS STANDARD



Feinzahn-Umschaltknarre mit 2-Komponenten-Griff, 72 Zähne
Ratchet with 2K-handle, 72 teeth



Art.-Nr./Art.-No.	Größe/Size
5205	1/4" 72 Z, 70 Nm, 140 mm
5205-1	Reparatur Set für 5205

PROFESSIONAL PLUS STANDARD

Umschaltknarre mit 2-Komponenten-Griff, 48 Zähne
Ratchet with 2K-Handle, 48 teeth



Art.-Nr./Art.-No.	Größe/Size
5200	1/4" 48 Z, 78 Nm, 140 mm
5200-1	Reparatur Set für 5200

PROFESSIONAL PLUS STANDARD

U.S. Umschaltknarre, 36 Zähne
Ratchet Handle, U.S. Style, 36 teeth



Art.-Nr./Art.-No.	Größe/Size
4208	1/4" 36 Z, 90 Nm, 147 mm
4200-1	Reparatur Set für 4208

PROFESSIONAL PLUS STANDARD

Feinzahn-Umschaltknarre mit Drehgriff, 60 Zähne
Ratchet with Twist Handle, 60 teeth



Art.-Nr./Art.-No.	Größe/Size	€
5204	1/4" 60 Z, 74 Nm, 182 mm	



Ideal für enge Stellen
Ideal for tight areas

Weitere Informationen auf Seite H 102
Further Information On Page H 102

PROFESSIONAL PLUS STANDARD

Feinzahn-Umschaltknarre mit 2-Komponenten-Griff, 72 Zähne
Ratchet with 2K-Handle, 72 teeth



Verbesserte Ausführung / improved Quality

Art.-Nr./Art.-No.	Größe/Size
5201	1/4" 72 Z, 66 Nm, 140 mm
5201-2	Reparatur Set für 5201 (Version ab 2014)
5201-1	Reparatur Set für 5201 (Version bis 2013, rund)

3/8" Steckschlüssel und Antriebselemente

3/8" Sockets and Accessories



Art.-Gruppe 120
Article Group 120

6-kant, Steckschlüssel-Einsätze, metrisch

Sockets, Hex, Metric



Art.-Nr./Art.-No.	Größe/Size	Länge/Length	€
200060	6 mm	25,5 mm	
200070	7 mm	25,5 mm	
200080	8 mm	25,5 mm	
200090	9 mm	25,5 mm	
200100	10 mm	25,5 mm	
200110	11 mm	25,5 mm	
200120	12 mm	25,5 mm	
200130	13 mm	25,5 mm	
200140	14 mm	27,0 mm	
200150	15 mm	27,0 mm	
200160	16 mm	27,0 mm	
200170	17 mm	27,0 mm	
200180	18 mm	27,0 mm	
200190	19 mm	29,0 mm	
200200	20 mm	29,0 mm	
200210	21 mm	29,0 mm	
200220	22 mm	31,0 mm	
200230	23 mm	31,0 mm	
200240	24 mm	31,0 mm	

6-kant, extra tiefe Steckschlüssel-Einsätze, metrisch

Deep Sockets, Hex, Metric



Art.-Nr./Art.-No.	Größe/Size	Länge/Length	€
201070	7 mm	64 mm	
201080	8 mm	64 mm	
201100	10 mm	64 mm	
201110	11 mm	64 mm	
201120	12 mm	64 mm	
201130	13 mm	64 mm	
201140	14 mm	64 mm	
211214	14 mm	64 mm	

12-kant Zündkerzen-Stecknuss

201150	15 mm	64 mm	
201160	16 mm	61 mm	

Zündkerzen-Stecknuss

201170	17 mm	64 mm	
201180	18 mm	64 mm	
201190	19 mm	64 mm	
201210	21 mm	65 mm	

Zündkerzen-Stecknuss

201220	22 mm	64 mm	
--------	-------	-------	--

Schlitz-Bit-Schraubereinsätze

Slotted Bit-Sockets



Art.-Nr./Art.-No.	Größe/Size	Länge/Length	€
202055	5,5 mm	50 mm	
202065	6,5 mm	50 mm	
202080	8,0 mm	50 mm	
202100	10,0 mm	50 mm	

Phillips-Bit-Schraubereinsätze

Phillips Bit-Sockets



Art.-Nr./Art.-No.	Größe/Size	Länge/Length	€
203001	PH 1	50 mm	
203002	PH 2	50 mm	
203003	PH 3	50 mm	
203004	PH 4	50 mm	

6-kant, Steckschlüssel-Einsätze, Zoll

Sockets, Hex, Inch



Art.-Nr./Art.-No.	Größe/Size	Länge/Length	€
200507	5/16"	25 mm	
200509	3/8"	25 mm	
200510	7/16"	25 mm	
200511	1/2"	25 mm	
200512	9/16"	27 mm	
200513	5/8"	27 mm	
200514	11/16"	27 mm	
200515	3/4"	29 mm	
200516	13/16"	29 mm	
200517	7/8"	31 mm	

6-kant, extra tiefe Steckschlüssel-Einsätze, Zoll

Deep Sockets, Hex, Inch



Art.-Nr./Art.-No.	Größe/Size	Länge/Length	€
201509	3/8"	64 mm	
201510	7/16"	64 mm	
201511	1/2"	64 mm	
201512	9/16"	64 mm	
201513	5/8"	61 mm	

Zündkerzen-Stecknuss

201514	11/16"	64 mm	
201515	3/4"	64 mm	
201516	13/16"	65 mm	

Zündkerzen-Stecknuss

201517	7/8"	64 mm	
201518	5/8"	64 mm	
201519	13/16"	64 mm	

Pozidriv-Bit-Schraubereinsätze

Pozidriv Bit-Sockets



Art.-Nr./Art.-No.	Größe/Size	Länge/Length	€
204001	PZ 1	50 mm	
204002	PZ 2	50 mm	
204003	PZ 3	50 mm	
204004	PZ 4	50 mm	

Xi-on MULTISTECKNUSS

Katalog-Seite / Catalogue Page
H 78-79, H 119-122

3/8" Steckschlüssel und Antriebs Elemente

3/8" Sockets and Accessories



Art.-Gruppe 120
Article Group 120

Innensechskant-Bit-Schraubereinsätze

Hexagon Bit-Sockets



Art.-Nr./Art.-No.	Größe/Size	Länge/Length	€
206003	3 mm	50 mm	
206004	4 mm	50 mm	
206005	5 mm	50 mm	
206006	6 mm	50 mm	
206007	7 mm	50 mm	
206008	8 mm	50 mm	
206010	10 mm	50 mm	

Steckschlüssel-Einsätze TX

TX Sockets



Art.-Nr./Art.-No.	Größe/Size	Länge/Length	€
220004	E4/M3	31 mm	
220005	E5/M4	31 mm	
220006	E6/M5	31 mm	
220007	E7/M6	31 mm	
220008	E8/M6-7	31 mm	
220010	E10/M8	31 mm	
220011	E11/-	31 mm	
220012	E12/M10	31 mm	
220014	E14/M12	31 mm	
220016	E16/M12	31 mm	
220018	E18/M14	31 mm	
220020	E20/M16	31 mm	

Verlängerungen

Extension Bars



Art.-Nr./Art.-No.	Länge/Length	€
207075	75 mm	
207150	150 mm	
207250	250 mm	

TX-Bit-Schraubereinsätze

TX Bit-Sockets



Art.-Nr./Art.-No.	Größe/Size	Länge/Length	€
205010	T10	50 mm	
205015	T15	50 mm	
205020	T20	50 mm	
205025	T25	50 mm	
205027	T27	50 mm	
205030	T30	50 mm	
205040	T40	50 mm	
205045	T45	50 mm	
205050	T50	50 mm	
205055	T55	50 mm	

Adapter

Adapter



Art.-Nr./Art.-No.	Knarre/Ratchet	Nuss/Socket	€
4248	1/4"	3/8"	
4245	3/8"	1/4"	
4249	3/8"	1/2"	
4250	1/2"	3/8"	

Sortiment auf Seite / Set on Page
H 126

Kipp Verlängerungen

Wobble Extension Bars

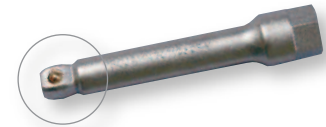

Art.-Nr./Art.-No.	Länge/Length	€
207076	75 mm	
207151	150 mm	

Verlängerungen mit Verriegelung

Locking Extension Bars

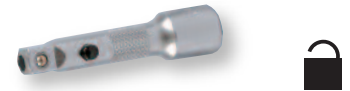

Art.-Nr./Art.-No.	Länge/Length	€
207077	75 mm	
207152	150 mm	

TX-Bit-Schraubereinsätze mit stirnseitiger Bohrung

Tamper TX Bit-Sockets



Art.-Nr./Art.-No.	Größe/Size	Länge/Length	€
205310	T10	50 mm	
205315	T15	50 mm	
205320	T20	50 mm	
205325	T25	50 mm	
205327	T27	50 mm	
205330	T30	50 mm	
205340	T40	50 mm	
205345	T45	50 mm	
205350	T50	50 mm	
205355	T55	50 mm	

Bit-Adapter

Bit Adapter



Art.-Nr./Art.-No.	Größe/Size	Länge/Length	€
2761	3/8" Adapter f. 1/4" Bits	27 mm	

Kardangelenk

Universal Joint



Art.-Nr./Art.-No.	Größe/Size	Länge/Length	€
210000	Kardangelenk	51,5 mm	

Gleitgriff Adapter

Sliding T-Adapter



Art.-Nr./Art.-No.	Größe/Size	€
208001	1/2" (Knarre) x 3/8" (Nuss)	

3/8" Steckschlüssel und Antriebsselemente

3/8" Sockets and Accessories



Art.-Gruppe 120
Article Group 120

PROFESSIONAL PLUS STANDARD

3/8" Durchgangsnüsse, metrisch

3/8" Go-Through Sockets, Metric



Art.-Nr./Art.-No.	Größe/Size	€
4016-10	10 mm	
4016-11	11 mm	
4016-12	12 mm	
4016-13	13 mm	
4016-14	14 mm	
4016-15	15 mm	
4016-16	16 mm	
4016-17	17 mm	
4016-19	19 mm	

PROFESSIONAL PLUS STANDARD

Durchgangsverlängerung

Go-Through Extension Bar



Art.-Nr./Art.-No.	Länge/Length
4016-02	Durchgangsverlängerung 75 mm

PROFESSIONAL PLUS STANDARD

3/8" Stecknusschiene magnetisch

3/8" Magnetic Socket Rail

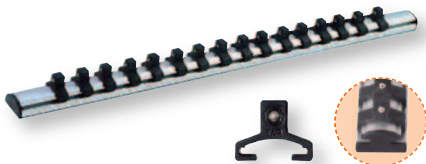

Art.-Nr./Art.-No.	Größe/Size
421001	3/8" Stecknusschiene magnetisch/ 3/8" magnetic socket holder inkl. 14 Halter/incl. 14 clips
421011	3/8" Ersatzhalter, 10 Stück/ 3/8" Clips, 10 pieces

PROFESSIONAL PLUS STANDARD

3/8" Stecknuss-Schiene, kurze Nüsse, metrisch

3/8" Socket Rail, Short Sockets, Metric

12
tlg./pcs.

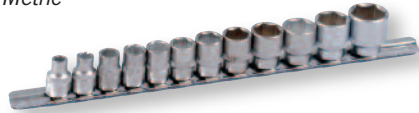

Art.-Nr./Art.-No.	Größe/Size
4211	7 - 8 - 10 - 11 - 12 - 13 - 14 - 15 - 17 - 18 - 19 - 22 mm
421000	leere Schiene/empty rail

PROFESSIONAL PLUS STANDARD

3/8" Stecknuss-Schiene, tiefe Nüsse, metrisch

3/8" Socket Rail, Deep Sockets, Metric

12
tlg./pcs.

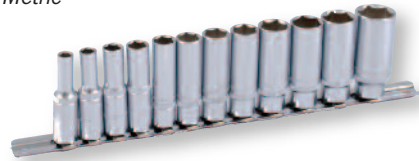

Art.-Nr./Art.-No.	Größe/Size
4212	7 - 8 - 10 - 11 - 12 - 13 - 14 - 15 - 17 - 18 - 19 - 22 mm
421000	leere Schiene/empty rail

PROFESSIONAL PLUS STANDARD

Adapter für 1/4" Nüsse

Adapter for 1/4" Sockets



Art.-Nr./Art.-No.	Größe/Size
4016-03	Adapter für 1/4" Nüsse

PROFESSIONAL PLUS STANDARD

3/8" Stecknuss-Schiene, Innen-TX Nüsse

3/8" Socket Rail, E-TX Sockets

12
tlg./pcs.

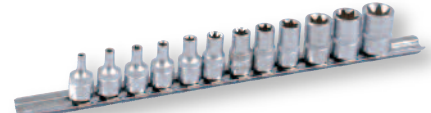

Art.-Nr./Art.-No.	Größe/Size
4213	E4 - E5 - E6 - E7 - E8 - E10 - E11 - E12 - E14 - E16 - E18 - E20
421000	leere Schiene/empty rail

PROFESSIONAL PLUS STANDARD

3/8" Stecknuss-Schiene, Bit-Nüsse kombiniert

3/8" Socket Rail, Bit Sockets

12
tlg./pcs.



Art.-Nr./Art.-No.	Größe/Size
4214	Pozidriv PZ 1 - 2 - 3, Phillips PH 1 - 2 - 3 TX20 - TX27 - TX30 - TX40 - TX45 - TX50 mit Loch
421000	leere Schiene/empty rail

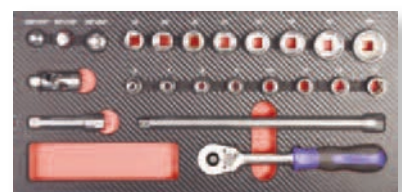

Weitere PROForm-Werkstatteinlagen ab Seite /
More PROForm Inlays for Roller Cabinet from Page H 36

3/8" Umschaltknarren

3/8" Ratchet Handle



Art.-Gruppe 120
Article Group 120

PROFESSIONAL PLUS STANDARD

PROJAHN Umschaltknarre mit säurebeständigem Griff, 38 Zähne

Ratchet Handle, 38 teeth



NEU/NEW

Art.-Nr./Art.-No.	Größe/Size
39038900	3/8" 38 Z, 280 Nm, 195 mm

39038900-1	Reparatur Set für 39038900
------------	----------------------------

PROFESSIONAL PLUS STANDARD

Xi-on MULTISTECKNUS

Feinzahn-Umschaltknarre mit 2-Komponenten-Griff, 72 Zähne

Ratchet with 2K-handle, 72 teeth



Art.-Nr./Art.-No.	Größe/Size
5215	3/8" 72 Z, 225 Nm, 191 mm

5215-1	Reparatur Set für 5215
--------	------------------------

PROFESSIONAL PLUS STANDARD

Umschaltknarre mit 2-Komponenten-Griff, 48 Zähne

Ratchet with 2K-Handle, 48 teeth



Art.-Nr./Art.-No.	Größe/Size
5210	3/8" 48 Z, 245 Nm, 191 mm

5210-1	Reparatur Set für 5210
--------	------------------------

PROFESSIONAL PLUS STANDARD

U.S. Umschaltknarre, 38 Zähne

Ratchet Handle, U.S. Style, 38 teeth



Art.-Nr./Art.-No.	Größe/Size
4218	3/8" 38 Z, 280 Nm, 195 mm

4210-1	Reparatur Set für 4218
--------	------------------------

PROFESSIONAL PLUS STANDARD

Feinzahn-Umschaltknarre mit Drehgriff, 60 Zähne

Ratchet with Twist Handle, 60 teeth



Art.-Nr./Art.-No.	Größe/Size	€
5214	3/8" 60 Z, 242 Nm, 243 mm	



Ideal für enge Stellen
Ideal for tight areas

Weitere Informationen auf
Further Information On

Seite H 102
Page H 102

PROFESSIONAL PLUS STANDARD

Feinzahn-Umschaltknarre mit 2-Komponenten-Griff, 72 Zähne

Ratchet with 2K-Handle, 72 teeth



Verbesserte Ausführung /
improved Quality

Art.-Nr./Art.-No.	Größe/Size
5211	3/8" 72 Z, 208 Nm, 195 mm

5211-2	Reparatur Set für 5211 (Version ab 2014)
--------	--

5211-1	Reparatur Set für 5211 (Version bis 2013, rund)
--------	---

1/2" Steckschlüssel und Antriebselemente

1/2" Sockets and Accessories



Art.-Gruppe 120
Article Group 120

6-kant, Steckschlüssel-Einsätze, metrisch
Sockets, 6-Point, Metric



Art.-Nr./Art.-No.	Größe/Size	Länge/Length	€
300008	8 mm	38 mm	
300009	9 mm	38 mm	
300010	10 mm	38 mm	
300011	11 mm	38 mm	
300012	12 mm	38 mm	
300013	13 mm	38 mm	
300014	14 mm	38 mm	
300015	15 mm	38 mm	
300016	16 mm	38 mm	
300017	17 mm	38 mm	
300018	18 mm	38 mm	
300019	19 mm	38 mm	
300020	20 mm	38 mm	
300021	21 mm	38 mm	
300022	22 mm	41 mm	
300023	23 mm	41 mm	
300024	24 mm	41 mm	
300026	26 mm	44 mm	
300027	27 mm	44 mm	
300028	28 mm	44 mm	
300030	30 mm	44 mm	
300032	32 mm	44 mm	
300034	34 mm	44 mm	
300036	36 mm	50 mm	

12-KANT, Steckschlüssel-Einsätze, metrisch
Sockets, 12-point, Metric



Art.-Nr./Art.-No.	Größe/Size	Länge/Length	€
301208	8 mm	38 mm	
301209	9 mm	38 mm	
301210	10 mm	38 mm	
301211	11 mm	38 mm	
301212	12 mm	38 mm	
301213	13 mm	38 mm	
301214	14 mm	38 mm	
301215	15 mm	38 mm	
301216	16 mm	38 mm	
301217	17 mm	38 mm	
301218	18 mm	38 mm	
301219	19 mm	38 mm	
301220	20 mm	38 mm	
301221	21 mm	38 mm	
301222	22 mm	41 mm	
301223	23 mm	41 mm	
301224	24 mm	41 mm	
301226	26 mm	44 mm	
301227	27 mm	44 mm	
301228	28 mm	44 mm	
301230	30 mm	44 mm	
301232	32 mm	44 mm	
301234	34 mm	44 mm	
301236	36 mm	50 mm	

6-kant, Steckschlüssel-Einsätze, Zoll
Sockets, 6-point, Inch



Art.-Nr./Art.-No.	Größe/Size	Länge/Length	€
300509	3/8"	38 mm	
300510	7/16"	38 mm	
300511	1/2"	38 mm	
300512	9/16"	38 mm	
300513	5/8"	38 mm	
300514	11/16"	38 mm	
300515	3/4"	38 mm	
300516	13/16"	38 mm	
300517	7/8"	41 mm	
300518	15/16"	41 mm	
300519	1"	41 mm	
300520	1 1/16"	44 mm	
300521	1 1/8"	44 mm	
300522	1 1/4"	44 mm	

Xi-on MULTISTECKNUSS

Katalog-Seite / Catalogue Page
H 78-79, H 119-122

6-kant, extra tiefe Steckschlüssel-Einsätze, metrisch

Deep Sockets, 6-point, Metric



Art.-Nr./Art.-No.	Größe/Size	Länge/Length	€
301010	10 mm	77 mm	
301011	11 mm	77 mm	
301012	12 mm	77 mm	
301013	13 mm	77 mm	
301014	14 mm	77 mm	
301015	15 mm	77 mm	
301016	16 mm	65 mm	
Zündkerzen-Stecknuss			
301017	17 mm	77 mm	
301018	18 mm	77 mm	
301019	19 mm	77 mm	
301021	21 mm	65 mm	
Zündkerzen-Stecknuss			
301022	22 mm	77 mm	

12-KANT, extra tiefe Steckschlüssel-Einsätze, metrisch

Deep Sockets, 12-point, Metric



Art.-Nr./Art.-No.	Größe/Size	Länge/Length	€
311214	14 mm	77 mm	
311215	15 mm	77 mm	
311217	17 mm	77 mm	
311219	19 mm	77 mm	

6-kant, extra tiefe Steckschlüssel-Einsätze, Zoll

Deep Sockets, 6-point, Inch



Art.-Nr./Art.-No.	Größe/Size	Länge/Length	€
301511	1/2"	77 mm	
301512	9/16"	77 mm	
301513	5/8"	65 mm	
Zündkerzen-Stecknuss			
301514	11/16"	77 mm	
301515	3/4"	77 mm	
301516	13/16"	65 mm	
Zündkerzen-Stecknuss			
301517	7/8"	77 mm	
301518	15/16"	77 mm	
301519	5/8"	77 mm	
301520	13/16"	77 mm	

1/2" Steckschlüssel und Antriebsselemente

1/2" Sockets and Accessories

Art.-Gruppe 120
Article Group 120

TX-Bit-Schraubereinsätze

TX Bit Sockets



Art.-Nr./Art.-No.	Größe/Size	Länge/Length	€
335010	T10	60 mm	
335015	T15	60 mm	
335020	T20	60 mm	
335025	T25	60 mm	
335027	T27	60 mm	
335030	T30	60 mm	
335040	T40	60 mm	
335045	T45	60 mm	
335050	T50	60 mm	
335055	T55	60 mm	
335060	T60	60 mm	
335070	T70	60 mm	
325110	T10	100 mm	
325115	T15	100 mm	
325120	T20	100 mm	
325125	T25	100 mm	
325127	T27	100 mm	
325130	T30	100 mm	
325140	T40	100 mm	
325145	T45	100 mm	
325150	T50	100 mm	
325155	T55	100 mm	
325160	T60	100 mm	

Innensechskant-Bit-Schraubereinsätze

Hexagon Bit Sockets



Art.-Nr./Art.-No.	Größe/Size	Länge/Length	€
326005	5 mm	60 mm	
326006	6 mm	60 mm	
326007	7 mm	60 mm	
326008	8 mm	60 mm	
326010	10 mm	60 mm	
326012	12 mm	60 mm	
326014	14 mm	60 mm	
326017	17 mm	60 mm	
326019	19 mm	60 mm	
326105	5 mm	100 mm	
326106	6 mm	100 mm	
326107	7 mm	100 mm	
326108	8 mm	100 mm	
326110	10 mm	100 mm	
326112	12 mm	100 mm	
326117	17 mm	100 mm	
326119	19 mm	100 mm	

Steckschlüssel-Einsätze TX

TX Sockets



Art.-Nr./Art.-No.	Größe/Size	Länge/Length	€
320010	E10/M8	40 mm	
320011	E11/-	40 mm	
320012	E12/M10	40 mm	
320014	E14/M12	40 mm	
320016	E16/M12	40 mm	
320018	E18/M14	40 mm	
320020	E20/M16	40 mm	
320022	E22/-	40 mm	
320024	E24/M18-20	40 mm	

TX-Bit-Schraubereinsätze mit stirnseitiger Bohrung

Tamber TX Bit Sockets



Art.-Nr./Art.-No.	Größe/Size	Länge/Length	€
325015	T15	60 mm	
325020	T20	60 mm	
325025	T25	60 mm	
325027	T27	60 mm	
325030	T30	60 mm	
325040	T40	60 mm	
325045	T45	60 mm	
325050	T50	60 mm	
325055	T55	60 mm	
325060	T60	60 mm	

Vielzahn-Bit-Schraubereinsätze

Spline Bit Sockets



Art.-Nr./Art.-No.	Größe/Size	Länge/Length	€
327005	M5	60 mm	
327006	M6	60 mm	
327008	M8	60 mm	
327010	M10	60 mm	
327012	M12	60 mm	
327014	M14	60 mm	
327016	M16	60 mm	
327105	M5	100 mm	
327106	M6	100 mm	
327108	M8	100 mm	
327110	M10	100 mm	
327112	M12	100 mm	
327114	M14	100 mm	
327116	M16	100 mm	

Tiefe Steckschlüssel-Einsätze TX

Deep TX Sockets



Art.-Nr./Art.-No.	Größe/Size	Länge/Length	€
321010	E10	77 mm	
321012	E12	77 mm	
321014	E14	77 mm	
321016	E16	77 mm	
321018	E18	77 mm	
321020	E20	77 mm	
321022	E22	77 mm	
321024	E24	77 mm	

1/2" Steckschlüssel und Antriebselemente

1/2" Sockets and Accessories



Art.-Gruppe 120
Article Group 120

Verlängerungen

Extension Bars

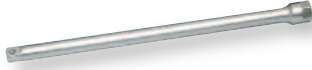

Art.-Nr./Art.-No.	Länge/Length	€
307125	125 mm	
307250	250 mm	

Kipp Verlängerungen

Wobble Extension Bars



Art.-Nr./Art.-No.	Länge/Length	€
307126	125 mm	
307251	250 mm	

Verlängerungen mit Verriegelung

Locking Extension Bars



Art.-Nr./Art.-No.	Länge/Length	€
307127	125 mm	
307252	250 mm	

Gleitgriff

Sliding T-Handle



Art.-Nr./Art.-No.	Länge/Length	€
308300	300 mm	

Gleitgriff Adapter

Sliding T-Adapter



Art.-Nr./Art.-No.	Größe/Size
308001	T Gleitgriff Adapter 1/2" x 1/2"

Kardangeln

Universal Joint



Art.-Nr./Art.-No.	Größe/Size	Länge/Length
310000	Kardangeln	67 mm

Bit Adapter

Bit Adapter



Art.-Nr./Art.-No.	Größe/Size	Länge/Length
311516	1/2" Adapter f. 5/16" Bits	38 mm

Adapter

Adapter



Art.-Nr./Art.-No.	Knarre/Ratchet	Nuss/Socket	€
4249	3/8"	1/2"	
4250	1/2"	3/8"	
4246	1/2"	3/4"	
4251	3/4"	1/2"	

Sortiment auf Seite /Set on Page
H 126

1/2" Stecknuss-Schiene, kurze Nüsse, metrisch

1/2" Socket Rail, Short Sockets, Metric

10
tlg./pcs.

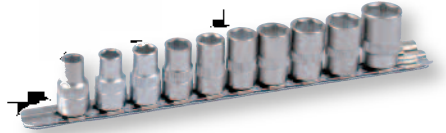

Art.-Nr./Art.-No.	Größe/Size
4221	10 - 11 - 12 - 13 - 14 - 15 - 17 - 18 - 19 - 22 mm

422000	leere Schiene/empty rail
--------	--------------------------

1/2" Stecknuss-Schiene, tiefe Nüsse, metrisch

1/2" Socket Rail, Deep Sockets, Metric

10
tlg./pcs.



Art.-Nr./Art.-No.	Größe/Size
4222	10 - 11 - 12 - 13 - 14 - 15 - 17 - 18 - 19 - 22 mm

422000	leere Schiene/empty rail
--------	--------------------------

1/2" Stecknuss-Schiene, Innen-TX Nüsse

1/2" Socket Rail, E-TX Sockets

7
tlg./pcs.



Art.-Nr./Art.-No.	Größe/Size
4223	E12 - E14 - E16 - E18 - E20 - E22 - E24

422000	leere Schiene/empty rail
--------	--------------------------

1/2" Steckschlüssel und Antriebselemente

1/2" Sockets and Accessories



Art.-Gruppe 120
Article Group 120

1/2" Stecknuss-Schiene, TX Bit-Nüsse, 60 mm

1/2" Socket Rail, TX Bit Sockets

10
tlg./pcs.



Art.-Nr./Art.-No. Größe/Size

4236 TX10 - TX15 - TX20 - TX25 - TX27 - TX30 - TX40 - TX45 - TX50 - TX55

422000 leere Schiene/empty rail

1/2" Stecknuss-Schiene, Vielzahn Bit-Nüsse, 60 + 100 mm

1/2" Socket Rail, Spline Bit Sockets

11
tlg./pcs.

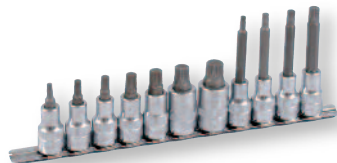

Art.-Nr./Art.-No. Größe/Size

4233 60 mm: M5 - M6 - M8 - M10 - M12 - M14 - M16
100 mm: M5 - M6 - M8 - M10

422000 leere Schiene/empty rail

1/2" Stecknuss-Schiene, Inbus + Vielzahn Bit-Nüsse, 60 mm

1/2" Socket Rail, Hex + Spline Bit Sockets

11
tlg./pcs.



Art.-Nr./Art.-No. Größe/Size

4235 5 - 6 - 7 - 8 - 10 - 12 mm
M5 - M6 - M8 - M10 - M12

422000 leere Schiene/empty rail

1/2" Stecknuss-Schiene, TX Bit-Nüsse, 100 mm

1/2" Socket Rail, TX Bit Sockets

11
tlg./pcs.



Art.-Nr./Art.-No. Größe/Size

4231 TX10 - TX15 - TX20 - TX25 - TX27 - TX30 - TX40 - TX45 - TX50 - TX55 - TX60

422000 leere Schiene/empty rail

1/2" Stecknuss-Schiene, Inbus Bit-Nüsse, 60 + 100 mm

1/2" Socket Rail, Hex Bit Sockets

11
tlg./pcs.

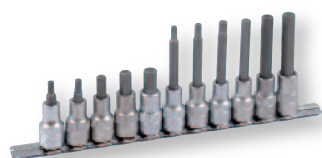

Art.-Nr./Art.-No. Größe/Size

4234 60 mm: 5 - 6 - 8 - 10 - 12 mm
100 mm: 5 - 6 - 7 - 8 - 10 - 12 mm

422000 leere Schiene/empty rail

1/2" Stecknuss-Schiene, Inbus + Vielzahn Bit-Nüsse, 100 mm

1/2" Socket Rail, Hex + Spline Bit Sockets

11
tlg./pcs.

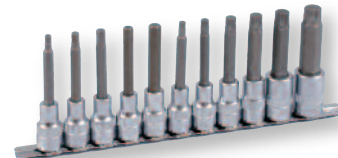

Art.-Nr./Art.-No. Größe/Size

4232 5 - 6 - 7 - 8 - 10 mm
M6 - M8 - M10 - M12 - M14 - M16

422000 leere Schiene/empty rail

1/2" Stecknuss-Schiene, TX Bit-Nüsse mit Loch, 60 mm

1/2" Socket Rail, Tamper TX Bit Sockets

10
tlg./pcs.



Art.-Nr./Art.-No. Größe/Size

4224 TX15 - TX20 - TX25 - TX27 - TX30 - TX40 - TX45 - TX50 - TX55 - TX60

422000 leere Schiene/empty rail

PROFESSIONAL PLUS STANDARD

1/2" Stecknuss-Schiene magnetisch

1/2" Magnetic Socket Rail

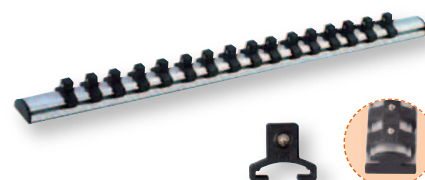

Art.-Nr./Art.-No. Größe/Size

422001 1/2" Stecknuss-Schiene magnetisch/
1/2" magnetic socket holder
inkl. 14 Halter/incl. 14 clips

422011 1/2" Ersatzhalter, 10 Stück/
1/2" Clips, 10 pieces

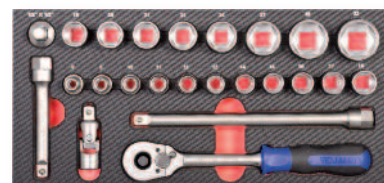

Weitere PROForm-Werkstatteinlagen ab Seite /
More PROForm Inlays for Roller Cabinet from Page H 36

1/2" Umschaltknarren

1/2" Ratchet Handle



Art.-Gruppe 120
Article Group 120

PROFESSIONAL PLUS STANDARD

PROJAHN Umschaltknarre mit säurebeständigem Griff, 40 Zähne
Ratchet Handle, 40 teeth



NEU/NEW

Art.-Nr./Art.-No.	Größe/Size
39012900	1/2" 40 Z, 640 Nm, 265 mm
39012900-1	Reparatur Set für 39012900

PROFESSIONAL PLUS STANDARD

MULTISTECKNUS
Xi-on
Feinzahn-Umschaltknarre mit 2-Komponenten-Griff, 60 Zähne
Ratchet with 2K-handle, 60 teeth



Art.-Nr./Art.-No.	Größe/Size
5225	1/2" 60 Z, 600 Nm, 260 mm
5225-1	Reparatur Set für 5225

PROFESSIONAL PLUS STANDARD

Umschaltknarre mit 2-Komponenten-Griff, 48 Zähne
Ratchet with 2K-Handle, 48 teeth



Art.-Nr./Art.-No.	Größe/Size
5220	1/2" 48 Z, 646 Nm, 260 mm
5220-1	Reparatur Set für 5220

PROFESSIONAL PLUS STANDARD

U.S. Umschaltknarre, 40 Zähne
Ratchet Handle, U.S. Style, 40 teeth



Art.-Nr./Art.-No.	Größe/Size
4228	1/2" 40 Z, 640 Nm, 265 mm
4220-1	Reparatur Set für 4228

PROFESSIONAL PLUS STANDARD

Feinzahn-Umschaltknarre mit Drehgriff, 60 Zähne
Ratchet with Twist Handle, 60 teeth



Art.-Nr./Art.-No.	Größe/Size	€
5224	1/2" 60 Z, 614 Nm, 292 mm	



Ideal für enge Stellen
Ideal for tight areas

Weitere Informationen auf Seite H 102
Further Information On Page H 102

PROFESSIONAL PLUS STANDARD

Feinzahn-Umschaltknarre mit 2-Komponenten-Griff, 72 Zähne
Ratchet with 2K-Handle, 72 teeth



Verbesserte Ausführung /
improved Quality

Art.-Nr./Art.-No.	Größe/Size
5221	1/2" 72 Z, 549 Nm, 250 mm
5221-2	Reparatur Set für 5221 (Version ab 2014)
5221-1	Reparatur-Set für 5221 (Version bis 2013, rund)

3/4" Steckschlüssel und Antriebselemente

3/4" Sockets and Accessories



Art.-Gruppe 120
Article Group 120

6-kant, Steckschlüssel-Einsätze, metrisch

Sockets, 6-point, Metric



Art.-Nr./Art.-No.	Größe/Size	Länge/Length	€
400190	19 mm	50,5 mm	
400210	21 mm	50,5 mm	
400220	22 mm	50,5 mm	
400230	23 mm	50,5 mm	
400240	24 mm	50,5 mm	
400260	26 mm	50,5 mm	
400270	27 mm	50,5 mm	
400290	29 mm	52,0 mm	
400300	30 mm	52,0 mm	
400320	32 mm	55,0 mm	
400350	35 mm	58,0 mm	
400360	36 mm	58,0 mm	
400380	38 mm	60,0 mm	
400410	41 mm	64,0 mm	
400460	46 mm	67,0 mm	
400500	50 mm	72,0 mm	

Verlängerungen

Extension Bars



Art.-Nr./Art.-No.	Länge/Length	€
407100	100 mm	
407200	200 mm	
407400	400 mm	

Adapter

Adapter



Art.-Nr./Art.-No.	Knarre/Ratchet	Nuss/Socket	€
4246	1/2" 49 mm	3/4"	
4251	3/4" 53 mm	1/2"	
4247	3/4" 62 mm	1"	
4252	1" 73 mm	3/4"	

Sortiment auf Seite /Set on Page
H 126

3/4" Umschaltknarre

Ratchet Handle

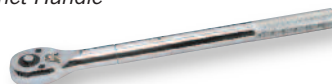

Art.-Nr./Art.-No.	Größe/Size	€
400001	3/4"	
400001-1	Reparatur Set für 400001	

T-Gleitgriff

Sliding T-Handle



Art.-Nr./Art.-No.	Länge/Length	€
408000	450 mm	

1" Steckschlüssel und Antriebselemente

1" Sockets and Accessories



Art.-Gruppe 120
Article Group 120

Steckschlüssel-Einsätze, metrisch

Sockets, Metric



Art.-Nr./Art.-No.	Größe/Size	Länge/Length	€
500360	36 mm	65 mm	
500380	38 mm	65 mm	
500410	41 mm	70 mm	
500460	46 mm	75 mm	
500500	50 mm	75 mm	
500540	54 mm	79 mm	
500550	55 mm	80 mm	
500580	58 mm	80 mm	
500600	60 mm	84 mm	
500630	63 mm	87 mm	
500650	65 mm	87 mm	
500670	67 mm	89 mm	
500700	70 mm	92 mm	
500710	71 mm	92 mm	
500750	75 mm	96 mm	
500770	77 mm	103 mm	
500800	80 mm	105 mm	

Verlängerungen

Extension Bars



Art.-Nr./Art.-No.	Länge/Length	€
507200	200 mm	
507400	400 mm	

Adapter

Adapter



Art.-Nr./Art.-No.	Knarre/Ratchet	Nuss/Socket	€
4247	3/4" 62 mm	1"	
4252	1" 73 mm	3/4"	

Gleitgriff Adapter

Sliding T-Adapter



Art.-Nr./Art.-No.	Größe/Size	€
508000	1" x 1"	

1" Umschaltknarrenkopf

Ratchet Handle Head



Art.-Nr./Art.-No.	Größe/Size	€
500000	1"	

Universalgriff

Universal Handle

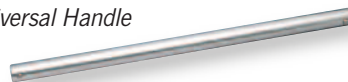

Art.-Nr./Art.-No.	Länge/Length	€
508560	560 mm	

Kardangeln

Universal Joint



Art.-Nr./Art.-No.	Größe/Size	Länge/Length	€
510000	Kardangeln	140 mm	

Xi-on MULTI-Steckschlüssel

Xi-on MULTI-Sockets

Art.-Gruppe 110
Article Group 110

Xi-on

MULTISTECKNUSS / MULTI SOCKET

Wenn nichts mehr geht, greift Xi-on.

- ▶ Extrem innovativ: Revolutionäres Xi-on Spezialprofil öffnet bis zu 85% abgerundete Schrauben und Muttern
- ▶ Greift auch da noch, wo herkömmliche Stecknüsse versagen
- ▶ Öffnet alle gängigen metrischen 6-kant-, 12-kant- und Vielzahn-Muttern & -Schrauben
- ▶ Empfohlen von der Redaktion »Technik und Motor« der FAZ

If Nothing Works, Xi-on Helps.

- ▶ Extremely innovative: Revolutionary Xi-on special construction opens up to 85% rounded screws and screw nuts
- ▶ Easy working where even conventional sockets fail
- ▶ Opens all standard metric hex, double hex, spline screw nuts and screws
- ▶ Recommended by »Technik und Motor« of FAZ (established reputed Frankfurt Newspaper, Germany)



Selbst stark beschädigte Schrauben können mit Xi-on geöffnet werden.

Even heavily damaged screws can be opened with Xi-on.

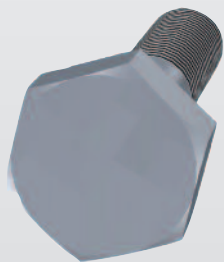

6-kant / Hex



85% abgerundet / rounded

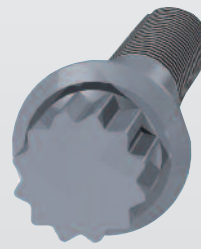

12-kant / Double Hex

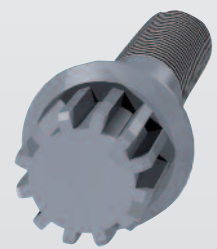

Vielzahn / Spline

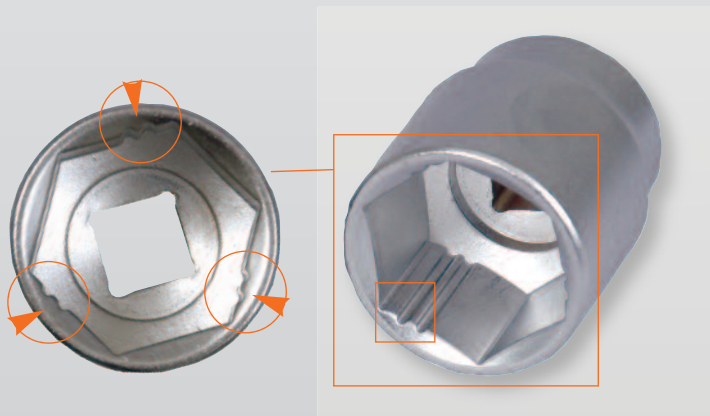

1/4" Xi-on Steckschlüssel und Antriebselemente

1/4" Xi-on Sockets and Accessories



Art.-Gruppe 120
Article Group 120

Xi-on 6-kant Steckschlüssel-Einsätze, metrisch

Xi-on Sockets, Hex, Metric



Art.-Nr./Art.-No.	Größe/Size	Länge/Length	€
411004	4,0 mm	25 mm	
411045	4,5 mm	25 mm	
411005	5,0 mm	25 mm	
411055	5,5 mm	25 mm	
411006	6,0 mm	25 mm	
411007	7,0 mm	25 mm	
411008	8,0 mm	25 mm	
411009	9,0 mm	25 mm	
411010	10,0 mm	25 mm	
411011	11,0 mm	25 mm	
411012	12,0 mm	25 mm	
411013	13,0 mm	25 mm	

1/4" Xi-on Stecknuss-Schiene 6-kant

1/4" Xi-on Socket Rail, Hex

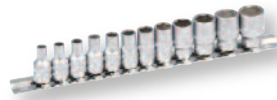

12
tig./pcs.

Art.-Nr./Art.-No.	Größe/Size
4109	Ø 4 - 4,5 - 5 - 5,5 - 6 - 7 - 8 - 9 - 10 - 11 - 12 - 13 mm
423000	leere Schiene/empty rail

Xi-on Kardangelen

Xi-on Universal Joint



Art.-Nr./Art.-No.	Länge/Length	€
411100	41 mm	

Xi-on Gleitgriff-Adapter

Xi-on Sliding T-Adapter



Art.-Nr./Art.-No.	Beschr./Descr.	€
411438	3/8" x 1/4" mm	

Xi-on Phillips-Bit Schraubereinsätze, Xi-on Phillips Bit-Sockets



Art.-Nr./Art.-No.	Größe/Size	Länge/Length	€
411301	PH1	32 mm	
411302	PH2	32 mm	

Xi-on Innensechskant-Bit-Schraubereinsätze

Hexagon Bit-Sockets



Art.-Nr./Art.-No.	Größe/Size	Länge/Length	€
411603	3,0 mm	32 mm	
411604	4,0 mm	32 mm	
411605	5,0 mm	32 mm	
411606	6,0 mm	32 mm	
411608	8,0 mm	32 mm	
411610	10,0 mm	32 mm	

Xi-on Schlitz-Bit Schraubereinsätze, Xi-on Slotted Bit-Sockets



Art.-Nr./Art.-No.	Größe/Size	Länge/Length	€
411255	5,5 mm	32 mm	
411207	7,0 mm	32 mm	

1/4" Stecknuss-Schiene magnetisch

1/4" Magnetic Socket Rail



Art.-Nr./Art.-No.	Größe/Size
420001	1/4" Stecknuss-Schiene magnetisch/ 1/4" magnetic socket holder inkl. 14 Halter/incl. 14 clips
420011	1/4" Ersatzhalter, 10 Stück/ 1/4" Clips, 10 pieces

Xi-on Gleitgriff/Xi-on Sliding T-Handle



Art.-Nr./Art.-No.	Länge/Length	€
411081	150 mm	

Xi-on Steckgriff/Xi-on Spinner Handle



Art.-Nr./Art.-No.	Länge/Length	€
411915	150 mm	

Xi-on Verlängerung/Xi-on Extension Bars

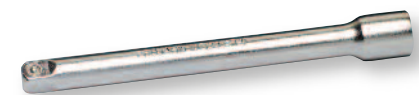

Art.-Nr./Art.-No.	Länge/Length	€
411705	50 mm	
411715	150 mm	



Feinzahn-Umschaltknarre mit 2-Komponenten-Griff, 72 Zahn

Ratchet with 2K-handle, 72 teeth



Art.-Nr./Art.-No.	Größe/Size
5205	1/4" 72 Z, 70 Nm, 140 mm
5205-1	Reparatur Set für 5205

3/8" Xi-on Steckschlüssel und Antriebselemente

3/8" Xi-on Sockets and Accessories



Art.-Gruppe 120
Article Group 120

Xi-on 6-kant Steckschlüssel-Einsätze, metrisch

Xi-on Sockets, Hex, Metric



Art.-Nr./Art.-No.	Größe/Size	Länge/Length	€
412008	8,0 mm	30 mm	
412010	10,0 mm	30 mm	
412011	11,0 mm	30 mm	
412012	12,0 mm	30 mm	
412013	13,0 mm	30 mm	
412014	14,0 mm	30 mm	
412015	15,0 mm	30 mm	
412016	16,0 mm	30 mm	
412017	17,0 mm	30 mm	
412018	18,0 mm	30 mm	
412019	19,0 mm	30 mm	

Xi-on Verlängerung

Xi-on Extension Bars

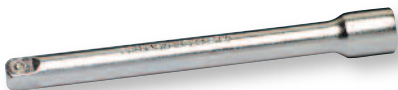

Art.-Nr./Art.-No.	Länge/Length	€
412707	75 mm	
412715	150 mm	

Sortimente auf Seite /Sets on Page
H 78 - H 79



Weitere PROForm-Werkstatteinlagen ab Seite /
More PROForm Inlays for Roller Cabinet from Page H 36

3/8" Xi-on Stecknuss-Schiene 6-kant

3/8" Xi-on Socket Rail, Hex

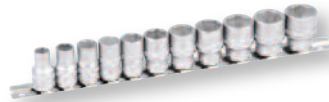

Art.-Nr./Art.-No.	Größe/Size
4119	Ø 8 - 10 - 11 - 12 - 13 - 14 - 15 16 - 17 - 18 - 19 mm
423000	leere Schiene/empty rail

Xi-on Kardangelenk

Xi-on Universal Joint



Art.-Nr./Art.-No.	Länge/Length	€
412100	57 mm	

3/8" Stecknuss-Schiene magnetisch

3/8" Magnetic Socket Rail

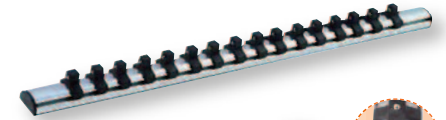

Art.-Nr./Art.-No.	Größe/Size
421001	3/8" Stecknuss-Schiene magnetisch/ 3/8" magnetic socket holder inkl. 14 Halter/incl. 14 clips
421011	3/8" Ersatzhalter, 10 Stück/ 3/8" clips, 10 pieces

Xi-on Gleitgriff

Xi-on Sliding T-Handle



Art.-Nr./Art.-No.	Länge/Length	€
412920	200 mm	



Feinzahn-Umschaltknarre mit 2-Komponenten-Griff, 72 Zahn

Ratchet with 2K-handle, 72 teeth



Art.-Nr./Art.-No.	Größe/Size
5215	3/8" 72 Z, 225 Nm, 191 mm
5215-1	Reparatur Set für 5215

1/2" Xi-on Steckschlüssel und Antriebselemente

1/2" Xi-on Sockets and Accessories

1/2"

MULTISTECKNUSS
Xi-on

Art.-Gruppe 120
Article Group 120

Xi-on 6-kant Steckschlüssel-Einsätze, metrisch

Xi-on Sockets, Hex, Metric,



Art.-Nr./Art.-No.	Größe/Size	Länge/Length	€
413010	10,0 mm	38 mm	
413011	11,0 mm	38 mm	
413012	12,0 mm	38 mm	
413013	13,0 mm	38 mm	
413014	14,0 mm	38 mm	
413015	15,0 mm	38 mm	
413016	16,0 mm	38 mm	
413017	17,0 mm	38 mm	
413018	18,0 mm	38 mm	
413019	19,0 mm	38 mm	
413021	21,0 mm	38 mm	
413022	22,0 mm	38 mm	
413024	24,0 mm	38 mm	
413027	27,0 mm	45 mm	
413030	30,0 mm	45 mm	
413032	32,0 mm	45 mm	

1/2" Xi-on Stecknuss-Schiene 6-kant

1/2" Xi-on Socket Rail, Hex

10
tfg./pcs.

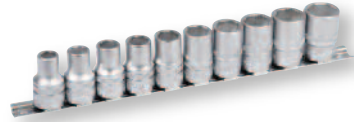

Art.-Nr./Art.-No.	Größe/Size
4129	Ø 10 - 11 - 12 - 13 - 14 - 15 - 16 - 17 - 18 - 19 mm

422000 leere Schiene/empty rail

Xi-on Kardangelen

Xi-on Universal Joint



Art.-Nr./Art.-No.	Länge/Length	€
413100	73 mm	

1/2" Stecknusschiene magnetisch

1/2" Magnetic Socket Rail

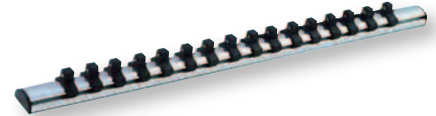

Art.-Nr./Art.-No.	Größe/Size
422001	1/2" Stecknusschiene magnetisch/ 1/2" magnetic socket holder inkl. 14 Halter/incl. 14 clips

422011 1/2" Ersatzhalter, 10 Stück/
1/2" Clips, 10 pieces

Xi-on Gleitgriff-Adapter

Xi-on Sliding T-Adapter



Art.-Nr./Art.-No.	Beschr./Descr.	€
413812	3/8" x 1/2"	

Xi-on 6-kant Zündkerzen-Stecknuss, metrisch

Xi-on Spark Plug Sockets, Hex, Metric



Art.-Nr./Art.-No.	Größe/Size	Länge/Length	€
413116	16,0 mm	65 mm	
413121	21,0 mm	65 mm	

Xi-on Verlängerung

Xi-on Extension Bar

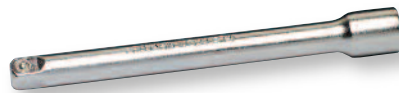

Art.-Nr./Art.-No.	Länge/Length	€
413712	125 mm	
413725	250 mm	

MULTISTECKNUSS
Xi-on

Feinzahn-Umschaltknarre mit 2-Komponenten-Griff, 60 Zahn

Ratchet with 2K-handle, 60 teeth



Art.-Nr./Art.-No.	Größe/Size
5225	1/2" 60 Z, 600 Nm, 260 mm
5225-1	Reparatur Set für 5225



Weitere PROForm-Werkstatteinlagen ab Seite /
More PROForm Inlays for Roller Cabinet from Page H 36

Sortimente auf Seite /Sets on Page
H 78 - H 79

Drehmomentschlüssel

Torque Wrenches



Drehmomentschlüssel TORQUE-PROFI PLUS

Torque Wrenches TORQUE PROFI PLUS

NEU/NEW

Art.-Gruppe 121
Article Group 121

Auslöserichtung im und gegen den Uhrzeigersinn /
Operative direction clockwise and anti-clockwise

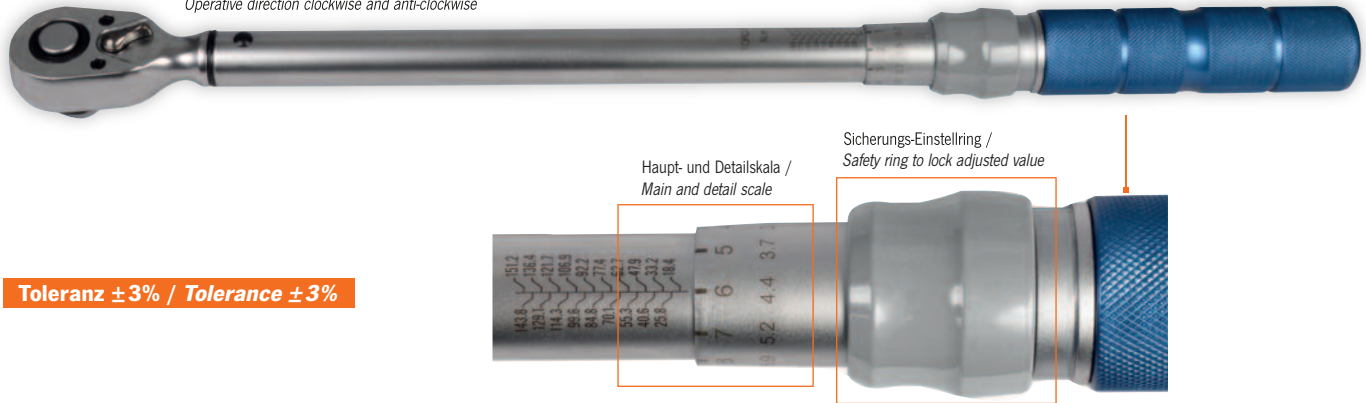

Toleranz ± 3% / Tolerance ± 3%

TORQUE-PROFI PLUS

- ▶ **Mechanischer Zweigweg-Drehmomentschlüssel**
- ▶ **Leichte und sichere Einstellung des Drehmoments**
- ▶ **Sicherungsring zum Sperren der Einstellung**
- ▶ **Hohe Anwendungssicherheit**
 - Hör- und fühlbare automatische Kurzwegauslösung
 - Rutschhemmender, ergonomischer Handgriff
- ▶ **Extrem robust und langlebig**
- ▶ **Technische Daten:**
 - Typ mechanisch, Drehmomentbereich: 5 – 340 Nm
 - Auslöserichtung:
Zweigweg, im und gegen Uhrzeigersinn
 - Mit Schnelllöseknopf und Richtungsumschalter
 - Inklusive Kalibrierungszertifikat nach DIN EN ISO 6789:2003
- ▶ **Achtung:**
 - Drehmomentschlüssel nach Gebrauch auf den kleinsten Wert zurückstellen!
 - Drehmomentschlüssel sollen je nach Gebrauch einmal jährlich neu kalibriert werden. Nutzen Sie hierzu unseren Kalibrierungsservice auf Seite H 126.

TORQUE-PROFI PLUS

- ▶ *Mechanically dual way torque wrench*
- ▶ *Easy and safe adjustment of the torque*
- ▶ *Safety ring to lock the adjustable value*
- ▶ *High application safety*
 - *Audible and tactile automatic short path release*
 - *Ergonomic non-slip handle*
- ▶ *Extrem sturdy and durable*
- ▶ **Technically data:**
 - Type mechanically, torque range: 5 – 340 Nm
 - Operative direction:
Dual way, clockwise and anti-clockwise
 - With quick release button and direction lever
 - Incl. certificate of calibration DIN EN ISO 6789:2003
- ▶ **Attention:**
 - After working please turn back to the smallest value of the wrench!
 - Torque wrenches have to be, depending on use, calibrated once a year. Simply use our calibration service on page H 126.

TORQUE-PROFI PLUS mechanischer Zweigweg-Drehmomentschlüssel

TORQUE-PROFI PLUS

mechanically dual way torque wrench



NEU/NEW

Toleranz ± 3% / Tolerance ± 3%

Art.-Nr./Art.-No.	Antrieb/Drive	Bereich/Array	Länge/Length	€
394270	1/4"	5 - 25 Nm	245 mm	
394241-1	Reperatur-Set für 394270			
394271	3/8"	20 - 100 Nm	410 mm	
394242-1	Reperatur-Set für 394271			
394272	1/2"	40 - 200 Nm	520 mm	
394240-1	Reperatur-Set für 394272			
394273	1/2"	60 - 340 Nm	610 mm	
394243-1	Reperatur-Set für 394273			

Drehmomentschlüssel TORQUE-PROFI

Torque Wrenches TORQUE PROF I

NEU/NEW

Art.-Gruppe 121
Article Group 121



Toleranz $\pm 4\%$ / Tolerance $\pm 4\%$

TORQUE-PROFI

- ▶ **Mechanischer Einweg-Drehmomentschlüssel (Uhrzeigersinn)**
- ▶ **Erleichterte Ableseskala durch farbig hinterlegte Skala**
- ▶ **Leichtgängiger Einstellring am Griff**
- ▶ **Sicherungsknopf zum Sperren des Einstellrings**
- ▶ **Hohe Anwendungssicherheit**
 - Hör- und fühlbare automatische Kurzwegauslösung
 - Rutschhemmender, ergonomischer Handgriff
- ▶ **Extrem robust und langlebig**
- ▶ **Technische Daten:**
 - **Typ mechanisch, Drehmomentbereich: 5 – 340 Nm**
 - **Auslöserichtung: Einweg, im Uhrzeigersinn**
 - **Mit Schnelllöseknopf und Richtungsumschalter**
 - **Inklusive Kalibrierungszertifikat nach DIN EN ISO 6789:2003**
- ▶ **Achtung:**
 - **Drehmomentschlüssel nach Gebrauch auf den kleinsten Wert zurückstellen!**
 - **Drehmomentschlüssel sollen je nach Gebrauch einmal jährlich neu kalibriert werden. Nutzen Sie hierzu unseren Kalibrierungsservice auf Seite H 126.**

TORQUE-PROFI

- ▶ *Mechanically one-way torque wrench (clockwise rotation)*
- ▶ *Easy readability due to colored measured value display*
- ▶ *Smooth-running adjustment ring at the handle*
- ▶ *Safety button to lock the adjustment ring*
- ▶ *High application safety*
 - *Audible and tactile automatic short path release*
 - *Ergonomic non-slip handle*
- ▶ *Extrem sturdy and durable*
- ▶ **Technically data:**
 - *Type mechanically, torque range: 5 – 340 Nm*
 - *Operative direction: One-way, clockwise rotation*
 - *With quick release button and direction lever*
 - *Incl. certificate of calibration DIN EN ISO 6789:2003*
- ▶ **Attention:**
 - *After working please turn back to the smallest value of the wrench!*
 - *Torque wrenches have to be, depending on use, calibrated once a year. Simply use our calibration service on page H 126.*

NEU/NEW

TORQUE-PROFI

mechanischer Einweg-Drehmomentschlüssel

TORQUE-PROFI

mechanically dual way torque wrench



Toleranz $\pm 4\%$ / Tolerance $\pm 4\%$

Art.-Nr./Art.-No.	Antrieb/Drive	Bereich/Array	Länge/Length	€
394241	1/4"	5 - 25 Nm	245 mm	
394241-1	Reperatur-Set für 394241			
394242	3/8"	20 - 100 Nm	410 mm	
394242-1	Reperatur-Set für 394242			
394240	1/2"	40 - 200 Nm	520 mm	
394240-1	Reperatur-Set für 394240			
394243	1/2"	60 - 340 Nm	610 mm	
394243-1	Reperatur-Set für 394243			

1/2" Drehmomentschlüssel-Set TORQUE-PROFI

1/2" Torque Wrenche Set TORQUE PROFI

1/2"

NEU/NEW

Art.-Gruppe 121
Article Group 121

394260 **NEU/NEW**

1/2" Drehmomentschlüssel-Set, 11-teilig Drehmomentschlüssel mit den gebräuchlichsten Nüssen für den universellen Einsatz

1/2" Torque Wrench Set, 11 pieces with Sockets

Inhalt/Contents:

- 1/2" Stecknüsse/Sockets 17 - 19 - 21 - 22 - 24 - 27 mm
- 1/2" Bit-Stecknüsse Innensechskant/Ex Bit Sockets 6 - 8 - 10 - 12 mm
- 1/2" Drehmomentschlüssel TORQUE-PROFI 40 - 220 Nm

Achtung:

- Drehmomentschlüssel nach Gebrauch auf den kleinsten Wert zurückstellen!
- Drehmomentschlüssel sollen je nach Gebrauch einmal jährlich neu kalibriert werden. Nutzen sie hierzu unseren Kalibrierungsservice auf dieser Seite.



Attention:

- After working please turn back to the smallest value of the wrench!
- Torque wrenches have to be, depending on use, calibrated once a year. Simply use our calibration service on this page.

Art.-Nr./Art.-No.	Antrieb/Drive	Bereich/Array	€
394260	1/2"	40 - 200 Nm	
394240-1	Reperatur-Set für 394260		

Drehmomentschlüssel sollen, je nach Gebrauch, einmal jährlich neu kalibriert werden. Nutzen Sie hierzu unseren Kalibrierungsservice. Wenden Sie sich dazu an unseren Kundenservice unter +49 (0) 60 74 / 69 666 - 66 oder verkauf@projahn.de. Für jede Kalibrierung eines Drehmomentschlüssels berechnen wir 39,90 €.

Torque Wrenches should be, depending on use, calibrated once a year. Simply use our calibration service. Please contact our costumer service at +49 (0) 60 74 / 69 666 - 66 or verkauf@projahn.de. For every calibration of a torque wrench we will charge 39,90 €.

Adapter Satz

Adapter Set

6
tlg./pcs.

Art.-Gruppe 120
Article Group 120

4259

Adapter Satz, 6-tlg. Adapter Set, 6 pieces

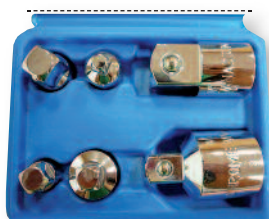

Art.-Nr./Art.-No.	Knarre/Ratchet	Nuss/Socket	€
4259	Adapter-Satz/Adapter Set		
Inhalt/Content	1/4" 25 mm	3/8"	
	3/8" 25 mm	1/4"	
	3/8" 33 mm	1/2"	
	1/2" 36 mm	3/8"	
	1/2" 49 mm	3/4"	
	3/4" 53 mm	1/2"	

Adapter

Adapter

Art.-Gruppe 120
Article Group 120



Art.-Nr./Art.-No.	Knarre/Ratchet	Nuss/Socket	€
4248	1/4" 25 mm	3/8"	
4245	3/8" 25 mm	1/4"	
4249	3/8" 33 mm	1/2"	
4250	1/2" 36 mm	3/8"	
4246	1/2" 49 mm	3/4"	
4251	3/4" 53 mm	1/2"	
4247	3/4" 62 mm	1"	
4252	1" 73 mm	3/4"	

1/2" Schlag Stecknüsse

1/2" Impact Sockets



Art.-Gruppe 120
Article Group 120

PROJAHN Schlag Stecknüsse sind aus einem speziellen Chrom-Vanadium-Molybdän-Stahl (CMbd) gefertigt. Diese Nüsse sind für den harten Einsatz mit Druckluftschraubern konzipiert.

PROJAHN impact Sockets are produced by a special Chrom-Vanadium-Molybdenum-Steel (CMbd). Due to this these Sockets are for hard use with impact drill machines.

1/2" Schlag Stecknüsse Impact Sockets



Art.-Nr./Art.-No.	Größe/Size	Länge/Length	€
380008	8 mm	39 mm	
380009	9 mm	39 mm	
380010	10 mm	39 mm	
380011	11 mm	39 mm	
380012	12 mm	39 mm	
380013	13 mm	39 mm	
380014	14 mm	39 mm	
380015	15 mm	39 mm	
380016	16 mm	39 mm	
380017	17 mm	39 mm	
380018	18 mm	39 mm	
380019	19 mm	39 mm	
380020	20 mm	39 mm	
380021	21 mm	39 mm	
380022	22 mm	39 mm	
380023	23 mm	39 mm	
380024	24 mm	39 mm	
380025	25 mm	39 mm	
380027	27 mm	39 mm	
380028	28 mm	39 mm	
380030	30 mm	48 mm	
380032	32 mm	48 mm	

1/2" Tiefe Schlag Stecknüsse Deep Impact Sockets

Deep Impact Sockets



Art.-Nr./Art.-No.	Größe/Size	Länge/Length	€
381008	8 mm	77 mm	
381009	9 mm	77 mm	
381010	10 mm	77 mm	
381011	11 mm	77 mm	
381012	12 mm	77 mm	
381013	13 mm	77 mm	
381014	14 mm	77 mm	
381015	15 mm	77 mm	
381016	16 mm	77 mm	
381017	17 mm	77 mm	
381018	18 mm	77 mm	
381019	19 mm	77 mm	
381020	20 mm	77 mm	
381021	21 mm	77 mm	
381022	22 mm	77 mm	
381023	23 mm	77 mm	
381024	24 mm	77 mm	
381025	25 mm	77 mm	
381027	27 mm	78 mm	
381028	28 mm	78 mm	
381030	30 mm	78 mm	
381032	32 mm	78 mm	

1/2" Tiefe Schlag Stecknüsse für Alu-Felgen

Thin-Wall Deep Impact Sockets



Kunststoffummantelt zum beschädigungsfreien Arbeiten an Alu-Felgen, die farbliche Unterscheidung ermöglicht ein schnelles Auffinden der verschieden großen Nüsse.

Thin-wall deep impact Sockets with plastic sleeve for a free of damage work on your aluminium rims. More easier to find the right Size because of different colors.

Art.-Nr./Art.-No.	Größe/Size	Länge/Length
382017	17 mm blau	85 mm
	blue	
382019	19 mm gold	85 mm
	gold	
382021	21 mm rot	85 mm
	red	
382022	22 mm hellgrün	85 mm
	light green	
382024	24 mm dunkelgrün	85 mm
	dark green	

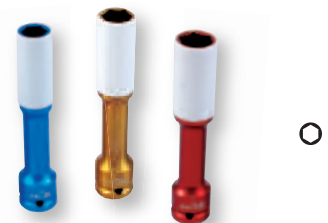

Art.-Nr./Art.-No.	Größe/Size	Länge/Length	€
382117	17 mm, blau	150 mm	
382117-1	Plastiküberzug blau		
382119	19 mm, gold	150 mm	
382119-1	Plastiküberzug gold		
382121	21 mm, rot	150 mm	
382121-1	Plastiküberzug rot		

Sortimente auf Seite / Sets on Page
H 129



Weitere PROForm-Werkstatteinlagen ab Seite /
More PROForm Inlays for Roller Cabinet from Page H 36

1/2" Schlag Stecknüsse und Zubehör

1/2" Impact Sockets And Accessories



Art.-Gruppe 120
Article Group 120

1/2" E-TX-Schlagnüsse

E-TX Impact Sockets



Art.-Nr./Art.-No.	Größe/Size	Länge/Length	€
384010	E10	38 mm	
384011	E11	38 mm	
384012	E12	38 mm	
384014	E14	38 mm	
384016	E16	38 mm	
384018	E18	38 mm	
384020	E20	38 mm	
384022	E22	45 mm	
384024	E24	45 mm	

1/2" Inbus Schlagnüsse

Hex Impact Sockets



Art.-Nr./Art.-No.	Größe/Size	Länge/Length	€
386004	4 mm	78 mm	
386005	5 mm	78 mm	
386006	6 mm	78 mm	
386008	8 mm	78 mm	
386010	10 mm	78 mm	
386012	12 mm	78 mm	
386014	14 mm	78 mm	
386017	17 mm	78 mm	
386019	19 mm	78 mm	

1/2" TX Schlagnüsse

TX Impact Sockets



Art.-Nr./Art.-No.	Größe/Size	€
385020	TX20	
385025	TX25	
385027	TX27	
385030	TX30	
385040	TX40	
385045	TX45	
385050	TX50	
385055	TX55	
385060	TX60	
385070	TX70	



Art.-Nr./Art.-No.	Größe/Size
381000	Kardangeln/Universal Joint



Art.-Nr./Art.-No.	Länge/Length
387075	Verlängerung 75 mm Extension Bar 75 mm
387125	Verlängerung 125 mm Extension Bar 125 mm



Art.-Nr./Art.-No.	Größe/Size
381214	1/2" Adapter für 1/4" Bits 1/2" Adapter For 1/4" Bits



Art.-Nr./Art.-No.	Größe/Size
381234	1/2" Adapter für 3/4" Nüsse 1/2" Adapter for 3/4" Sockets
381238	1/2" Adapter für 3/8" Nüsse 1/2" Adapter for 3/8" Sockets



Art.-Nr./Art.-No.	Größe/Size
381410	Sicherungs-O-Ring zu Nuss 10-14 mm Ring for 1/2" Sockets 10-14 mm
383216	Sicherungs-O-Ring zu Nuss 16-32 mm Ring for 1/2" Sockets 16-32 mm
391410	Sicherungsstift zu Nuss 10-14 mm Pin for 1/2" Sockets 10-14 mm
393216	Sicherungsstift zu Nuss 16-32 mm Pin for 1/2" Sockets 16-32 mm



Weitere PROForm-Werkstatteinlagen ab Seite /
More PROForm Inlays for Roller Cabinet from Page H 36

1/2" Schlag Stecknuss Sätze

1/2" Impact Socket Sets



Art.-Gruppe 120
Article Group 120

1/2" Schlagnuss Satz, 10-teilig

Impact Socket Set



10
tlg./pcs.



Art.-Nr./Art.-No.	Größe/Size
3080	10 - 13 - 14 - 16 - 17 - 18 - 19 - 21 - 22 - 24 mm

1/2" Schlagnuss Satz, 12-teilig

Impact Socket Set



12
tlg./pcs.



Art.-Nr./Art.-No.	Größe/Size
3086	10 - 11 - 13 - 14 - 17 - 19 - 21 - 22 - 23 - 24 mm Verlängerung 125 mm - Kardangelenk

1/2" Tiefer Schlagnuss Satz, 3-teilig

Deep Impact Socket Set



3
tlg./pcs.



Art.-Nr./Art.-No.	Größe/Size
3081	17 - 19 - 21 mm

1/2" Schlagnuss Satz, 3-teilig für Alufelgen

Thin-Wall Deep Impact Socket Set



3
tlg./pcs.



Art.-Nr./Art.-No.	Größe/Size
3082	17 - 19 - 21 mm

1/2" Schlagnuss Satz, 5-teilig für Alufelgen

Thin-Wall Deep Impact Socket Set



5
tlg./pcs.



Art.-Nr./Art.-No.	Größe/Size
3084	17 - 19 - 21 - 22 - 24 mm

1/2" Schlagnuss Satz, 6-teilig Extra tief für Alufelgen

Thin-Wall Extra Deep Impact Socket Set



6
tlg./pcs.



Art.-Nr./Art.-No.	Größe/Size
3083	17 - 19 - 21 mm

1/2" Inbus Schlagnuss Satz, 9-teilig

Hex Impact Socket Set



9
tlg./pcs.



Art.-Nr./Art.-No.	Größe/Size
3861	4 - 5 - 6 - 8 - 10 - 12 - 14 - 17 - 19 mm

1/2" TX Schlagnuss Satz, 9-teilig

TX Impact Socket Set



9
tlg./pcs.



Art.-Nr./Art.-No.	Größe/Size
3851	TX20 - TX25 - TX27 - TX30 - TX40 - TX45 - TX50 - TX55 - TX60

1/2" Xi-on MULTI Schlag Stecknüsse und Zubehör

1/2" Xi-on MULTI Impact Sockets And Accessories



Art.-Gruppe 120
Article Group 120



Wenn nichts mehr geht, greift Xi-on.

- ▶ Extrem innovativ: Revolutionäres Xi-on Spezialprofil öffnet bis zu 85% abgerundete Schrauben und Muttern
- ▶ Greift auch da noch, wo herkömmliche Stecknüsse versagen
- ▶ Öffnet alle gängigen metrischen 6-kant-, 12-kant- und Vielzahn-Muttern & -Schrauben
- ▶ Empfohlen von der Redaktion »Technik und Motor« der FAZ

If Nothing Works, Xi-on Helps.

- ▶ Extremely innovative: Revolutionary Xi-on special construction opens up to 85% rounded screws and screw nuts
- ▶ Easy working where even conventional sockets fail
- ▶ Opens all standard metric hex, double hex, spline screw nuts and screws
- ▶ Recommended by »Technik und Motor« of FAZ (established reputed Frankfurt Newspaper, Germany)



Xi-on

1/2" Schlag Stecknüsse

Impact Sockets ○

Inklusive passendem Sicherungs-O-Ring und Sicherungsstift

Safety ring and pin inclusive



Xi-on

1/2" Tiefe Schlag Stecknüsse

Deep Impact Sockets ○

Inklusive passendem Sicherungs-O-Ring und Sicherungsstift

Safety ring and pin inclusive



Xi-on

1/2" Tiefe Schlag Stecknüsse für Alu-Felgen

Thin-Wall Deep Impact Sockets ○



Art.-Nr./Art.-No.	Größe/Size	Länge/Length	€
418008	8 mm	39 mm	
418010	10 mm	39 mm	
418013	13 mm	39 mm	
418015	15 mm	39 mm	
418016	16 mm	39 mm	
418017	17 mm	39 mm	
418018	18 mm	39 mm	
418019	19 mm	39 mm	
418021	21 mm	39 mm	
418022	22 mm	39 mm	
418024	24 mm	39 mm	
418027	27 mm	39 mm	
418030	30 mm	48 mm	

Art.-Nr./Art.-No.	Größe/Size	Länge/Length	€
418108	8 mm	77 mm	
418110	10 mm	77 mm	
418113	13 mm	77 mm	
418115	15 mm	77 mm	
418117	17 mm	77 mm	
418118	18 mm	77 mm	
418119	19 mm	77 mm	
418121	21 mm	77 mm	
418122	22 mm	77 mm	
418124	24 mm	77 mm	
418130	30 mm	78 mm	

Art.-Nr./Art.-No.	Größe/Size	Länge/Length	€
418217	17 mm, blau	85 mm	
418219	19 mm, gelb	85 mm	
418221	21 mm, rot	85 mm	



Xi-on

1/2" Schlag Stecknuss Satz für Alufelgen, 3-teilig

Thin-Wall Deep Impact Socket Set, 3 pieces ○



Art.-Nr./Art.-No.	Größe/Size
4182	17 - 19 - 21 mm

- ▶ Kunststoffummantelung schützt Alufelgen vor Beschädigungen
- ▶ Schnelles Auffinden der passenden Stecknuss durch Farbleitsystem
- ▶ Alle Teile aus Chrom-Vanadium-Molybdän-Stahl (CMbd)
- ▶ Plastic coating reduces damages on aluminium rims
- ▶ Easy to find the right size because of the color coding system
- ▶ All parts produced by a special Chrom-Vanadium-Molybdenum-Steel (Cmbd)

3/4" Schlag Stecknüsse und Sätze

3/4" Impact Sockets And Sets



Art.-Gruppe 120
Article Group 120

3/4" Schlag Stecknüsse Impact Sockets



Art.-Nr./Art.-No.	Größe/Size	Länge/Length	€
480017	17 mm	51 mm	
480019	19 mm	51 mm	
480020	20 mm	51 mm	
480021	21 mm	51 mm	
480022	22 mm	51 mm	
480023	23 mm	51 mm	
480024	24 mm	51 mm	
480025	25 mm	51 mm	
480026	26 mm	51 mm	
480027	27 mm	51 mm	
480028	28 mm	54 mm	
480029	29 mm	54 mm	
480030	30 mm	54 mm	
480032	32 mm	56 mm	
480033	33 mm	57 mm	
480034	34 mm	57 mm	
480035	35 mm	57 mm	
480036	36 mm	57 mm	
480038	38 mm	57 mm	
480041	41 mm	57 mm	
480046	46 mm	65 mm	
480050	50 mm	72 mm	

3/4" Tiefe Schlag Stecknüsse Deep Impact Sockets



Art.-Nr./Art.-No.	Größe/Size	Länge/Length	€
481017	17 mm	89,5 mm	
481018	18 mm	89,5 mm	
481019	19 mm	89,5 mm	
481021	21 mm	89,5 mm	
481022	22 mm	89,5 mm	
481024	24 mm	89,5 mm	
481027	27 mm	89,5 mm	
481029	29 mm	89,5 mm	
481030	30 mm	89,5 mm	
481032	32 mm	89,5 mm	
481036	36 mm	89,5 mm	
481041	41 mm	89,5 mm	
481046	46 mm	89,5 mm	
481050	50 mm	89,5 mm	



Art.-Nr./Art.-No.	Größe/Size
483410	3/4" Adapter für 1" Nüsse 3/4" Adapter for 1" Sockets
483412	3/4" Adapter für 1/2" Nüsse 3/4" Adapter for 1/2" Sockets



Art.-Nr./Art.-No.	Größe/Size
482619	Sicherungs-O-Ring zu Nuss 19-26 mm Ring for 3/4" Sockets 19-26 mm
485027	Sicherungs-O-Ring zu Nuss 27-50 mm Ring for 3/4" Sockets 27-50 mm
492619	Sicherungsstift zu Nuss 19-26 mm Pin for 3/4" Sockets 19-26 mm
495027	Sicherungsstift zu Nuss 27-50 mm Pin for 3/4" Sockets 27-50 mm

3/4" Schlag Stecknüsse Satz, 8-teilig Impact Socket Set, 8 pieces



8
tlg./pcs.



Art.-Nr./Art.-No.	Größe/Size
3085	26 - 27 - 29 - 30 - 32 - 35 - 36 - 38 mm

3/4" Zubehör Accessories



Art.-Nr./Art.-No.	Größe/Size
481000	Kardangeln/Universal Joint



Art.-Nr./Art.-No.	Länge/Length
487100	Verlängerung 100 mm Extension Bar 100 mm
487200	Verlängerung 200 mm Extension Bar 200 mm

1" Schlag Stecknüsse, Satz und Zubehör

1" Impact Sockets And Set and Accessories



Art.-Gruppe 120
Article Group 120

1" Tiefe Schlag Stecknüsse

Deep Impact Sockets



1" Tiefe Schlag Stecknüsse Satz 8-teilig

Deep Impact Socket Set



8
tlg./pcs.

Art.-Nr./Art.-No.	Größe/Size	Länge/Length	€
580024	24 mm	90 mm	
580027	27 mm	90 mm	
580030	30 mm	90 mm	
580032	32 mm	90 mm	
580033	33 mm	90 mm	
580034	34 mm	90 mm	
580036	36 mm	90 mm	
580038	38 mm	90 mm	
580041	41 mm	90 mm	
580046	46 mm	100 mm	
580050	50 mm	100 mm	

Art.-Nr./Art.-No.	Größe/Size
3088	24 - 27 - 30 - 32 - 33 - 34 - 36 - 38 mm

1" Zubehör

Accessories



Art.-Nr./Art.-No.	Größe/Size
581000	Kardangelen/Universal Joint



Art.-Nr./Art.-No.	Größe/Size
581034	1" Adapter für 3/4" Nüsse 1" Adapter for 3/4" Sockets



Art.-Nr./Art.-No.	Größe/Size
587019	Sicherungs-O-Ring zu Nuss 19-70 mm Ring for 1" Sockets 19-70 mm



Art.-Nr./Art.-No.	Länge/Length
587200	Verlängerung 200 mm Extension Bar 200 mm

Schraubenschlüssel

Wrenches



High Tech mit GearTech

High Tech with GearTech

Ergonomisch

Ergonomic

- ▶ **Schlanke Ausführung der Ringseite ermöglicht den Einsatz an engsten Stellen wo herkömmliche Knarren und Steckschlüssel versagen**
 - ▶ **Professioneller Ratschenmechanismus mit 72 Zähnen und 5° Rückholwinkel verbessert zusätzlich das Arbeiten auf engstem Raum**
 - ▶ **Bis 10 mal schnellere Bearbeitung von Schrauben als mit herkömmlichen Schraubenschlüsseln**
 - ▶ **Schnelles Umschalten durch ergonomische Ein-Hand-Bedienung (Ausführung »Umschaltbar«)**
- ▶ *Slimline version of the ring end side allows working on narrow places where traditional ratchets and sockets fail*
- ▶ *Professional inside of the ratchet with 72 tooth and 5° returning angle improves working in a limited space additional*
- ▶ *Open or close screws up to 10 times faster then traditional wrenches*
- ▶ *Quick reversing due to an ergonomic one-hand function (Version »Reversible«)*

Vielseitig

Versatile

- ▶ **Für jeden Anwender der richtige Problemlöser durch breites Produktsortiment mit 8 verschiedenen Versionen**
 - ▶ **56-in-2 GearTech-Set – Ob metrisch, Inch, Vierkant oder Innen-TX – 56 Funktionen mit 2 GearTech-Schlüssel**
 - ▶ **Noch breitere Anwendungsvielfalt durch erweitertes Produktsortiment bis Größe 50 mm (Ausführung »Klassik«)**
 - ▶ **Große Produktauswahl an perfekt abgestimmten Sets in schützender Rolltasche**
- ▶ *For every user the right tool due to a wide product range with 8 different versions*
- ▶ *56-in-2 GearTech-Set – Whether metric, Inch, square or TX – 56 Functions with 2 GearTech wrenches*
- ▶ *Larger applying area due to an updated product range (Version »Classic«)*
- ▶ *Wide product range of perfect customized sets in a protective pouch*



Strapazierfähig und langlebig

Hardwearing and Durable

- ▶ **Langlebiger und dauerhaft belastbarer Ratschenmechanismus – speziell für den professionellen Einsatz aus vergütetem Spezialstahl präzisionsgefertigt**
 - ▶ **Hoch belastbar – Übersteigt die Drehmoment-Normen nach DIN 899 und ANSI**
 - ▶ **Mit widerstandsfähiger »Maul-Seite« zum Lösen extrem fest sitzender Schrauben**
- ▶ *Durable and long time resistant gear mechanism – produced of a special steel with a high level of precision specially for the professional work*
- ▶ *Hardwearing – exceeds the DIN 899 and ANSI standards*
- ▶ *With a high resistant open end side to loosen extremely tightened screws*

HINWEIS:

Extrem festsitzende Schrauben sind mit der Maul-Seite der GearTech Schlüssel zu lösen. Bei Überlastung droht Bruchgefahr!

Please note:

The GearTech wrenches are designed for fast screwing! In case of opening very hard fixed screws with the gear-side of the wrench, overstraining and breaking of the gear-mechanism is possible.

GearTech Ratschen-Ringgabelschlüssel

GearTech Ratchet Wrench



Art.-Gruppe 122
Article Group 122

GearTech Ratschenschlüssel klassik ohne Umschaltknopf, metrisch, verchromt

GearTech Ratchet Wrench „klassik“



Umschaltung links/rechts erfolgt einfach durch Umdrehen des Schlüssels.

Extrem festsetzende Schrauben sind mit der Maul-Seite der GearTech Schlüssel zu lösen.

Bei Überlastung droht Bruchgefahr!

Switch over is simply made by turning the wrench on the left/ on the right.

The GearTech Wrenches are designed for fast screwing!

In case of opening very hard fixed screws with the gear-side of the wrench, overtorquing and breaking of the gear-mechanism is possible.

Art.-Nr./Art.-No.	Größe/Size	Länge/Length	max Drehm./Max Torque	€
3406	6 mm	135 mm	27 Nm	
3407	7 mm	135 mm	33 Nm	
3408	8 mm	140 mm	43 Nm	
3409	9 mm	140 mm	57 Nm	
3410	10 mm	155 mm	86 Nm	
3411	11 mm	170 mm	98 Nm	
3412	12 mm	170 mm	112 Nm	
3413	13 mm	180 mm	143 Nm	
3414	14 mm	185 mm	191 Nm	
3415	15 mm	200 mm	250 Nm	
3416	16 mm	215 mm	264 Nm	
3417	17 mm	230 mm	319 Nm	
3418	18 mm	240 mm	359 Nm	
3419	19 mm	250 mm	385 Nm	
3421	21 mm	280 mm	435 Nm	
3422	22 mm	285 mm	506 Nm	
3424	24 mm	325 mm	630 Nm	
3427	27 mm	360 mm	699 Nm	
3430	30 mm	425 mm	837 Nm	
3432	32 mm	425 mm	987 Nm	
3434	34 mm	482 mm	987 Nm	
3436	36 mm	482 mm	987 Nm	
3438	38 mm	482 mm	1150 Nm	
34411	41 mm	550 mm	1300 Nm	
34461	46 mm	640 mm	1500 Nm	
34501	50 mm	640 mm	1700 Nm	

GearTech Ratschenschlüssel flexibel ohne Umschaltknopf, metrisch, verchromt

GearTech Ratchet Wrench „flexible“

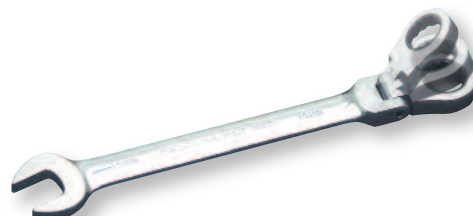

Umschaltung links/rechts erfolgt einfach durch Umdrehen des Schlüssels.

Extrem festsetzende Schrauben sind mit der Maul-Seite der GearTech Schlüssel zu lösen.

Bei Überlastung droht Bruchgefahr!

Switch over is simply made by turning the wrench on the left/ on the right.

The GearTech Wrenches are designed for fast screwing!

In case of opening very hard fixed screws with the gear-side of the wrench, overtorquing and breaking of the gear-mechanism is possible.

Art.-Nr./Art.-No.	Größe/Size	Länge/Length	max Drehm./Max Torque	€
3406F	6 mm	135 mm	27 Nm	
3407F	7 mm	135 mm	33 Nm	
3408F	8 mm	135 mm	43 Nm	
3409F	9 mm	143 mm	57 Nm	
3410F	10 mm	160 mm	86 Nm	
3411F	11 mm	170 mm	98 Nm	
3412F	12 mm	173 mm	112 Nm	
3413F	13 mm	180 mm	143 Nm	
3414F	14 mm	190 mm	191 Nm	
3415F	15 mm	200 mm	250 Nm	
3416F	16 mm	215 mm	264 Nm	
3417F	17 mm	230 mm	319 Nm	
3418F	18 mm	235 mm	359 Nm	
3419F	19 mm	250 mm	385 Nm	
3421F	21 mm	280 mm	435 Nm	
3422F	22 mm	285 mm	506 Nm	
3424F	24 mm	325 mm	630 Nm	
3427F	27 mm	365 mm	699 Nm	
3430F	30 mm	430 mm	837 Nm	
3432F	32 mm	440 mm	987 Nm	

GearTech Ratschen-Doppelringschlüssel

GearTech Ratchet Wrench



Art.-Gruppe 122
Article Group 122

GearTech Doppelringschlüssel klassik ohne Umschaltknopf, verchromt

Double Box GearTech Wrench



Umschaltung links/rechts erfolgt einfach durch Umdrehen des Schlüssels. Bei Überlastung droht Bruchgefahr!

Switch over is simply made by turning the wrench on the left/ on the right. The GearTech Wrenches are designed for fast screwing! In case of opening very hard fixed screws with the gear-side of the wrench, overtorquing and breaking of the gear-mechanism is possible.

Art.-Nr./Art.-No.	Größe/Size	Länge/Length	max Drehm./Max Torque	€
340810	8 x 10 mm	130 mm	43 Nm/ 86 Nm	
341013	10 x 13 mm	170 mm	86 Nm/143 Nm	
341213	12 x 13 mm	170 mm	112 Nm/143 Nm	
341415	14 x 15 mm	190 mm	191 Nm/250 Nm	
341618	16 x 18 mm	230 mm	264 Nm/359 Nm	
341719	17 x 19 mm	230 mm	319 Nm/385 Nm	

GearTech 4-in-1 umschaltbare Ratschen-Schlüssel

GearTech 4-in-1

Reversible Ratchet Wrenches



3463



Art.-Nr./Art.-No.	Größe/Size	€
3463	8x10 - 9x11 - 12x13 - 14x15 - 16x17 - 18x19 mm	Set 3-tlg.
3465	8x10 - 12x13 - 16x17 - 18x19 mm	Set 2-tlg.
390813	8x10 - 12x13 mm	einzeln/single
390915	9x11 - 14x15 mm	einzeln/single
391019	10x13 - 17x19 mm	einzeln/single
391619	16x17 - 18x19 mm	einzeln/single

GearTech Bit-Doppelringschlüssel

Umschaltbar, ergonomisch gebogen/
reversible, ergonomically curved



Art.-Nr./Art.-No.	Größe/Size	€
3914516	1/4" + 5/16"	

GearTech Ratschen-Ringgabelschlüssel

GearTech Ratchet Wrench

Art.-Gruppe 122
Article Group 122**3498 / 9981**4
tlg./pcs.**GearTech Ratschenschlüssel Satz, metrisch klassik ohne Umschaltknopf, in Rolltasche**

GearTech Set, „klassik“ in Pouch

5
tlg./pcs.**3498 Inhalt/Contents:** je 1 GearTech Ratschenschl. 10 - 13 - 17 - 19 mm**9981 Inhalt/Contents:** je 1 GearTech Ratschenschl. 8 - 10 - 13 - 17 - 19 mm

Art.-Nr./Art.-No.	€
3498	4-tlg./pcs.
9981	5-tlg./pcs.
3499E	Rolltasche leer/empty

**3499****GearTech Ratschenschlüssel Satz, metrisch klassik ohne Umschaltknopf, in Rolltasche**

GearTech Set, „klassik“ in Pouch

8
tlg./pcs.**Inhalt/Contents:**

je 1 GearTech Ratschenschlüssel 8 - 10 - 12 - 13 - 16 - 17 - 18 - 19 mm

Art.-Nr./Art.-No.	€
3499	8-tlg./pcs.
3499E	Rolltasche leer/empty

**3494****GearTech Ratschenschlüssel Satz, metrisch klassik ohne Umschaltknopf, in Rolltasche**

GearTech Set, „klassik“ in Pouch

14
tlg./pcs.**Inhalt/Contents:** je 1 GearTech Ratschenschlüssel

6 - 7 - 8 - 9 - 10 - 11 - 12 - 13 - 14 - 15 - 16 - 17 - 18 - 19 mm

Art.-Nr./Art.-No.	€
3494	14-tlg./pcs.
3494E	Rolltasche leer/empty

**3500****GearTech Ratschenschlüssel Satz, metrisch, klassik ohne Umschaltknopf, in Rolltasche**

GearTech Set, „klassik“ in Pouch

20
tlg./pcs.**Inhalt/Contents:** je 1 GearTech Ratschenschlüssel 6 - 7 - 8 - 9 - 10 - 11 -

12 - 13 - 14 - 15 - 16 - 17 - 18 - 19 - 21 - 22 - 24 - 27 - 30 - 32 mm

Art.-Nr./Art.-No.	€
3500	20-tlg./pcs.
3500E	Rolltasche leer/empty



GearTech Ratschen-Ringgabelschlüssel

GearTech Ratchet Wrench

Art.-Gruppe 122
Article Group 122**3496****GearTech Ratschenschlüssel Satz,
metrisch, flexibel, in Rolltasche**

GearTech Set, „flexible“ in Pouch

4
tlg./pcs.

Inhalt/Contents: je 1 GearTech Ratschenschlüssel 10 - 13 - 17 - 19 mm

Art.-Nr./Art.-No.	€
3496	4-tlg./pcs.
3499E	Rolltasche leer/empty

**3497****GearTech Ratschenschlüssel Satz,
metrisch, flexibel, in Rolltasche**

GearTech Set, „flexible“ in Pouch

8
tlg./pcs.

Inhalt/Contents:

je 1 GearTech Ratschenschlüssel 8 - 10 - 12 - 13 - 16 - 17 - 18 - 19 mm

Art.-Nr./Art.-No.	€
3497	8-tlg./pcs.
3499E	Rolltasche leer/empty

**3493****GearTech Ratschenschlüssel Satz,
metrisch, flexibel, in Rolltasche**

GearTech Set, „flexible“ in Pouch

14
tlg./pcs.

Inhalt/Contents: je 1 GearTech Ratschenschlüssel

6 - 7 - 8 - 9 - 10 - 11 - 12 - 13 - 14 - 15 - 16 - 17 - 18 - 19 mm

Art.-Nr./Art.-No.	€
3493	14-tlg./pcs.
3494E	Rolltasche leer/empty

**3502****GearTech Ratschenschlüssel Satz,
metrisch, flexibel, in Rolltasche**

GearTech Set, „flexible“ in Pouch

20
tlg./pcs.

Inhalt/Contents: je 1 GearTech Ratschenschlüssel 6 - 7 - 8 - 9 - 10 -

11 - 12 - 13 - 14 - 15 - 16 - 17 - 18 - 19 - 21 - 22 - 24 - 27 - 30 - 32 mm

Art.-Nr./Art.-No.	€
3502	20-tlg./pcs.
3500E	Rolltasche leer/empty

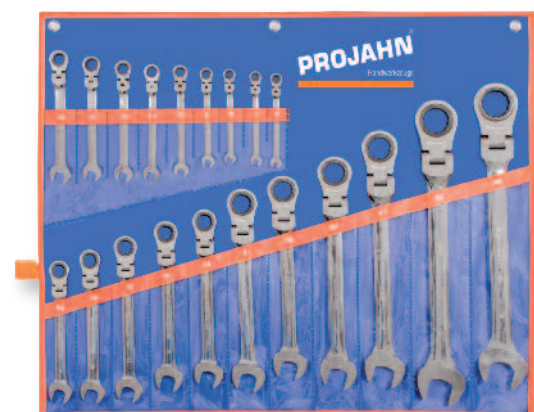

GearTech Ratschen-Ringgabelschlüssel

GearTech Ratchet Wrench

Art.-Gruppe 122
Article Group 122**3993****GearTech Ratschenschlüssel Satz,
metrisch, umschaltbar, in Rolltasche**

GearTech Set „reversible“ in Pouch

4
tlg./pcs.

Inhalt/Contents: je 1 GearTech Ratschenschlüssel 10 - 13 - 17 - 19 mm

Art.-Nr./Art.-No.	€
3993	4-tlg./pcs.
3499E	Rolltasche leer/empty

**3999****GearTech Ratschenschlüssel Satz,
metrisch, umschaltbar, in Rolltasche**

GearTech Set „reversible“ in Pouch

8
tlg./pcs.

Inhalt/Contents:

je 1 GearTech Ratschenschlüssel 8 - 10 - 12 - 13 - 16 - 17 - 18 - 19 mm

Art.-Nr./Art.-No.	€
3999	8-tlg./pcs.
3499E	Rolltasche leer/empty

**3994****GearTech Ratschenschlüssel Satz,
metrisch, umschaltbar, in Rolltasche**

GearTech Set „reversible“ in Pouch

14
tlg./pcs.

Inhalt/Contents: je 1 GearTech Ratschenschlüssel

6 - 7 - 8 - 9 - 10 - 11 - 12 - 13 - 14 - 15 - 16 - 17 - 18 - 19 mm

Art.-Nr./Art.-No.	€
3994	14-tlg./pcs.
3494E	Rolltasche leer/empty

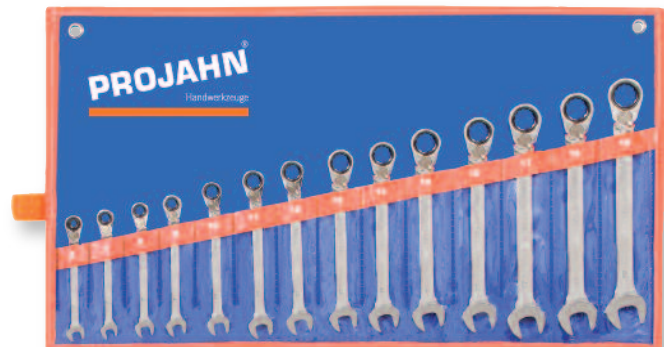
**3501****GearTech Ratschenschlüssel Satz,
metrisch, umschaltbar, in Rolltasche**

GearTech Set „reversible“ in Pouch

20
tlg./pcs.

Inhalt/Contents: je 1 GearTech Ratschenschlüssel 6 - 7 - 8 - 9 - 10 - 11 -

12 - 13 - 14 - 15 - 16 - 17 - 18 - 19 - 21 - 22 - 24 - 27 - 30 - 32 mm

Art.-Nr./Art.-No.	€
3501	20-tlg./pcs.
3500E	Rolltasche leer/empty

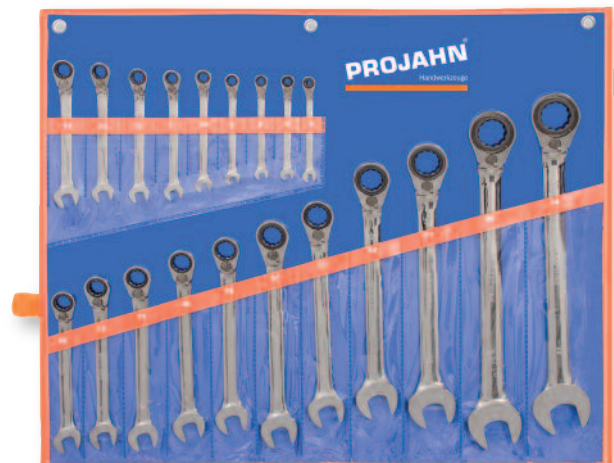

GearTech Ratschenschlüssel

GearTech Ratchet Wrenches



Art-Gruppe 122
Article Group 122

3466

2
tlg./pcs.

GearTech 63-in-2 (Set 2-teilig)
umschaltbare Ratschen-Schlüssel in Rolltaschen

GearTech 63-in-2 Reversible Ratchet Wrench in Pouch



Anwendungsübersicht / Application Overview

Größe/Size		Größe/Size		Größe/Size		Größe/Size		Größe/Size	
6-kant/ Hex		12-kant/ Double hex		4-kant/ Square		Vielzahn/ Spline		TORX®E	
mm	inch	mm	inch	mm	inch	mm			
8	5/16	8	5/16	7	9/32	8			E10
10	3/8	10	3/8		11/32	10			E12
11	7/16	11	7/16	9	3/8	11			E14
13	1/2	13	1/2	11	7/16	13			E16
14	9/16	14	9/16	12	15/32	14			E18
16	5/8	16	5/8	13	17/32	16			E20
17	11/16	17	11/16	14	9/16	17			E22
19	3/4	19	3/4	16	5/8	19			E24

- ▶ Umschaltbarer GearTech Ratschenschlüssel mit Multifunktions-Ratscheneinsatz
- ▶ Jeder Schlüssel funktioniert an mehr als 30 verschiedenen Schraubenantrieben
- ▶ 4-kant, 6-kant, 12-kant, Vielzahn und TORX®E mit einem Schlüssel bearbeiten
- ▶ Passend für metrische und zöllige Schraubenantriebe
- ▶ Reversible GearTech ratchet wrench with multifunctional ratchet insert
- ▶ Every wrench works on more than 30 different fasteners
- ▶ Square, hex, double hex, Spline, TORX®E handling with one wrench
- ▶ Fits for metric and inch fasteners

Art.-Nr./Art.No.	Größe/Size	€
3466	8 - 10 - 11 - 13 - 14 - 16 - 17 - 19 mm, 5/16" - 3/8" - 7/16" - 1/2" - 9/16" - 5/8" - 11/16" - 3/4"	
	E10 - E12 - E14 - E16 - E18 - E20 - E22 - E24	

3466-01

GearTech 31-in-1
umschaltbarer Ratschen-Schlüssel
GearTech 31-in-1 Reversible Ratchet Wrench



Anwendungsübersicht / Application Overview

Größe/Size		Größe/Size		Größe/Size		Größe/Size		Größe/Size	
6-kant/ Hex		12-kant/ Double hex		4-kant/ Square		Vielzahn/ Spline		TORX®E	
mm	inch	mm	inch	mm	inch	mm			
8	5/16	8	5/16	7	9/32	8			E10
10	3/8	10	3/8		11/32	10			E12
11	7/16	11	7/16	9	3/8	11			E14
13	1/2	13	1/2	11	7/16	13			E16

Art.-Nr./Art.No.	Größe/Size	€
3466-01	8 - 10 - 11 - 13 mm 5/16" - 7/16" - 3/8" - 1/2"	
	E10 - E12 - E14 - E16	

3466-02

GearTech 32-in-1
umschaltbarer Ratschen-Schlüssel
GearTech 32-in-1 Reversible Ratchet Wrench



Anwendungsübersicht / Application Overview

Größe/Size		Größe/Size		Größe/Size		Größe/Size		Größe/Size	
6-kant/ Hex		12-kant/ Double hex		4-kant/ Square		Vielzahn/ Spline		TORX®E	
mm	inch	mm	inch	mm	inch	mm			
14	9/16	14	9/16	12	15/32	14			E18
16	5/8	16	5/8	13	17/32	16			E20
17	11/16	17	11/16	14	9/16	17			E22
19	3/4	19	3/4	16	5/8	19			E24

Art.-Nr./Art.No.	Größe/Size	€
3466-02	14 - 16 - 17 - 19 mm 9/16" - 11/16" - 5/8" - 3/4"	
	E18 - E20 - E22 - E24	

GearTech Ratschenschlüssel

GearTech Ratchet Wrenches

Art.-Gruppe 122
Article Group 122**3465****GearTech 4-in-1 (Set 2-teilig)
umschaltbare Ratschen-Schlüssel
in Rolltasche**GearTech 4-in-1 (2 pieces)
Reversible Ratchet Wrenches
in Pouch2
tlg./pcs.

Nur 1 umschaltbarer GearTech Schlüssel um 4 Größen zu schrauben!
Jede Seite des doppelseitigen Schlüssels beinhaltet 2 Größen =
4 Größen pro Schlüssel. Jede Größe ist umschaltbar von links nach rechts.

Art.-Nr./Art.-No.	Größe/Size	€
3465	8x10 - 12x13 - 16x17 - 18x19 mm	Set 2-tlg.

3463**GearTech 4-in-1 (Set 3-teilig)
umschaltbare Ratschen-Schlüssel
in Rolltasche**GearTech 4-in-1 (3 pieces)
Reversible Ratchet Wrenches
in Pouch3
tlg./pcs.

Nur 1 umschaltbarer GearTech Schlüssel um 4 Größen zu schrauben!
Jede Seite des doppelseitigen Schlüssels beinhaltet 2 Größen =
4 Größen pro Schlüssel. Jede Größe ist umschaltbar von links nach rechts.

Art.-Nr./Art.-No.	Größe/Size	€
3463	8x10 - 9x11 - 12x13 - 14x15 - 16x17 - 18x19 mm	Set 3-tlg.

Spezial Stecknuss Adapter für GearTech Schlüssel
Socket and Bit Adapter for GearTech Wrenches4
tlg./pcs.

Art.-Nr./Art.-No.	Größe/Size	€
3690	Satz 4-tlg./Set 4 pieces	1/4" - 3/8" - 1/2" - 1/4" Bit

Schraubenschlüssel

Wrenches

Art.-Gruppe 123
Article Group 123

**Ringgabelschlüssel
metrisch,
nach DIN 3113 Form A,
mattsatiniert**

Combination Wrenches, Metric

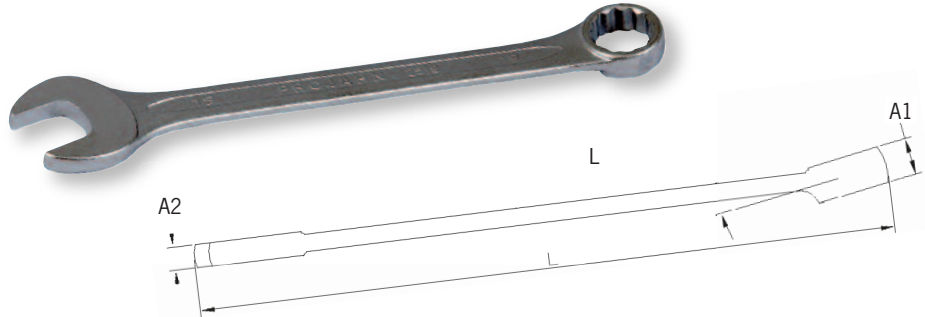

- ▶ **Größere Auflagefläche, höhere Lebensdauer**
- ▶ **Anziehen mit der Schraubenfläche und nicht über die Schraubenkante**
- ▶ **Maulstellung 15°, Ringseite 15° abgewinkelt**
- ▶ **Vernickelt und verchromt matt satiniertes Oberflächenfinish**
- ▶ **Köpfe hochglanzpoliert**

- ▶ *Larger contact surface, higher service life*
- ▶ *Tightening by the screw surface, not by the edges of the screw*
- ▶ *Jaw position 15°, ring end 15° angled*
- ▶ *Nickel- and chromium-plated in satin mat finish*
- ▶ *Heads mirrorpolished*

Art.-Nr./Art.-No.	L x A2 x A1	Größe/Size	€
2505	93 x 3,4 x 4,0 mm	5,5 mm	
2506	100 x 3,7 x 4,5 mm	6 mm	
2507	110 x 3,7 x 5,0 mm	7 mm	
2508	120 x 4,1 x 5,5 mm	8 mm	
2509	130 x 4,1 x 6,0 mm	9 mm	
2510	140 x 4,6 x 6,5 mm	10 mm	
2511	150 x 4,7 x 6,5 mm	11 mm	
2512	160 x 4,8 x 7,0 mm	12 mm	
2513	170 x 5,5 x 7,5 mm	13 mm	
2514	180 x 5,6 x 8,0 mm	14 mm	
2515	190 x 5,7 x 8,5 mm	15 mm	
2516	200 x 5,8 x 9,0 mm	16 mm	
2517	210 x 6,3 x 9,5 mm	17 mm	
2518	220 x 6,8 x 10,0 mm	18 mm	
2519	230 x 7,1 x 10,4 mm	19 mm	
2520	240 x 7,2 x 10,9 mm	20 mm	
2521	250 x 7,5 x 11,4 mm	21 mm	
2522	260 x 8,0 x 11,9 mm	22 mm	

Art.-Nr./Art.-No.	L x A2 x A1	Größe/Size	€
2523	260 x 8,0 x 11,9 mm	23 mm	
2524	280 x 8,2 x 12,9 mm	24 mm	
2525	295 x 8,7 x 13,4 mm	25 mm	
2526	295 x 8,7 x 13,4 mm	26 mm	
2527	310 x 8,9 x 14,4 mm	27 mm	
2528	340 x 10,0 x 15,9 mm	28 mm	
2529	340 x 10,0 x 15,9 mm	29 mm	
2530	340 x 10,0 x 15,9 mm	30 mm	
2532	360 x 10,8 x 16,9 mm	32 mm	
25361	480 x 14,5 x 17,0 mm	36 mm	
25411	540 x 16,0 x 20,0 mm	41 mm	
25461	605 x 16,0 x 20,0 mm	46 mm	
25501	615 x 17,0 x 21,0 mm	50 mm	
25551	560 x 21,0 x 28,0 mm	55 mm	
25601	600 x 23,0 x 30,0 mm	60 mm	
25651	675 x 23,7 x 32,7 mm	65 mm	
25701	675 x 23,7 x 32,7 mm	70 mm	

Schraubenschlüssel

Wrenches

Art.-Gruppe 123
Article Group 123

**Ringgabelschlüssel
metrisch,
nach DIN 3113 Form B,
mattsatiniert**

Combination Wrenches, Metric

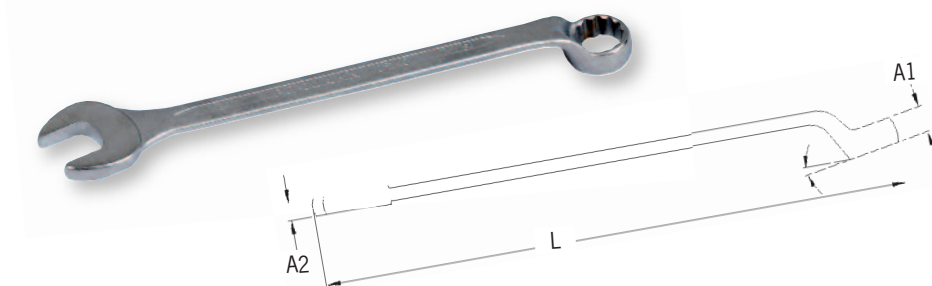

Art.-Nr./Art.-No.	L x A2 x A1	Größe/Size	€
25062	125 x 3,7 x 5,2 mm	6 mm	
25072	135 x 3,7 x 5,7 mm	7 mm	
25082	145 x 4,1 x 6,3 mm	8 mm	
25092	155 x 4,1 x 7,3 mm	9 mm	
25102	165 x 4,6 x 7,3 mm	10 mm	
25112	172 x 4,9 x 8,1 mm	11 mm	
25122	180 x 4,9 x 8,8 mm	12 mm	
25132	195 x 5,9 x 9,6 mm	13 mm	
25142	210 x 5,9 x 9,8 mm	14 mm	
25152	215 x 6,4 x 10,0 mm	15 mm	
25162	230 x 6,8 x 10,9 mm	16 mm	
25172	240 x 7,1 x 11,6 mm	17 mm	
25182	255 x 7,4 x 12,2 mm	18 mm	

Art.-Nr./Art.-No.	L x A2 x A1	Größe/Size	€
25192	265 x 8,4 x 12,8 mm	19 mm	
25212	280 x 7,5 x 11,5 mm	21 mm	
25222	300 x 8,6 x 13,1 mm	22 mm	
25232	320 x 9,0 x 14,0 mm	23 mm	
25242	320 x 9,0 x 14,0 mm	24 mm	
25252	348 x 9,0 x 14,0 mm	25 mm	
25262	348 x 10,4 x 15,3 mm	26 mm	
25272	348 x 10,4 x 15,3 mm	27 mm	
25282	370 x 10,8 x 16,0 mm	28 mm	
25292	390 x 11,4 x 16,5 mm	29 mm	
25302	390 x 11,4 x 16,5 mm	30 mm	
25322	412 x 12,0 x 17,5 mm	32 mm	

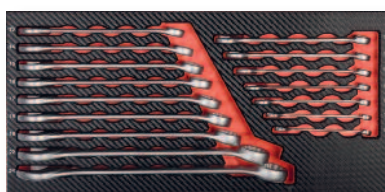

Weitere PROForm-Werkstatteinlagen ab Seite /
More PROForm Inlays for Roller Cabinet from Page **H 36**

Lange Ringgabelschlüssel

Combination Wrenches XL

Art.-Gruppe 123
Article Group 123

Lange Ringgabelschlüssel metrisch, nach DIN 3113 Form A

Combination Wrenches, Metric, XL



- ▶ Größere Auflagefläche, höhere Lebensdauer
 - ▶ Anziehen mit der Schraubenfläche und nicht über die Schraubenkante
 - ▶ Maulstellung 15°, Ringseite 15° abgewinkelt
 - ▶ Vernickelt und verchromt matt satiniertes Oberflächenfinish
 - ▶ Lange Ausführung
-
- ▶ Larger contact surface, higher service life
 - ▶ Tightening by the screw surface, not by the edges of the screw
 - ▶ Jaw position 15°, ring end 15° angled
 - ▶ Nickel- and chromium-plated in satin mat finish
 - ▶ Long pattern

Art.-Nr./Art.-No.	L x A2 x A1	Größe/Size	€
25081	148 x 4,1 x 5,5 mm	8 mm	
25091	167 x 4,1 x 6,0 mm	9 mm	
25101	172 x 4,6 x 6,5 mm	10 mm	
25111	186 x 4,7 x 6,5 mm	11 mm	
25121	197 x 4,8 x 7,0 mm	12 mm	
25131	207 x 5,5 x 7,5 mm	13 mm	
25141	223 x 5,6 x 8,0 mm	14 mm	
25151	233 x 5,7 x 8,5 mm	15 mm	
25161	243 x 5,8 x 9,0 mm	16 mm	
25171	261 x 6,3 x 9,5 mm	17 mm	
25181	270 x 6,8 x 10,0 mm	18 mm	
25191	280 x 7,1 x 10,4 mm	19 mm	
25201	290 x 7,2 x 10,9 mm	20 mm	
25211	301 x 7,5 x 11,4 mm	21 mm	
25221	318 x 8,0 x 11,9 mm	22 mm	
25241	338 x 8,2 x 12,9 mm	24 mm	
25271	376 x 8,9 x 14,4 mm	27 mm	
25301	394 x 10,0 x 15,9 mm	30 mm	
25321	435 x 10,8 x 16,9 mm	32 mm	

Ringgabelschlüssel, Zoll

Combination Wrenches, Inch

Art.-Gruppe 123
Article Group 123

Ringgabelschlüssel, Zoll, hochglanzpoliert

Combination Wrenches, Inch

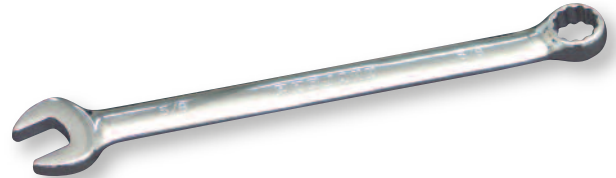

- ▶ Größere Auflagefläche, höhere Lebensdauer
 - ▶ Anziehen mit der Schraubenfläche und nicht über die Schraubenkante
 - ▶ Maulstellung 15°, Ringseite 15° abgewinkelt
 - ▶ Hochglanzpoliert
-
- ▶ Larger contact surface, higher service life
 - ▶ Tightening by the screw surface, not by the edges of the screw
 - ▶ Jaw position 15°, ring end 15° angled
 - ▶ Mirror polished

Art.-Nr./Art.-No.	Größe/Size	Länge/Length	€
2561	1/4"	130 mm	
2562	5/16"	145 mm	
2563	3/8"	165 mm	
2564	7/16"	185 mm	
2565	1/2"	205 mm	
2566	9/16"	220 mm	
2567	5/8"	240 mm	
2568	11/16"	260 mm	
2569	3/4"	280 mm	
2570	7/8"	315 mm	
2571	15/16"	335 mm	
2572	1"	355 mm	

DOLPHIN Ringgabelschlüssel

DOLPHIN Combination Wrenches

Art.-Gruppe 123
Article Group 123

DOLPHIN Ringgabelschlüssel, metrisch

*DOLPHIN Combination Wrenches,
Metric*

NEU/NEW



- ▶ **Breiterer Anwendungsbereich**
- ▶ **25% höhere Kraftübertragung**
- ▶ **Hochwertige Verarbeitung und Materialien**
 - **Robuste, langlebige Qualität**
 - **Übertrifft DIN-/ANSI-Normen**
- ▶ **Innovative Ringgeometrie ermöglicht das Verschrauben in Vertiefungen**
- ▶ **Spezielle Winkelgeometrie maximiert die Kontaktfläche**

- ▶ *Wider scope as standard combination wrenches*
- ▶ *25% higher power transmission*
- ▶ *High-quality manufacture and materials*
 - *Sturdy, durable quality*
 - *Exceeds DIN-/ANSI-Standard*
- ▶ *Innovative ring geometry allows screwing in grooves*
- ▶ *Special angle geometry maximizes the contact area*

Art.-Nr./Art.-No.	Größe/Size	Länge/Length	€
25065	6 mm	140 mm	
25075	7 mm	145 mm	
25085	8 mm	153 mm	
25095	9 mm	162 mm	
25105	10 mm	150 mm	
25115	11 mm	175 mm	
25125	12 mm	185 mm	
25135	13 mm	175 mm	
25145	14 mm	185 mm	
25155	15 mm	215 mm	
25165	16 mm	200 mm	
25175	17 mm	235 mm	
25195	19 mm	235 mm	
25225	22 mm	290 mm	
25245	24 mm	300 mm	
25275	27 mm	350 mm	
25305	30 mm	405 mm	
25325	32 mm	410 mm	

CLICKTECH Ratschen-Ringgabelschlüssel

CLICKTECH Ratchet Combination Wrenches

Art.-Gruppe 123
Article Group 123

CLICKTECH Ratschen-Ringgabelschlüssel, metrisch

*CLICKTECH Ratchet Combination Wrenches,
Metric*

NEU/NEW

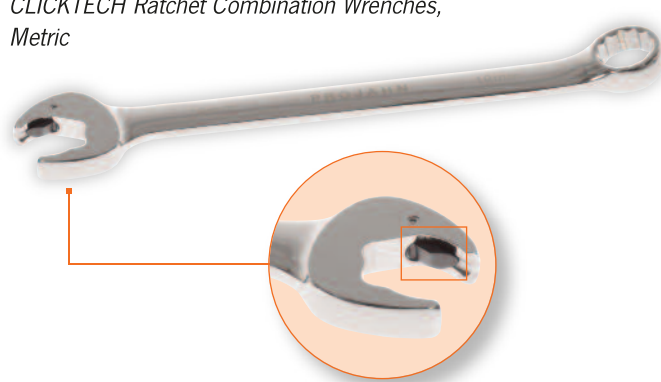

- ▶ **Ringgabelschlüssel mit Ratschenfunktion auf der Gabelseite**
 - **Ermöglicht Arbeiten bei extrem engem Arbeitsbereich**
 - **Verschraubung ohne wiederholtes Neu-Ansetzen des Schraubenschlüssels**
- ▶ **Hochwertige Verarbeitung und Materialien**
 - **Robuste, langlebige Qualität**
- ▶ **Lösen extrem festsitzender Verbindungen durch Ringseite möglich**

- ▶ *Combination wrench with ratchet function at the open end*
 - *Allows working on extremely narrow places*
 - *Screwing without repeated placing of the wrench*
- ▶ *High quality workmanship and materials*
 - *Sturdy, durable quality*
- ▶ *Loosen extremely tightened screws with ring end*

Art.-Nr./Art.-No.	Größe/Size	Länge/Length	€
250008	8 mm	136 mm	
250010	10 mm	161 mm	
250012	12 mm	174 mm	
250013	13 mm	180 mm	
250016	16 mm	207 mm	
250017	17 mm	227 mm	
250018	18 mm	239 mm	
250019	19 mm	250 mm	

Sortimente auf Seite /Sets on Page

H 155

Doppelgabelschlüssel

Double Open End Wrenches

Art.-Gruppe 123
Article Group 123

Doppelgabelschlüssel metrisch, nach DIN 3110

Double Open End Wrenches, Metric

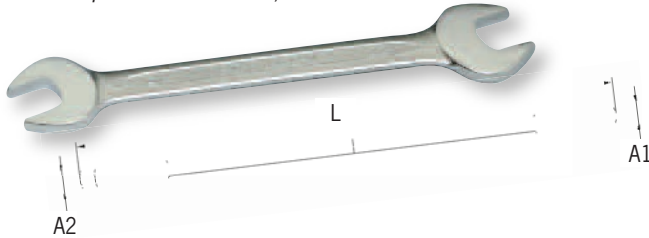

- ▶ Gabelstellung 15°
- ▶ Vernickelt + verchromt matt satiniertes Oberflächenfinish

- ▶ Open end position 15°
- ▶ Nickel- and chromium-plated in satin mat finish

Art.-Nr./Art.-No.	L x A2/A1	Größe/Size	€
250607	122 x 3,3 mm	6 x 7 mm	
250809	140 x 3,6 mm	8 x 9 mm	
251008	140 x 3,6 mm	8 x 10 mm	
251011	156 x 4,6 mm	10 x 11 mm	
251013	172 x 5,1 mm	10 x 13 mm	
251213	172 x 5,1 mm	12 x 13 mm	
251317	188 x 5,6 mm	13 x 17 mm	
251415	188 x 5,6 mm	14 x 15 mm	
251617	204 x 6,1 mm	16 x 17 mm	
251719	220 x 6,5 mm	17 x 19 mm	
251819	220 x 6,5 mm	18 x 19 mm	
251922	234 x 7,2 mm	19 x 22 mm	
252022	234 x 7,2 mm	20 x 22 mm	
252123	247 x 7,5 mm	21 x 23 mm	
252224	247 x 7,5 mm	22 x 24 mm	
252426	266 x 8,2 mm	24 x 26 mm	
252427	266 x 8,2 mm	24 x 27 mm	
252430	285 x 8,2 mm	24 x 30 mm	
252528	285 x 8,4 mm	25 x 28 mm	
252730	302 x 9,1 mm	27 x 30 mm	
252732	302 x 9,1 mm	27 x 32 mm	
253032	302 x 9,1 mm	30 x 32 mm	
253641	380 x 12,2 mm	36 x 41 mm	
254146	415 x 14,7 mm	41 x 46 mm	
254650	465 x 15,7 mm	46 x 50 mm	

Doppelringschlüssel

Double Ring Wrenches

Art.-Gruppe 123
Article Group 123

Doppelringschlüssel metrisch, nach DIN 838

Double Ring Wrenches, Metric

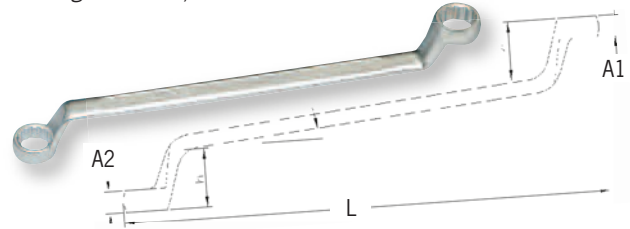

- ▶ Tief gekröpft 75°
- ▶ Vernickelt + verchromt matt satiniertes Oberflächenfinish

- ▶ 75° offset
- ▶ Nickel- and chromium-plated in satin mat finish

Art.-Nr./Art.-No.	L x A2 x A1	Größe/Size	€
240607	170 x 5,6 x 4,9 mm	6 x 7 mm	
240809	182 x 6,8 x 6,0 mm	8 x 9 mm	
241011	197 x 7,9 x 7,4 mm	10 x 11 mm	
241013	213 x 8,9 x 8,4 mm	10 x 13 mm	
241213	213 x 8,9 x 8,4 mm	12 x 13 mm	
241317	250 x 8,9 x 11,4 mm	13 x 17 mm	
241415	228 x 9,9 x 9,4 mm	14 x 15 mm	
241617	246 x 10,9 x 10,4 mm	16 x 17 mm	
241618	246 x 10,9 x 10,4 mm	16 x 18 mm	
241719	265 x 11,9 x 11,4 mm	17 x 19 mm	
241819	265 x 11,9 x 11,4 mm	18 x 19 mm	
242022	288 x 12,9 x 12,4 mm	20 x 22 mm	
242123	310 x 13,3 x 12,3 mm	21 x 23 mm	
242426	330 x 14,3 x 13,7 mm	24 x 26 mm	
242427	330 x 14,3 x 13,7 mm	24 x 27 mm	
242528	348 x 14,7 x 14,2 mm	25 x 28 mm	
243032	372 x 15,8 x 14,8 mm	30 x 32 mm	
243641	570 x 18,0 x 19,5 mm	36 x 41 mm	

Schraubenschlüssel

Wrenches

Art.-Gruppe 123
Article Group 123

PROFESSIONAL PLUS STANDARD

Rohrsteckschlüssel

leichte Ausführung

Double Ended Socket Wrenches

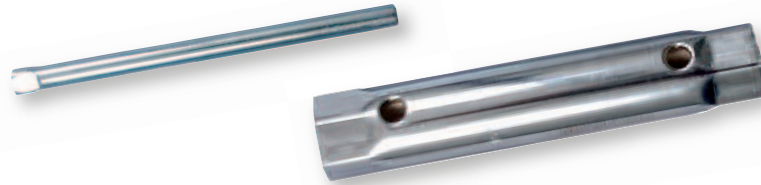

Art.-Nr./Art.-No.	Größe/Size	€
260607	6 x 7 mm	
260809	8 x 9 mm	
261011	10 x 11 mm	
261213	12 x 13 mm	
261415	14 x 15 mm	
261617	16 x 17 mm	
261719	17 x 19 mm	

Art.-Nr./Art.-No.	Größe/Size	€
261819	18 x 19 mm	
262022	20 x 22 mm	
262123	21 x 23 mm	
262427	24 x 27 mm	
260001	Drehstift/Tommy Bar 146 mm (6 - 13 mm)	
260002	Drehstift/Tommy Bar 146 mm (14 - 27 mm)	

Sortiment auf Seite /Set on Page
H 156

PROFESSIONAL PLUS STANDARD

Einmaulschlüssel nach DIN 894

Single Open End Wrench



- Aus extrem stabilem Stahl gefertigt
- Produced by special steel

Art.-Nr./Art.-No.	Länge/Length	Größe/Size	€
25244	195 mm	24 mm	
25274	215 mm	27 mm	
25304	240 mm	30 mm	
25324	270 mm	32 mm	
25364	295 mm	36 mm	
25384	295 mm	38 mm	
25414	335 mm	41 mm	

Art.-Nr./Art.-No.	Länge/Length	Größe/Size	€
25424	335 mm	42 mm	
25464	368 mm	46 mm	
25484	410 mm	48 mm	
25504	410 mm	50 mm	
25554	490 mm	55 mm	
25604	490 mm	60 mm	
25654	490 mm	65 mm	

Schraubenschlüssel

Wrenches

Art.-Gruppe 123
Article Group 123

PROFESSIONAL PLUS STANDARD

Offene Doppelringschlüssel Köpfe 15° abgewinkelt, nach DIN 3118, mattsatiniert verchromt

Flare Nut Wrenches

Head with 15°, Satin Mat Finish

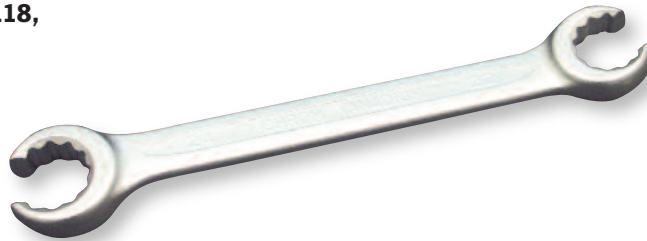

Art.-Nr./Art.-No.	Größe/Size	Aufnahme/Drive	€
220810	8 x 10 mm	6 x 6-kant	
220911	9 x 11 mm	6 x 6-kant	
221011	10 x 11 mm	6 x 6-kant	
221012	10 x 12 mm	6 x 6-kant	
221214	12 x 14 mm	6 x 6-kant	
221315	13 x 15 mm	12 x 12-kant	
221417	14 x 17 mm	12 x 12-kant	
221618	16 x 18 mm	12 x 12-kant	
221719	17 x 19 mm	12 x 12-kant	
221922	19 x 22 mm	12 x 12-kant	
222224	22 x 24 mm	12 x 12-kant	

Art.-Nr./Art.-No.	Größe/Size	Aufnahme/Drive	€
2203	3/8" x 7/16"	6 x 6-kant	
2205	1/2" x 9/16"	6 x 6-kant	
2207	11/16" x 3/4"	12 x 12-kant	
2210	7/8" x 15/16"	12 x 12-kant	

Sortimente auf Seite / Sets on Page
H 157, H 158

PROFESSIONAL PLUS STANDARD

Rollgabelschlüssel nach DIN 3117

Adjustable Wrenches

- ▶ Gabelstellung 15°
- ▶ Mit Skala an der Maul-Seite
- ▶ Open end position 15°
- ▶ With scale at the open end side



Art.-Nr./Art.-No.	Größe/Size	Länge/Length	max. Maulöffnung/max. Range	€
2404	4"	100 mm	13 mm	
2406	6"	150 mm	19 mm	
2408	8"	200 mm	24 mm	
2410	10"	250 mm	30 mm	
2412	12"	300 mm	34 mm	
2415	15"	375 mm	44 mm	

Schraubenschlüssel

Wrenches

NEU/NEW

Art.-Gruppe 123
Article Group 123

Automatischer Rollgabelschlüssel

Automatic Adjustable Wrenches

- ▶ **Selbständiges Anpassen an Schraubengrößen**
- ▶ **Automatisches Spannen durch entsprechende Drehbewegungen**
- ▶ **Integrierte Ratschenfunktion über Drehbewegung**
- ▶ **4 Größen passend für je 3 Schraubengrößen, metrisch und Zoll:**
8 – 10 / 11 – 13 / 14 – 16 / 17 – 19 mm
- ▶ **Auch passend für 4-kant, 12-kant, E-Torx**
- ▶ **Ideal für Sanitär und Automotive**

- ▶ *Automatic adjustment to screw sizes*
- ▶ *Automatic clamping by appropriate rotary motion*
- ▶ *Integrated ratchet function*
- ▶ *Every wrench fits to 3 screw sizes, metric and inch:*
8 – 10 / 11 – 13 / 14 – 16 / 17 – 19 mm
- ▶ *Also for square, 12-point, E-Torx*
- ▶ *Ideal for sanitary and automotive*

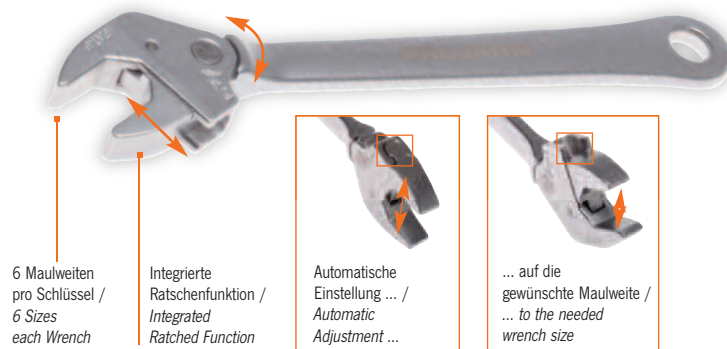

Art.-Nr./Art.-No.	Größe/Size	Länge/Length	€
2440810	8 - 9 - 10 mm + 5/16" - 11/32" - 3/8"	135 mm	
2441113	11 - 12 - 13 mm + 7/16" - 16/32" - 1/2"	155 mm	
2441416	14 - 15 - 16 - 16 mm + 9/16" - 19/32" - 5/8"	190 mm	
2441719	17 - 18 - 19 mm + 11/16" - 23/32" - 3/4"	210 mm	

Sortimente auf Seite / Sets on Page
H 159

Schraubenschlüssel

Wrenches

Art.-Gruppe 123
Article Group 123

PROFESSIONAL PLUS STANDARD

Gerüstbauerschlüssel, metrisch

Construction Wrenches, Metric

Das Ende des Handgriffs ist als Dorn ausgeführt und ermöglicht ein schnelles Justieren der Bauteile.

- ▶ Doppelseitige Knarre mit speziell gehärteten, durchgehenden Nüssen
- ▶ Langer Dorn zur optimalen Kraftübertragung

- ▶ Working with two sockets
- ▶ Sockets are extreme hard and with go-through-system



Art.-Nr./Art.-No.	Größe/Size	€	Art.-Nr./Art.-No.	Größe/Size	€
231013	10 x 13 mm		232427	24 x 27 mm	
231317	13 x 17 mm		232430	24 x 30 mm	
231719	17 x 19 mm		232732	27 x 32 mm	
231922	19 x 22 mm		233236	32 x 36 mm	
231924	19 x 24 mm				

PROFESSIONAL PLUS STANDARD

NEU/NEW

2319221

4-in-1 Gerüstbauerschlüssel mit Hammer und Nageleisen, 19 + 22 mm

4-in-1 Construction Wrench with Hammer and Nail Puller, 19 + 22 mm

- ▶ Mit ausgeschmiedetem Hammer und anklappbarem Nageleisen
- ▶ Größen 19 und 22 mm (in einem Schlüssel)
- ▶ Umschaltknarre, Spitzkegeldorn
- ▶ Langlebig aufgrund stabiler Ausführung

- ▶ With forged hammer and foldable nail puller
- ▶ Sizes 19 and 22 mm (in one wrench)
- ▶ Ratchet function, Taper Dorn
- ▶ Durable due to sturdy design

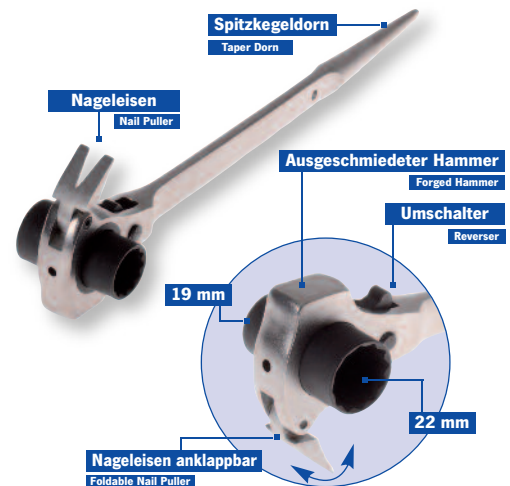

Art.-Nr./Art.-No.	Größe/Size	€
2319221	19 + 22 mm	

PROFESSIONAL PLUS STANDARD

Pfeifenkopfschlüssel mit Bohrung metrisch, 12-kant x 6-kant

Through-Hole Open-Socket Wrenches, 12 point x 6 point

- ▶ Kurze Seite mit 12-kant Nuss
- ▶ Lange Seite mit 6-kant Nuss
- ▶ Short side with 12 point socket
- ▶ Long side with 6 point socket



Art.-Nr./Art.-No.	Größe/Size	€	Art.-Nr./Art.-No.	Größe/Size	€	Art.-Nr./Art.-No.	Größe/Size	€	Art.-Nr./Art.-No.	Größe/Size	€
2588-08	8 mm		2588-14	14 mm		2588-20	20 mm		2588-26	26 mm	
2588-09	9 mm		2588-15	15 mm		2588-21	21 mm		2588-27	27 mm	
2588-10	10 mm		2588-16	16 mm		2588-22	22 mm		2588-28	28 mm	
2588-11	11 mm		2588-17	17 mm		2588-23	23 mm		2588-29	29 mm	
2588-12	12 mm		2588-18	18 mm		2588-24	24 mm		2588-30	30 mm	
2588-13	13 mm		2588-19	19 mm		2588-25	25 mm		2588-32	32 mm	

Ringgabelschlüssel Sätze

Combination Wrench Sets

Art-Gruppe 123
Article Group 123

PROFESSIONAL PLUS STANDARD

4421

Ringgabelschlüssel Satz, 8-teilig metrisch, nach DIN 3113 Form A, in Kartonverpackung inkl. Cliphalter

Combination Wrench Set, 8 pieces
Metric, Paper Box incl. Clip

8
tlg./pcs.

Inhalt/Contents:

je 1 Ringgabelschlüssel/Combination Wrench
8 - 9 - 10 - 11 - 13 - 14 - 17 - 19 mm

Art.-Nr./Art.-No.

4421 8-tlg./pcs.



PROFESSIONAL PLUS STANDARD

4422

Ringgabelschlüssel Satz 12-teilig metrisch, nach DIN 3113 Form A, in Kartonverpackung inkl. Cliphalter

Combination Wrench Set 12 pieces
Metric, Paper Box incl. Clip

12
tlg./pcs.

Inhalt/Contents:

je 1 Ringgabelschlüssel
6 - 7 - 8 - 9 - 10 - 11 - 12 - 13 - 14 - 15 - 17 - 19 mm

Art.-Nr./Art.-No.

4422 12-tlg./pcs.



PROFESSIONAL PLUS STANDARD

4408

Ringgabelschlüssel Satz, metrisch, nach DIN 3113 Form A, in Rolltasche

Combination Wrench Set
Metric, in Pouch

14
tlg./pcs.

Inhalt/Contents:

je 1 Ringgabelschlüssel
8 - 10 - 11 - 12 - 13 - 14 - 15 - 16 - 17 - 18 - 19 - 20 - 21 - 22 mm

Art.-Nr./Art.-No.

4408 14-tlg./pcs.
4408E Rolltasche leer/empty



Ringgabelschlüssel Sätze

Combination Wrench Sets

Art.-Gruppe 123
Article Group 123

PROFESSIONAL PLUS STANDARD

4410

**Ringgabelschlüssel Satz, metrisch
nach DIN 3113 Form A, in Rolltasche**

Combination Wrench Set,
Metric, in Pouch

23
tlg./pcs.

Inhalt/Contents:

je 1 Ringgabelschlüssel

6 - 7 - 8 - 9 - 10 - 11 - 12 - 13 - 14 - 15 - 16 - 17 - 18 - 19 - 20 - 21 - 22 -
24 - 25 - 26 - 27 - 30 - 32 mm

Art.-Nr./Art.-No.

€

4410 23-tlg./pcs.

4410E Rolltasche leer/Pouch empty



PROFESSIONAL PLUS STANDARD

4407

**Ringgabelschlüssel Satz, metrisch
nach DIN 3113 Form A, in Rolltasche**

Combination Wrench Set,
Metric, in Pouch

4
tlg./pcs.

Inhalt/Contents:

je 1 Ringgabelschlüssel

24 - 27 - 30 - 32 mm

Art.-Nr./Art.-No.

€

4407 4-tlg./pcs.

4407E Rolltasche leer/Pouch empty



PROFESSIONAL PLUS STANDARD

9961

**Ringgabelschlüssel Satz, metrisch
nach DIN 3113 Form A, in Rolltasche**

Combination Wrench Set,
Metric, in Pouch

14
tlg./pcs.

Inhalt/Contents:

je 1 Ringgabelschlüssel

6 - 7 - 8 - 9 - 10 - 11 - 12 - 13 - 14 - 15 - 16 - 17 - 18 - 19 mm

Art.-Nr./Art.-No.

€

9961 14-tlg./pcs.

3494E Rolltasche leer/Pouch empty



Ringgabelschlüssel Sätze lange Schlüssel

Combination Wrench Sets XL-Version

Art.-Gruppe 123
Article Group 123

PROFESSIONAL PLUS STANDARD

4436

Ringgabelschlüssel Satz, lange Schlüssel, metrisch, nach DIN 3113 Form A, in Rolltasche

Combination Wrench Set, XL, Metric, in Pouch

8
tlg./pcs.

Inhalt/Contents:

je 1 Ringgabelschlüssel
8 - 10 - 12 - 13 - 16 - 17 - 18 - 19 mm

Art.-Nr./Art.-No.	€
4436	8-tlg./pcs.
3499E	Rolltasche leer/Pouch empty



PROFESSIONAL PLUS STANDARD

4438

Ringgabelschlüssel Satz, lange Schlüssel, metrisch, nach DIN 3113 Form A, in Rolltasche

Combination Wrench Set, XL, Metric, in Pouch

14
tlg./pcs.

Inhalt/Contents:

je 1 Ringgabelschlüssel
8 - 10 - 11 - 12 - 13 - 14 - 15 - 16 - 17 - 18 - 19 - 20 - 21 - 22 mm

Art.-Nr./Art.-No.	€
4438	14-tlg./pcs.
4408E	Rolltasche leer/Pouch empty



PROFESSIONAL PLUS STANDARD

4437

Ringgabelschlüssel Satz, lange Schlüssel, metrisch, nach DIN 3113 Form A, in Rolltasche

Combination Wrench Set, XL, Metric, in Pouch

4
tlg./pcs.

Inhalt/Contents:

je 1 Ringgabelschlüssel 24 - 27 - 30 - 32 mm

Art.-Nr./Art.-No.	€
4437	4-tlg./pcs.
4407E	Rolltasche leer/Pouch empty



Ringgabelschlüssel Sätze

Combination Wrench Sets

Art.-Gruppe 123
Article Group 123

PROFESSIONAL PLUS STANDARD

2580

Ringgabelschlüssel Satz, Zoll, in Rolltasche

Combination Wrench Set,
Inch, in Pouch

Inhalt/Contents:

je 1 Ringgabelschlüssel

1/4" - 5/16" - 3/8" - 7/16" - 1/2" - 9/16" - 5/8" - 11/16" -
3/4" - 7/8" - 15/16" - 1"

12
tlg./pcs.



Art.-Nr./Art.-No.	€
2580	12-tlg./pcs.
2580E	Rolltasche, leer/Pouch empty

PROFESSIONAL PLUS STANDARD

NEU/NEW

4
tlg./pcs.

8
tlg./pcs.

4464 / 4466

DOLPHIN Ringgabelschlüssel-Satz, metrisch in Rolltasche 90° verdrehte Schlüsselanordnung ermöglicht 25% höhere Kraftübertragung

DOLPHIN Combination Wrench Set, metric in Pouch

90° twisted wrench arrangement allows 25% higher power transmission

4464 Inhalt/Contents: je 1 DOLPHIN Schlüssel 10 - 13 - 17 - 19 mm

4466 Inhalt/Contents: je 1 DOLPHIN Schlüssel 8 - 9 - 10 - 11 - 13 - 14 - 17 - 19 mm

Art.-Nr./Art.-No.	€
4464	4-tlg./pcs.
4466	8-tlg./pcs.



4466

4464

PROFESSIONAL PLUS STANDARD

NEU/NEW

4
tlg./pcs.

8
tlg./pcs.

4462 / 4463

CLICKTECH Ratschen-Ringgabelschlüssel-Satz, metrisch in Rolltasche

CLICKTECH Ratchet Combination Wrench Set,
metric in Pouch

4462 Inhalt/Contents: je 1 CLICKTECH Schlüssel 10 - 13 - 17 - 19 mm

4463 Inhalt/Contents: je 1 CLICKTECH Schlüssel 8 - 9 - 10 - 11 - 13 - 14 - 17 - 19 mm

Art.-Nr./Art.-No.	€
4462	4-tlg./pcs.
4463	8-tlg./pcs.

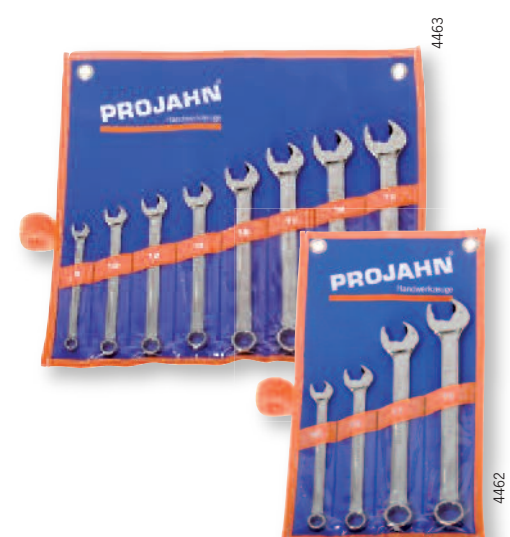

4463

4462

Doppelgabelschlüssel Sätze

Double Open End Wrench Sets

Art.-Gruppe 123
Article Group 123

PROFESSIONAL PLUS STANDARD

9988

Rohrsteckschlüssel Satz, leichte Ausführung in Rolltasche

Double Ended Socket Wrench Set,
Light Version in Pouch

10
tlg./pcs.

Inhalt/Contents:

je 1 Rohrsteckschlüssel

6x7 - 8x9 - 10x11 - 12x13 - 14x15 - 16x17 - 18x19 - 20x22,

Drehstift/tommy bar 146 mm (6 - 13 mm) + 146 mm (14 - 27mm)



Art.-Nr./Art.-No.

€

9988 10-tlg./pcs.

4405E Rolltasche, leer/Pouch empty

PROFESSIONAL PLUS STANDARD

4441

Doppelgabelschlüssel Satz, metrisch, nach DIN 3110, in Kartonverpackung inkl. Cliphalter

Double Open End Wrench Set,
Metric, Paper Box incl. Clip

6
tlg./pcs.

Inhalt/Contents:

je 1 Doppelgabelschlüssel

6 x 7 - 8 x 9 - 10 x 11 - 12 x 13 - 14 x 15 - 16 x 17 mm



Art.-Nr./Art.-No.

€

4441 6-tlg./pcs.

PROFESSIONAL PLUS STANDARD

4405

Doppelgabelschlüssel Satz, metrisch, nach DIN 3110, in Rolltasche

Double Open End Wrench Set,
Metric, in Pouch

8
tlg./pcs.

Inhalt/Contents:

je 1 Doppelgabelschlüssel

6 x 7 - 8 x 9 - 10 x 11 - 12 x 13 - 14 x 15 - 16 x 17 -
18 x 19 - 20 x 22 mm



Art.-Nr./Art.-No.

€

4405 8-tlg./pcs.

4405E Rolltasche leer/Pouch empty

Doppelringschlüssel Sätze / Offener Doppelringschlüssel Satz

Double Ring Wrench Sets / Flare Nut Wrench Set

Art.-Gruppe 123
Article Group 123

PROFESSIONAL PLUS STANDARD

4442

**Doppelgabelschlüssel Satz,
metrisch, nach DIN 3110,
in Kartonverpackung inkl. Cliphalter**

Double Open End Wrench Set,
Metric, Paper Box incl. Clip

8
tlg./pcs.

Inhalt/Contents:

je 1 Doppelgabelschlüssel 6 x 7 - 8 x 9 - 10 x 11 -
12 x 13 - 14 x 15 - 16 x 17 - 18 x 19 - 20 x 22 mm

Art.-Nr./Art.-No.

4442

8-tlg./pcs.



PROFESSIONAL PLUS STANDARD

4411

**Doppelgabelschlüssel Satz,
metrisch, nach DIN 3110, in Rolltasche**

Double Open End Wrench Set,
Metric, in Pouch

11
tlg./pcs.

Inhalt/Contents:

je 1 Doppelgabelschlüssel
6 x 7 - 8 x 9 - 10 x 11 - 12 x 13 - 14 x 15 - 16 x 17 - 18 x 19 -
20 x 22 - 21 x 23 - 24 x 27 - 30 x 32 mm

Art.-Nr./Art.-No.

4411

11-tlg./pcs.

4411E

Rolltasche leer/empty



PROFESSIONAL PLUS STANDARD

2216

**Offener Doppelringschlüssel Satz,
in Rolltasche**

Flare Nut Wrench Set,
Metric, in Pouch

6
tlg./pcs.

Inhalt/Contents:

je 1 Doppelringschlüssel
8 x 10 - 9 x 11 - 12 x 14 - 13 x 15 - 17 x 19 - 22 x 24 mm

Art.-Nr./Art.-No.

2216

6-tlg./pcs.

2216E

Rolltasche leer/empty



Doppelringschlüssel Sätze / Offener Doppelringschlüssel Satz

Double Ring Wrench Sets / Flare Nut Wrench Set

Art.-Gruppe 123
Article Group 123

PROFESSIONAL PLUS STANDARD

2218

Offener Doppelringschlüssel Satz, in Rolltasche

Flare Nut Wrench Set,
in Pouch

8
tlg./pcs.

Inhalt/Contents:

je 1 Doppelringschlüssel
9 x 11 - 10 x 12 - 13 x 15 - 14 x 17 mm
3/8" x 7/16" - 1/2" x 9/16" - 11/16" x 3/4" - 7/8" x 15/16"

Art.-Nr./Art.-No.	€
2218	8-tlg./pcs.
2218E	Rolltasche leer/empty



PROFESSIONAL PLUS STANDARD

4451

Doppelringschlüssel Satz, metrisch, nach DIN 838, in Kartonverpackung inkl. Cliphalter

Double Ring Wrench Set,
Metric, Paper Box incl. Clip

6
tlg./pcs.

Inhalt/Contents:

je 1 Doppelringschlüssel
6 x 7 - 8 x 9 - 10 x 11 - 12 x 13 - 14 x 15 - 16 x 17 mm

Art.-Nr./Art.-No.	€
4451	6-tlg./pcs.



PROFESSIONAL PLUS STANDARD

4402

Doppelringschlüssel Satz, metrisch, nach DIN 838, in Rolltasche

Double Ring Wrench Set,
Metric, in Pouch

8
tlg./pcs.

Inhalt/Contents:

je 1 Doppelringschlüssel
6 x 7 - 8 x 9 - 10 x 11 - 12 x 13 - 14 x 15 - 16 x 17 - 18 x 19 -
20 x 22 mm

Art.-Nr./Art.-No.	€
4402	8-tlg./pcs.
4402E	Rolltasche leer/empty



Doppelringschlüssel Sätze / Automatischer Rollgabelschlüssel Satz

Double Ring Wrench Sets / Automatic Adjustable Wrench Set

Art.-Gruppe 123
Article Group 123

PROFESSIONAL PLUS STANDARD

4452

**Doppelringschlüssel Satz,
metrisch, nach DIN 838,
in Kartonverpackung inkl. Cliphalter**

Double Ring Wrench Set,
Metric, Paper Box incl. Clip

Inhalt/Contents:

je 1 Doppelringschlüssel
6 x 7 - 8 x 9 - 10 x 11 - 12 x 13 - 14 x 15 - 16 x 17 -
18 x 19 - 20 x 22 mm

8
tlg./pcs.



Art.-Nr./Art.-No.

€

4452 8-tlg./pcs.

PROFESSIONAL PLUS STANDARD

4403

**Doppelringschlüssel Satz,
metrisch, nach DIN 838, in Rolltasche**

Double Ring Wrench Set,
Metric, in Pouch

Inhalt/Contents:

je 1 Doppelringschlüssel
21 x 23 - 24 x 27 - 25 x 28 - 30 x 32 mm

4
tlg./pcs.



Art.-Nr./Art.-No.

€

4403 4-tlg./pcs.

4403E Rolltasche leer/empty

PROFESSIONAL PLUS STANDARD

NEU/NEW

4468

**Automatischer Rollgabelschlüssel Satz,
in Rolltasche**

Automatic Adjustable Wrench Set,
in Pouch

Inhalt/Contents:

je 1 Automatischer Rollgabelschlüssel
8 - 9 - 10 mm + 5/16" - 11/32" - 3/8"
11 - 12 - 13 mm + 7/16" - 16/32" - 1/2"
14 - 15 - 16 mm + 9/16" - 19/32" - 5/8"
17 - 18 - 19 mm + 11/16" - 23/32" - 3/4"

4
tlg./pcs.



Art.-Nr./Art.-No.

€

4468 4-tlg./pcs.



Technische Daten

Technical Details

Vergleichsliste

Gewinde zu Schlüsselweite (SW) / Checklist Thread To Wrench Size

Gewinde/Thread (norm. Reihe)	SW/Size
M2	4
M2,5	5
M3	5,5
M4	7
M5	8
M6	10
M8	13
M10	17 (16)
M12	19 (18)
M14	21 (22)
M16	24
M18	27
M20	30
M22	32 (34)
M24	36
M27	41
M30	46
M33	50
M36	55
M39	60
M42	65
M45	70
M48	75
M52	80

Schlüsselweiten-Toleranzen

Auszug aus DIN 475 Teil 2/ Wrench Size Tolerances

Nennmaß/Nom. Dim.	min.	max.
3,5	3,52	3,60
4*	4,02	4,12
4,5	4,52	4,62
5*	5,02	5,12
5,5*	5,52	5,62
6*	6,03	6,15
7*	7,03	7,15
8*	8,03	8,15
9*	9,03	9,15
10*	10,04	10,19
11*	11,04	11,19
12*	12,04	12,24
13*	13,04	13,24
14*	14,05	14,27
15*	15,05	15,27
16*	16,05	16,27
17*	17,05	17,30
18*	18,05	18,30
19*	19,06	19,36
20*	20,06	20,36
21*	21,06	21,36
22*	22,06	22,36
23*	23,06	23,36
24*	24,06	24,36
25*	25,06	25,36
26*	26,08	26,48
27*	27,08	27,48
28*	28,08	28,48
30*	30,08	30,48
32*	32,08	32,48
34*	34,10	34,60
36*	36,10	36,60
41*	41,10	41,60
46*	46,10	46,60
50*	50,10	50,60
55*	55,12	55,72
60*	60,12	60,72
65*	65,12	65,72
70*	70,12	70,72
75*	75,15	75,85
80*	80,15	80,85

Umrechnungstabelle

Zoll zu Metrisch/ Conversion Table: Inch To Metric

Zoll/Inch	metrisch/metric (Ca.-Werte)
5/16"	7,938
3/8"	9,525
7/16"	11,113
1/2"	12,700
9/16"	14,288
5/8"	15,875
11/16"	17,463
3/4"	19,050
13/16"	20,638
7/8"	22,225
15/16"	23,813
1"	25,400
1 1/16"	26,987
1 1/8"	28,575
1 1/4"	31,750
1/64"	0,397
1/32"	0,794
3/64"	1,191
1/16"	1,588
5/64"	1,984
3/32"	2,381
1/8"	3,175
3/16"	4,763
1/4"	6,350
1 1/64"	25,797
1 1/32"	26,194
1 3/64"	26,591
1 5/64"	27,384
1 3/32"	27,781
1 3/16"	30,162
1 5/16"	33,337
1 3/8"	34,925
1 7/16"	36,512
1 1/2"	38,100
1 9/16"	39,687
1 5/8"	41,275
1 11/16"	42,862
1 3/4"	44,450
1 13/16"	46,037
1 7/8"	47,625
1 15/16"	49,212
2"	50,800
2 1/4"	57,150
2 1/2"	63,500
2 3/4"	69,850

Die durch * gekennzeichneten Schlüsselweiten entsprechen internationalen Normen. Die Schlüsselweiten 6, 9, 12, 14, 17, 19, 20, 22, 23, 25, 26, 28 und 32 sind in dem ISO/DIN 691 eingeklammert und als Übergangswerte bezeichnet.

*Wrench sizes marked by * correspond to international standards. The wrench sizes 6, 9, 12, 14, 17, 19, 20, 22, 23, 25, 26, 28 and 32 are bracketed in the ISO/DIN 691 and referred to as transitional values.*

Bit-Programm

Bits



1









Übersicht Bit-Boxen

Summary Bit Boxes

	Auf Seite / On Page	PROFESSIONAL	PLUS	STANDARD	Teile / Pieces	25 mm	75 mm	Schlitz / Slotted	Phillips / PH	Pozidriv / PZ	TORX® / TX	TORX® mit Bohrung / Tamper TORX®	Inbus/Hex	Inbus mit Bohrung / Tamper Hex	Robertson	Torq / Torq	Tri-Wing / Tri-Wing	Spanner / Spammer	Clutch / Clutch	Wielzahn / Spline	5-Stern mit Bohrung / 5-Star Tamper	Stecknuss Bits / Bit Sockets	Bit-Adapter / Bit Adapter	Eindreh-Bit für Haken / Hook Driver	Stecknuss-Adapter / Socket Adapter	(Mini) Bit-Knarre / (Mini) Ratchet Handle	Bit-Magnethalter / Magnetic Bit Holder	Magneth.-m. Schnellspannlüter / Magneth. Bit Holder Quick release	(Ratschen)Schraubendreher / (Ratchet) Screwdriver	Verkaufsdisplay / Display																	
NEU/NEU  1/4" KOMBI BIT Box / 1/4" KOMBI BIT Set Art.-Nr./Art.-No. 394074 B x L x H/W x L x H: 105 x 65 x 41 mm Gewicht/Weight: 270 g	H 181	+			31	+		+	+	+	+																																				
NEU/NEU  1/4" KOMBI BIT Box / 1/4" KOMBI BIT Set Art.-Nr./Art.-No. 394075 B x L x H/W x L x H: 105 x 65 x 41 mm Gewicht/Weight: 270 g	H 181	+			31	+		+	+	+	+																																				
 1/4" Allround-Bit Box / 1/4" Allround-Bit Set Art.-Nr./Art.-No. 4085 B x L x H/W x L x H: 115 x 95 x 32 mm Gewicht/Weight: 280 g	H 181	+			22	+		+	+	+	+											+	+																								
NEU/NEU  1/4" Stubby-Bit-Box / 1/4" Stubby Bit Set Art.-Nr./Art.-No. 394070 B x L x H/W x L x H: 115 x 80 x 45 mm Gewicht/Weight: 320 g	H 182	+			20	+		+	+	+	+																																				
NEU/NEU  1/4" Universal-Stubby-Bit-Box / 1/4" Universal Stubby Bit Set Art.-Nr./Art.-No. 394071 B x L x H/W x L x H: 115 x 80 x 45 mm Gewicht/Weight: 340 g	H 182	+			23	+		+	+	+	+																																				
NEU/NEU  1/4" Stubby-Ratschenschraubendreher / 1/4" Stubby Ratchet Screw Driver Art.-Nr./Art.-No. 4193 B x L x H/W x L x H: 95 x 38 x 38 mm Gewicht/Weight: 110 g	H 182	+			8	+		+	+	+	+																																				
 1/4" + 5/16" Kombi-Bit-Box / 1/4" + 5/16" Combi-Bit-Set Art.-Nr./Art.-No. 4092 B x L x H/W x L x H: 135 x 85 x 33 mm Gewicht/Weight: 510 g	H 183	+			32	+		+	+	+	+																																				
 1/4" Color-Bit-Box / 1/4" Color-Bit-Set Art.-Nr./Art.-No. 4091 B x L x H/W x L x H: 50 x 95 x 30 mm Gewicht/Weight: 140 g	H 184	+			15	+		+	+	+	+																																				
NEU/NEU  1/4" Color-Bit-Box / 1/4" Color-Bit-Set Art.-Nr./Art.-No. 394089 B x L x H/W x L x H: 96 x 65 x 40 mm Gewicht/Weight: 260 g	H 184	+			32	+		+	+	+	+																																				
 1/4" Color-Bit-Box / 1/4" Color-Bit-Set Art.-Nr./Art.-No. 4095 B x L x H/W x L x H: 125 x 70 x 35 mm Gewicht/Weight: 350 g	H 185	+			33	+		+	+	+	+																																				
 1/4" Color-Bit-Box XL / 1/4" Color-Bit-Set XL Art.-Nr./Art.-No. 4090 B x L x H/W x L x H: 155 x 120 x 35 mm Gewicht/Weight: 750 g	H 185	+			71	+		+	+	+	+																																				
 1/4" Color-Bit-Box 25 + 75 mm / 1/4" Color-Bit-Set 25 + 75 mm Art.-Nr./Art.-No. 4094 B x L x H/W x L x H: 127 x 95 x 34 mm Gewicht/Weight: 550 g	H 186	+			56	+		+	+	+	+																																				

Übersicht Bit-Boxen Summary Bit Boxes

2

Auf Seite / On Page	Qualität / Quality			Bit-Länge / Bit length		Antriebsart / Drive Type													Zubehör / Accessories										
	PROFESSIONAL	PLUS	STANDARD	Teile / Pieces	25 mm	75 mm	● Schlitz / Slotted	⊕ Phillips / PH	⊕ Pozidriv / PZ	⊕ TORX* / TX	⊕ TORX* mit Bohrung / Tamper TORX®	⊙ Inbus/Hex	⊙ Inbus mit Bohrung / Tamper Hex	⊙ Robertson	⊕ Torq / Torq	⊕ Tri-Wing / Tri-Wing	⊕ Spanner / Spanner	⊕ Clutch / Clutch	⊕ Vielzahn / Spline	⊕ 5-Stern mit Bohrung / 5-Star Tamper	Stecknuss Bits / Bit Sockets	Bit-Adapter / Bit Adapter	Eindreh-Bit für Haken / Hook Driver	Stecknuss-Adapter / Socket Adapter	Mini-Bit-Knarre / Mini Ratchet Handle	Bit-Magnethalter / Magnetic Bit Holder	Magnetth. m. Schweißspannhülse / Magnetic Bit Holder Quick release	(Ratschen-)Schraubendreher / (Ratchet) Screwdriver	Verkaufsdisplay / Display
 1/4" Color-Bit-Box mit Ratschenschraubendreher / 1/4" Color-Bit-Set incl. Ratchet Screwdriver Art.-Nr./Art.-No. 4097 B x L x H/W x L x H: 268 x 187 x 60 mm Gewicht/Weight: 1.250 g	H 186	+		60	+	+	+	+	+	+	+										+					+	+		
 1/4" Color-Bit-Box / 1/4" Color-Bit-Set Art.-Nr./Art.-No. 4093 B x L x H/W x L x H: 155 x 120 x 35 mm Gewicht/Weight: 490 g	H 187	+		18		+	+	+	+	+																			+
 1/4" Bit-Box mit Drehgriffknarre / 1/4" Bit Set with Twist Handle Ratchet Art.-Nr./Art.-No. 394073 B x L x H/W x L x H: 200 x 120 x 40 mm Gewicht/Weight: 620 g	H 187		+	32		+	+	+	+											+			+	+					
 1/4" SECURIBIT-Box / 1/4" SECURIBIT-Set Art.-Nr./Art.-No. 3790 B x L x H/W x L x H: 193 x 137 x 36 mm Gewicht/Weight: 900 g	H 188		+	50		+	+	+	+	+	+	+	+	+	+	+	+	+								+			
 1/4" Bit Box 75 mm / 1/4" Bit Set 75 mm Art.-Nr./Art.-No. 3788 B x L x H/W x L x H: 190 x 130 x 36 mm Gewicht/Weight: 720 g	H 188		+	36		+	+	+	+	+	+																+		
 1/4" SECURIBIT-Box / 1/4" SECURIBIT-Set Art.-Nr./Art.-No. 3789 B x L x H/W x L x H: 220 x 155 x 50 mm Gewicht/Weight: 1.160 g	H 189		+	122		+	+	+	+	+	+	+	+	+	+	+	+	+	+	+	+	+	+	+	+	+	+	+	+
 1/4" SECURIBIT-Box / 1/4" SECURIBIT-Set Art.-Nr./Art.-No. 3787 B x L x H/W x L x H: 190 x 130 x 36 mm Gewicht/Weight: 700 g	H 189		+	100		+	+	+	+	+	+	+	+	+	+	+	+	+			+	+	+			+			
 1/4" Bit Box XL / 1/4" Bit Set XL Art.-Nr./Art.-No. 8604 B x L x H/W x L x H: 120 x 205 x 45 mm Gewicht/Weight: 1.120 g	H 190		+	113		+	+	+	+	+	+															+	+		
 1/4" Bit Box XXL / 1/4" Bit Set XXL Art.-Nr./Art.-No. 8606 B x L x H/W x L x H: 335 x 200 x 45 mm Gewicht/Weight: 2.000 g	H 191		+	200		+	+	+	+	+	+	+	+	+	+	+	+	+	+			+			+	+			

Bit-Programm

Bit-Range



PROFESSIONAL PLUS STANDARD

PROFESSIONAL-Bits

- ▶ Höchste Passgenauigkeit und spezielle Härtung – sehr lange Lebensdauer und hochwertige Verschraubung
- ▶ Empfohlen für den professionellen Anwender
- ▶ Color-Ring-Bits, TiN-Bits, ACR-Bits, Diamant-Bits, Torsion-Bits
- ▶ Bester Rundlauf für ermüdungsfreies und schnelles Arbeiten
- ▶ Aus hochwertigstem S2-Spezialstahl gefertigt
- ▶ Große Auswahl an Einzelbits und Bitboxen

- ▶ *Best fitting accuracy and special hardening – gives extra long life and high class screw joint*
- ▶ *Recommended for professional use*
- ▶ *Color-Ring-Bits, TiN-Bits, ACR Bits, Diamant-Bits, Torsion-Bits*
- ▶ *Effortless and fast screwing*
- ▶ *Produced of high-performance S2-Steel*
- ▶ *Big product range of Bits and Bit-Boxes*



Color-Bits

- ▶ Dank Farbleitsystem immer schnell den richtigen Bit
- ▶ *Color ring helps to find the right bit easily*

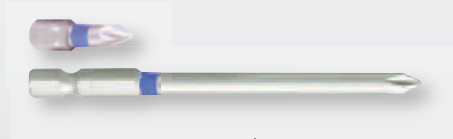

TiN-Bits

- ▶ Extrem harte Titan-Nitrit-Beschichtung – höhere Oberflächenhärte und Zähigkeit des Bits
- ▶ Weniger Verschleiß am Bit und weniger Schäden an Schraubenköpfen
- ▶ *Titan-Nitrite-Coating – higher surface hardness and resistance of the bits*
- ▶ *Less wear at the bit as well as damage at the screws*



ACR-Bits (Anti-Cam-Out-Ribs)

- ▶ Rippen an der Antriebsspitze reduzieren das Herausrutschen des Bits aus der Schraube
- ▶ Sauberes Verschraubungsergebnis u. weniger Verschleiß an Werkzeug u. Schraube
- ▶ *Rips at the tip of the bit reduce the risk of the “Cam-out-effect”*
- ▶ *High class work result*
- ▶ *Less wear at the tool and screw*



Diamant-Bits

- ▶ Mit Diamantpartikeln besetzte Antriebsspitze minimiert das Herausrutschen des Bits aus der Schraube
- ▶ Sicheres Verschrauben auf empfindlichen Oberflächen
- ▶ Ergonomischeres Arbeiten durch Reduzierung des Anpressdruckes
- ▶ Sauberes Verschraubungsergebnis und weniger Verschleiß
- ▶ *Diamond coated bit tip minimize the “Cam-out-effect”*
- ▶ *Safer screw driving on sensitive surfaces*
- ▶ *Less fatiguing work due to the reducing of contact pressure*
- ▶ *High class work result, less wear at the tool and screw*



Torsions-Bits

- ▶ Für höchste Belastung durch Hochleistungs-Spezialstahl ausgelegt
- ▶ Ideal für Schlagschrauber geeignet
- ▶ Spezielle Torsionszone leitet die Belastung der Bohrspitze in den Bit ab
- ▶ Reduzierung des Herausrutschens des Bits durch ACR-Profile
- ▶ *Produced of high-performance Steel – designed for maximum forces*
- ▶ *Especially suitable for use with impact drivers*
- ▶ *Special designed torsion zone absorbs forces into the bit*
- ▶ *Additional with Cam-out-rips*



PROFESSIONAL PLUS STANDARD

PLUS-Bits

- ▶ Erstklassiger Passsitz auf Grund sorgfältiger Verarbeitung auf modernen Produktionsanlagen
- ▶ Hervorragender Rundlauf für ermüdungsfreies und schnelles Arbeiten
- ▶ Aus hochwertigem S2-Spezialstahl gefertigt, ideal für den professionellen Anwender geeignet
- ▶ Breites Produktsortiment aus Einzelbits und Bitboxen – für jede Anwendung den richtigen Bit
- ▶ *Outstanding fit because of good workmanship on high technical machines*
- ▶ *Effortless and fast screwing*
- ▶ *Produced of S2-Steel, optimal for professional use*
- ▶ *Wide product range of Bits and Bit-Boxes – for every application the right bit*



PROFESSIONAL PLUS STANDARD

Standard-Bits

- ▶ Sehr guter Passsitz und Rundlauf für professionelle Einsätze
- ▶ Aus CR-V Stahl gefertigt
- ▶ Große Auswahl an Bit-Boxen

- ▶ *Good fit and concentricity for professional use*
- ▶ *Produced of CR-V steel*
- ▶ *Wide product range of Bit-Boxes*



1/4" BIT- Schraubendreher Einsätze

1/4" Bits



Art.-Gruppe 130
Article Group 130

PROFESSIONAL **PLUS** STANDARD

1/4" Schraubendreher-Einsätze für Kreuzschlitz-Schrauben Phillips

Phillips Bits



Art.-Nr./Art.-No. Größe/Size Länge/Length €

2701	PH 1	25 mm
2702	PH 2	25 mm
2703	PH 3	25 mm
2704	PH 4	25 mm
2801	PH 1	50 mm
2802	PH 2	50 mm
2803	PH 3	50 mm
2804	PH 4	50 mm
2901	PH 1	90 mm
2902	PH 2	90 mm
2903	PH 3	90 mm
2601	PH 1	150 mm
2602	PH 2	150 mm
2603	PH 3	150 mm
3002	PH 2	300 mm
2706	PH 2	extra schmal 25 mm
2707	2x PH 2	Tiefenstopp 25 mm
2708	PH 2	Tiefenstopp 25 mm

PROFESSIONAL **PLUS** STANDARD

3701	PH 1	TiN 25 mm
3702	PH 2	TiN 25 mm
3703	PH 3	TiN 25 mm

PROFESSIONAL **PLUS** STANDARD

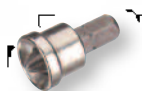

Art.-Nr./Art.-No. Größe/Size Länge/Length €

2707	2x PH 2	Tiefenstopp 25 mm
2708	PH 2	Tiefenstopp 25 mm

PROFESSIONAL **PLUS** STANDARD

1/4" ACR Schraubendreher-Einsätze für Kreuzschlitz-Schrauben Phillips

ACR Phillips Bits



10er Pack ACR Bits

10 pcs Box ACR Bits

Art.-Nr./Art.-No. Größe/Size Länge/Length €

3001-10	PH 1	25 mm
3002-10	PH 2	25 mm
3003-10	PH 3	25 mm
3101-10	PH 1	50 mm
3102-10	PH 2	50 mm
3103-10	PH 3	50 mm

PROFESSIONAL **PLUS** STANDARD

ACR Bits lose

ACR Bits Bulk

Art.-Nr./Art.-No. Größe/Size Länge/Length €

3201	PH 1	70 mm
3202	PH 2	70 mm
3203	PH 3	70 mm

PROFESSIONAL **PLUS** STANDARD

1/4" Schraubendreher-Einsätze 100er Pack für Kreuzschlitz-Schrauben Phillips

Phillips Bits 100 pcs Box



Art.-Nr./Art.-No. Größe/Size Länge/Length €

2701-100	PH 1	25 mm
2702-100	PH 2	25 mm
2703-100	PH 3	25 mm

PROFESSIONAL **PLUS** STANDARD

1/4" Schraubendreher-Einsätze 10er Pack für Kreuzschlitz-Schrauben Phillips

Phillips Bits

10pcs Box



Art.-Nr./Art.-No. Größe/Size Länge/Length €

2700-10	PH 0	25 mm
2701-10	PH 1	25 mm
2702-10	PH 2	25 mm
2703-10	PH 3	25 mm
2704-10	PH 4	25 mm
2801-10	PH 1	50 mm
2802-10	PH 2	50 mm
2803-10	PH 3	50 mm

PROFESSIONAL **PLUS** STANDARD

Extra schmal
Reduced Nose



Art.-Nr./Art.-No. Größe/Size Länge/Length €

2706	PH 2	extra schmal 25 mm
------	------	--------------------

1/4" BIT- Schraubendreher Einsätze

1/4" Bits



Art.-Gruppe 130
Article Group 130

PROFESSIONAL PLUS STANDARD

1/4" Schraubendreher-Einsätze für Kreuzschlitz-Schrauben Pozidriv

Pozidriv Bits



Art.-Nr./Art.-No.	Größe/Size	Länge/Length	€
2711	PZ 1	25 mm	
2712	PZ 2	25 mm	
2713	PZ 3	25 mm	
2714	PZ 4	25 mm	
2811	PZ 1	50 mm	
2812	PZ 2	50 mm	
2813	PZ 3	50 mm	
2814	PZ 4	50 mm	
2911	PZ 1	90 mm	
2912	PZ 2	90 mm	
2913	PZ 3	90 mm	
2611	PZ 1	150 mm	
2612	PZ 2	150 mm	
2613	PZ 3	150 mm	
3012	PZ 2	300 mm	

PROFESSIONAL PLUS STANDARD

3711	PZ 1	TiN 25 mm	
3712	PZ 2	TiN 25 mm	
3713	PZ 3	TiN 25 mm	

PROFESSIONAL PLUS STANDARD

1/4" ACR Schraubendreher-Einsätze für Kreuzschlitz-Schrauben Pozidriv

ACR Pozidriv Bits



10er Pack ACR Bits

10pcs Box ACR Bits



Art.-Nr./Art.-No.	Größe/Size	Länge/Length	€
3011-10	PZ 1	25 mm	
3012-10	PZ 2	25 mm	
3013-10	PZ 3	25 mm	
3111-10	PZ 1	50 mm	
3112-10	PZ 2	50 mm	
3113-10	PZ 3	50 mm	

PROFESSIONAL PLUS STANDARD

1/4" ACR Bits lose

ACR Bits Bulk

Art.-Nr./Art.-No.	Größe/Size	Länge/Length	€
3211	PZ 1	70 mm	
3212	PZ 2	70 mm	
3213	PZ 3	70 mm	

PROFESSIONAL PLUS STANDARD

1/4" Schraubendreher-Einsätze 10er Pack für Kreuzschlitz-Schrauben Pozidriv

Pozidriv Bits 10pcs Box



Art.-Nr./Art.-No.	Größe/Size	Länge/Length	€
2710-10	PZ 0	25 mm	
2711-10	PZ 1	25 mm	
2712-10	PZ 2	25 mm	
2713-10	PZ 3	25 mm	
2714-10	PZ 4	25 mm	
2811-10	PZ 1	50 mm	
2812-10	PZ 2	50 mm	
2813-10	PZ 3	50 mm	

PROFESSIONAL PLUS STANDARD

1/4" Schraubendreher-Einsätze 100er Pack für Kreuzschlitz-Schrauben Pozidriv

Pozidriv Bits 100 pcs Box



Art.-Nr./Art.-No.	Größe/Size	Länge/Length	€
2711-100	PZ 1	25 mm	
2712-100	PZ 2	25 mm	
2713-100	PZ 3	25 mm	

1/4" BIT- Schraubendreher Einsätze

1/4" Bits



Art-Gruppe 130
Article Group 130

PROFESSIONAL **PLUS** STANDARD

1/4" Schraubendreher-Einsätze für Schlitz-Schrauben

Slotted Bits



Art.-Nr./Art.-No.	Größe/Size	Länge/Length	€
2721	4,0 mm	25 mm	
2722	4,5 mm	25 mm	
2727	5,0 mm	25 mm	
2723	5,5 mm	25 mm	
2724	6,0 mm	25 mm	
2725	6,5 mm	25 mm	
2726	8,0 mm	25 mm	
2821	4,0 mm	50 mm	
2822	4,5 mm	50 mm	
2823	5,5 mm	50 mm	
2824	6,0 mm	50 mm	
2825	6,5 mm	50 mm	
2826	8,0 mm	50 mm	
3221	4,0 mm	70 mm	
3222	4,5 mm	70 mm	
3223	5,5 mm	70 mm	
3224	6,0 mm	70 mm	
3225	6,5 mm	70 mm	
3226	8,0 mm	70 mm	
2921	4,0 mm	90 mm	
2922	4,5 mm	90 mm	
2923	5,5 mm	90 mm	
2924	6,0 mm	90 mm	
2925	6,5 mm	90 mm	
2926	8,0 mm	90 mm	

PROFESSIONAL **PLUS** STANDARD

1/4" Schraubendreher-Einsätze 10er Pack für Schlitz-Schrauben

Slotted Bits 10 pcs Box



Art.-Nr./Art.-No.	Größe/Size	Länge/Length	€
2721-10	4,0 mm	25 mm	
2722-10	4,5 mm	25 mm	
2723-10	5,5 mm	25 mm	
2724-10	6,0 mm	25 mm	
2725-10	6,5 mm	25 mm	
2726-10	8,0 mm	25 mm	

1/4" BIT- Schraubendreher Einsätze

1/4" Bits



Art.-Gruppe 130
Article Group 130

PROFESSIONAL PLUS STANDARD

1/4" Schraubendreher-Einsätze für Innen-TX-Schrauben

TX Bits



Art.-Nr./Art.-No.	Größe/Size	Länge/Length	€
2728	T6	25 mm	
2729	T7	25 mm	
2738	T8	25 mm	
2739	T9	25 mm	
2731	T10	25 mm	
2732	T15	25 mm	
2733	T20	25 mm	
2734	T25	25 mm	
2737	T27	25 mm	
2735	T30	25 mm	
2736	T40	25 mm	
2831	T10	50 mm	
2832	T15	50 mm	
2833	T20	50 mm	
2834	T25	50 mm	
2837	T27	50 mm	
2835	T30	50 mm	
2836	T40	50 mm	
3228	T6	70 mm	
3229	T7	70 mm	
3238	T8	70 mm	
3239	T9	70 mm	
3231	T10	70 mm	
3232	T15	70 mm	
3233	T20	70 mm	
3234	T25	70 mm	
3237	T27	70 mm	
3235	T30	70 mm	
3236	T40	70 mm	
3274	T45	70 mm	
3275	T50	70 mm	

Art.-Nr./Art.-No.	Größe/Size	Länge/Length	€
2931	T10	90 mm	
2932	T15	90 mm	
2933	T20	90 mm	
2934	T25	90 mm	
2937	T27	90 mm	
2935	T30	90 mm	
2936	T40	90 mm	
2631	T10	150 mm	
2632	T15	150 mm	
2633	T20	150 mm	
2634	T25	150 mm	
2637	T27	150 mm	
2635	T30	150 mm	
2636	T40	150 mm	
3031	T10	300 mm	
3032	T15	300 mm	
3033	T20	300 mm	
3034	T25	300 mm	
3035	T30	300 mm	
3036	T40	300 mm	
PROFESSIONAL PLUS STANDARD			
3731	T10	TiN 25 mm	
3732	T15	TiN 25 mm	
3733	T20	TiN 25 mm	
3734	T25	TiN 25 mm	
3737	T27	TiN 25 mm	
3735	T30	TiN 25 mm	
3736	T40	TiN 25 mm	

PROFESSIONAL PLUS STANDARD

1/4" Konische Schraubendreher-Einsätze 10er Pack für Innen-TX-Schrauben

1/4" TX Align-Tapered Bits



Die Bits laufen konisch zu, werden in die Schraube gedrückt und sind somit fest mit der Schraube verbunden.

The bit will fix in the screw and so the screw would not get loose.

Art.-Nr./Art.-No.	Größe/Size	Länge/Length	€
3030-10	T6W	25 mm	
3031-10	T7W	25 mm	
3032-10	T8W	25 mm	
3033-10	T9W	25 mm	
3034-10	T10W	25 mm	
3035-10	T15W	25 mm	
3036-10	T20W	25 mm	
3037-10	T25W	25 mm	
3038-10	T27W	25 mm	
3039-10	T30W	25 mm	
3040-10	T40W	25 mm	
3130-10	T6W	50 mm	
3131-10	T7W	50 mm	
3132-10	T8W	50 mm	
3133-10	T9W	50 mm	
3134-10	T10W	50 mm	
3135-10	T15W	50 mm	
3136-10	T20W	50 mm	
3137-10	T25W	50 mm	
3138-10	T27W	50 mm	
3139-10	T30W	50 mm	
3140-10	T40W	50 mm	

1/4" BIT- Schraubendreher Einsätze

1/4" Bits



Art.-Gruppe 130
Article Group 130

PROFESSIONAL PLUS STANDARD

1/4" Schraubendreher-Einsätze 10er Pack für Innen-TX-Schrauben

TX Bits 10 pcs Box



PROFESSIONAL PLUS STANDARD

1/4" Schraubendreher-Einsätze 100er Pack für Innen-TX-Schrauben

TX Bits 100 pcs Box



PROFESSIONAL PLUS STANDARD

1/4" Schraubendreher-Einsätze für Innen-TX-Schrauben mit stirnseitiger Bohrung

Tamper TX Bits



Art.-Nr./Art.-No. Größe/Size Länge/Length €

2727-10	T5	25 mm
2728-10	T6	25 mm
2729-10	T7	25 mm
2738-10	T8	25 mm
2739-10	T9	25 mm
2731-10	T10	25 mm
2732-10	T15	25 mm
2733-10	T20	25 mm
2734-10	T25	25 mm
2737-10	T27	25 mm
2735-10	T30	25 mm
2736-10	T40	25 mm
2771-10	T45	25 mm
2772-10	T50	25 mm

2831-10	T10	50 mm
2832-10	T15	50 mm
2833-10	T20	50 mm
2834-10	T25	50 mm
2837-10	T27	50 mm
2835-10	T30	50 mm
2836-10	T40	50 mm
2774-10	T45	50 mm
2775-10	T50	50 mm

Art.-Nr./Art.-No. Größe/Size Länge/Length €

2731-100	T10	25 mm
2732-100	T15	25 mm
2733-100	T20	25 mm
2734-100	T25	25 mm
2735-100	T30	25 mm
2736-100	T40	25 mm

PROFESSIONAL PLUS STANDARD

1/4" 5-Stern Schraubendreher-Einsätze mit stirnseitiger Bohrung

5-star Tamper Bits



Art.-Nr./Art.-No. Größe/Size Länge/Length €

2881	TS10	25 mm
2882	TS15	25 mm
2883	TS20	25 mm
2884	TS25	25 mm
2885	TS27	25 mm
2886	TS30	25 mm
2887	TS40	25 mm

Art.-Nr./Art.-No. Größe/Size Länge/Length €

2747	T7	25 mm
2748	T8	25 mm
2749	T9	25 mm
2751	T10	25 mm
2752	T15	25 mm
2753	T20	25 mm
2754	T25	25 mm
2755	T27	25 mm
2756	T30	25 mm
2757	T40	25 mm

2777-10	T45 (10er Pack)	25 mm
---------	-----------------	-------

2778-10	T50 (10er Pack)	25 mm
---------	-----------------	-------

2851	T10	50 mm
2852	T15	50 mm
2853	T20	50 mm
2854	T25	50 mm
2855	T27	50 mm
2856	T30	50 mm
2857	T40	50 mm

2961	T10	90 mm
2962	T15	90 mm
2963	T20	90 mm
2964	T25	90 mm

2758	Set T10-T40/7-tlg.	25 mm
------	--------------------	-------

1/4" BIT- Schraubendreher Einsätze

1/4" Bits



Art.-Gruppe 130
Article Group 130

PROFESSIONAL **PLUS** STANDARD

1/4" Schraubendreher-Einsätze für Innensechskant-Schrauben

Hex Bits



Art.-Nr./Art.-No.	Größe/Size	Länge/Length	€
2696	1,5 mm	25 mm	
2697	2,0 mm	25 mm	
2698	2,5 mm	25 mm	
2741	3,0 mm	25 mm	
2742	4,0 mm	25 mm	
2743	5,0 mm	25 mm	
2699	5,5 mm	25 mm	
2744	6,0 mm	25 mm	
2745	7,0 mm	25 mm	
2746	8,0 mm	25 mm	
2841	3,0 mm	50 mm	
2842	4,0 mm	50 mm	
2843	5,0 mm	50 mm	
2844	6,0 mm	50 mm	
2845	7,0 mm	50 mm	
2846	8,0 mm	50 mm	
3247	1,5 mm	70 mm	
3248	2,0 mm	70 mm	
3249	2,5 mm	70 mm	
3241	3,0 mm	70 mm	
3242	4,0 mm	70 mm	
3243	5,0 mm	70 mm	
3041	3,0 mm	300 mm	
3042	4,0 mm	300 mm	
3043	5,0 mm	300 mm	
3044	6,0 mm	300 mm	
3045	7,0 mm	300 mm	
3046	8,0 mm	300 mm	
3093	5/32"	300 mm	
3094	9/64"	300 mm	
3095	1/8"	300 mm	
3096	7/64"	300 mm	
3097	3/32"	300 mm	
3098	5/64"	300 mm	

PROFESSIONAL **PLUS** STANDARD

1/4" Schraubendreher-Einsätze 10er Pack für Innensechskant-Schrauben

Hex Bits 10 pcs Box



Art.-Nr./Art.-No.	Größe/Size	Länge/Length	€
2741-10	3,0 mm	25 mm	
2742-10	4,0 mm	25 mm	
2743-10	5,0 mm	25 mm	
2744-10	6,0 mm	25 mm	
2745-10	7,0 mm	25 mm	
2746-10	8,0 mm	25 mm	

PROFESSIONAL **PLUS** STANDARD

1/4" Schraubendreher-Einsätze für Innensechskant-Schrauben mit stirnseitiger Bohrung

Tamper Hex Bits



Art.-Nr./Art.-No.	Größe/Size	Länge/Length	€
2676	2,0 mm	25 mm	
2677	2,5 mm	25 mm	
2678	3,0 mm	25 mm	
2679	4,0 mm	25 mm	
2680	5,0 mm	25 mm	
2681	6,0 mm	25 mm	
2683	5/32"	25 mm	
2684	9/64"	25 mm	
2685	1/8"	25 mm	
2686	7/64"	25 mm	
2687	3/32"	25 mm	
2688	5/64"	25 mm	

PROFESSIONAL **PLUS** STANDARD

1/4" Schraubendreher-Einsätze mit Kugelkopf 10er Pack für Innensechskant-Schrauben

Ball Point Bits 10 pcs Box



Art.-Nr./Art.-No.	Größe/Size	Länge/Length	€
2780-10	1,5 mm	25 mm	
2781-10	2,0 mm	25 mm	
2782-10	2,5 mm	25 mm	
2783-10	3,0 mm	25 mm	
2784-10	4,0 mm	25 mm	
2785-10	5,0 mm	25 mm	
2786-10	6,0 mm	25 mm	
2787-10	7,0 mm	25 mm	
2788-10	8,0 mm	25 mm	

1/4" BIT- Schraubendreher Einsätze 300 mm

1/4" Bits 300 mm



Art.-Gruppe 130
Article Group 130



Extra lange Ausführung

Extra long Version

PROFESSIONAL PLUS STANDARD

1/4" Schraubendreher-Einsätze für Kreuzschlitz-Schrauben Phillips
Phillips Bits



Art.-Nr./Art.-No.	Größe/Size	Länge/Length	€
3002	PH 2	300 mm	

PROFESSIONAL PLUS STANDARD

1/4" Schraubendreher-Einsätze für Kreuzschlitz-Schrauben Pozidriv
Pozidriv Bits



Art.-Nr./Art.-No.	Größe/Size	Länge/Length	€
3012	PZ 2	300 mm	

PROFESSIONAL PLUS STANDARD

1/4" Schraubendreher-Einsätze für Innen-TX-Schrauben
TX Bits



Art.-Nr./Art.-No.	Größe/Size	Länge/Length	€
3031	T10	300 mm	
3032	T15	300 mm	
3033	T20	300 mm	
3034	T25	300 mm	
3035	T30	300 mm	
3036	T40	300 mm	

PROFESSIONAL PLUS STANDARD

1/4" Schraubendreher-Einsätze für Innensechskant-Schrauben
Hex Bits



Art.-Nr./Art.-No.	Größe/Size	Länge/Length	€
3041	3,0 mm	300 mm	
3042	4,0 mm	300 mm	
3043	5,0 mm	300 mm	
3044	6,0 mm	300 mm	
3045	7,0 mm	300 mm	
3046	8,0 mm	300 mm	
3093	5/32"	300 mm	
3094	9/64"	300 mm	
3095	1/8"	300 mm	
3096	7/64"	300 mm	
3097	3/32"	300 mm	
3098	5/64"	300 mm	

Bit-Display / Magazin

Bit Display / Storage



Fragen Sie nach unseren Bestückungen – das Display kann auch individuell nach Kundenwunsch bestückt werden!

Please ask for different contents – the display content can be individualised due to your needs!

Art.-Gruppe 131
Article Group 131

11911-01

615 x 503 x 150 mm

Reihe 1/Line 1:

- ⊕ 25 mm 30 x PH1 - 50 x PH2 - 30 x PH3
- ⊕ 25 mm TiN 20 x PH1 - 30 x PH2 - 20 x PH3
- ⊕ 50 mm 20 x PH2
- ⊕ 25 mm 10 x Schraubvorsatz mit Tiefenstopp PH 2
- 50 mm Stecknuss Bit Adapter 1/4" x 1/4"

Reihe 2/Line 2:

- ⊕ 25 mm 30 x PZ1 - 50 x PZ2 - 30 x PZ3
- ⊕ 25 mm TiN 20 x PZ1 - 30 x PZ2 - 20 x PZ3
- ⊕ 50 mm 10 x PZ1 - 20 x PZ2 - 10 x PZ3

Reihe 3/Line 3:

- ⊕ 25 mm 20 x TX10 - 20 x TX15 - 50 x TX20 - 50 x TX 25 - 50 x TX30 - 20 x TX 40
- ⊕ 25 mm TiN 30 x TX15 - 30 x TX 20 - 30 x TX 25

Reihe 4/Line 4:

- 65 mm Stecknuss Bit 6 x 8 mm - 6 x 10 mm - 5 x 13 mm
- 10 x Bit Magnethalter
- 10 x Magnethalter mit Schnellspannfutter
- 10 x Magnethalter mit „Ring-Magnet“

Art.-Nr./Art.-No.	tlg./pcs.	€
11911-01	787 bestückt mit 787 Bits / with 787 Bits	

1/4" Color-BIT-Schraubendreher Einsätze 25 + 75 mm

1/4" Color-Bits 25 + 75 mm



NEU/NEW

Art.-Gruppe 132
Article Group 132



1/4" Color-BIT-Schraubendreher-Einsätze, für Kreuzschlitz-Schrauben Phillips, 3er-Pack

Phillips Color-Bits, 3 pcs Box



Art.-Nr./Art.-No.	Größe/Size	Länge/Length	€
1701-03	PH 1	25 mm	
1702-03	PH 2	25 mm	
1703-03	PH 3	25 mm	

1801-03	PH 1	75 mm	
1802-03	PH 2	75 mm	
1803-03	PH 3	75 mm	

1/4" Color-BIT-Schraubendreher-Einsätze, für Kreuzschlitz-Schrauben Phillips, 10er-Pack

Phillips Color-Bits, 10 pcs Box



Art.-Nr./Art.-No.	Größe/Size	Länge/Length	€
1701-10	PH 1	25 mm	
1702-10	PH 2	25 mm	
1703-10	PH 3	25 mm	

1/4" Color-BIT-Schraubendreher-Einsätze, für Kreuzschlitz-Schrauben Phillips, 50er Pack

Phillips Color-Bits, 50 pcs Box



Art.-Nr./Art.-No.	Größe/Size	Länge/Length	€
1701-50	PH 1	25 mm	
1702-50	PH 2	25 mm	

1/4" Color-BIT-Schraubendreher-Einsätze, für Schlitz-Schrauben, 3er-Pack

Slotted Color-Bits, 3 pcs Box



Art.-Nr./Art.-No.	Größe/Size	Länge/Length	€
1721-03	3 mm	25 mm	
1722-03	4 mm	25 mm	
1723-03	5 mm	25 mm	
1724-03	6 mm	25 mm	

1822-03	4 mm	75 mm	
1824-03	6 mm	75 mm	

1/4" Color-BIT-Schraubendreher-Einsätze, für Pozidriv-Schrauben Pozidriv, 3er-Pack

Pozidriv Color-Bits, 3 pcs Box



Art.-Nr./Art.-No.	Größe/Size	Länge/Length	€
1711-03	PZ 1	25 mm	
1712-03	PZ 2	25 mm	
1713-03	PZ 3	25 mm	

1811-03	PZ 1	75 mm	
1812-03	PZ 2	75 mm	
1813-03	PZ 3	75 mm	

1/4" Color-BIT-Schraubendreher-Einsätze, für Pozidriv-Schrauben Pozidriv, 10er-Pack

Pozidriv Color-Bits, 10 pcs Box



Art.-Nr./Art.-No.	Größe/Size	Länge/Length	€
1711-10	PZ 1	25 mm	
1712-10	PZ 2	25 mm	
1713-10	PZ 3	25 mm	

1/4" Color-BIT-Schraubendreher-Einsätze, für Pozidriv-Schrauben Pozidriv, 50er-Pack

Pozidriv Color-Bits, 50 pcs Box



Art.-Nr./Art.-No.	Größe/Size	Länge/Length	€
1711-50	PZ 1	25 mm	
1712-50	PZ 2	25 mm	



Bits 25 mm
10er-Pack/10 pcs Box

Bits 25 mm
50er-Pack/50 pcs Box

1/4" Color-BIT-Schraubendreher Einsätze 25 + 75 mm

1/4" Color-Bits 25 + 75 mm



NEU/NEW

Art.-Gruppe 132
Article Group 132



NEU/NEW

NEU/NEW

Bits 25 mm
3er-Pack /
3 pcs Box



Bits 25 mm
10er-Pack /
10 pcs Box



Bits 25 mm
50er-Pack /
50 pcs Box



Bits 75 mm
3er-Pack /
3 pcs Box



1/4" Color-BIT-Schraubendreher-Einsätze, für TX-Schrauben TORX®, 3er-Pack

TORX® Color-Bits, 3 pcs Box



Art.-Nr./Art.-No.	Größe/Size	Länge/Length	€
1731-03	TX 10	25 mm	
1732-03	TX 15	25 mm	
1733-03	TX 20	25 mm	
1734-03	TX 25	25 mm	
1735-03	TX 27	25 mm	
1736-03	TX 30	25 mm	
1737-03	TX 40	25 mm	

1831-03	TX 10	75 mm	
1832-03	TX 15	75 mm	
1833-03	TX 20	75 mm	
1834-03	TX 25	75 mm	
1835-03	TX 27	75 mm	
1836-03	TX 30	75 mm	
1837-03	TX 40	75 mm	

1/4" Color-BIT-Schraubendreher-Einsätze, für TX-Schrauben TORX®, 10er-Pack

TORX® Color-Bits, 10 pcs Box



Art.-Nr./Art.-No.	Größe/Size	Länge/Length	€
1731-10	TX 10	25 mm	
1732-10	TX 15	25 mm	
1733-10	TX 20	25 mm	
1734-10	TX 25	25 mm	
1735-10	TX 27	25 mm	
1736-10	TX 30	25 mm	
1737-10	TX 40	25 mm	

1/4" Color-BIT-Schraubendreher-Einsätze, für TX-Schrauben TORX®, 50er-Pack

TORX® Color-Bits, 50 pcs Box



Art.-Nr./Art.-No.	Größe/Size	Länge/Length	€
1731-50	TX 10	25 mm	
1732-50	TX 15	25 mm	
1733-50	TX 20	25 mm	
1734-50	TX 25	25 mm	
1736-50	TX 30	25 mm	

1/4" Color-BIT-Schraubendreher-Einsätze, für TX-Schrauben mit Bohrung Tamper TORX®, 3er-Pack

Tamper TORX® Color-Bits, 3 pcs Box



Art.-Nr./Art.-No.	Größe/Size	Länge/Length	€
1751-03	Tamper TX 10	25 mm	
1752-03	Tamper TX 15	25 mm	
1753-03	Tamper TX 20	25 mm	
1754-03	Tamper TX 25	25 mm	
1755-03	Tamper TX 27	25 mm	
1756-03	Tamper TX 30	25 mm	
1757-03	Tamper TX 40	25 mm	

1/4" Color-BIT-Schraubendreher-Einsätze, für Sechskant-Schrauben, Inbus, 3er-Pack

Hex Color-Bits, 3 pcs Box



Art.-Nr./Art.-No.	Größe/Size	Länge/Length	€
1741-03	Hex 3	25 mm	
1742-03	Hex 4	25 mm	
1743-03	Hex 5	25 mm	
1744-03	Hex 6	25 mm	
1841-03	Hex 3	75 mm	
1842-03	Hex 4	75 mm	
1843-03	Hex 5	75 mm	

1/4" Color-BIT-Schraubendreher-Einsätze, für Sechskant-Schrauben, Inbus, 10er-Pack

Hex Color-Bits, 10 pcs Box



Art.-Nr./Art.-No.	Größe/Size	Länge/Length	€
1742-10	Hex 4	25 mm	
1743-10	Hex 5	25 mm	



Bits 25 mm
10er-Pack/10 pcs Box

Bits 25 mm
50er-Pack/50 pcs Box

1/4" BIT-Schraubendreher Einsätze, diamantbeschichtet*

1/4" Bits, Diamond Coating*



Art.-Gruppe 130
Article Group 130

1/4" BIT-Schraubendreher-Einsätze, diamantbeschichtet für Kreuzschlitz-Schrauben Phillips, 3er-Pack

Phillips Bits, Diamond Coating, 3 pcs Box



Art.-Nr./Art.-No.	Größe/Size	Länge/Length	€
1750001-03	PH 1	25 mm	
1750002-03	PH 2	25 mm	
1750003-03	PH 3	25 mm	
1751001-03	PH 1	50 mm	
1751002-03	PH 2	50 mm	
1751003-03	PH 3	50 mm	

1/4" BIT-Schraubendreher-Einsätze, diamantbeschichtet für Schlitz-Schrauben, 3er-Pack

Slotted Bits, Diamond Coating, 3 pcs Box



Art.-Nr./Art.-No.	Größe/Size	Länge/Length	€
1750202-03	4,0 mm	25 mm	
1750203-03	4,5 mm	25 mm	
1750204-03	5,5 mm	25 mm	
1751202-03	4,0 mm	50 mm	
1751203-03	4,5 mm	50 mm	
1751204-03	5,5 mm	50 mm	

1/4" BIT-Schraubendreher-Einsätze, diamantbeschichtet für Innen-TX-Schrauben, 3er-Pack

TX Bits, Diamond Coating, 3 pcs Box



Art.-Nr./Art.-No.	Größe/Size	Länge/Length	€
1750310-03	T10	25 mm	
1750315-03	T15	25 mm	
1750320-03	T20	25 mm	
1750325-03	T25	25 mm	
1750330-03	T30	25 mm	
1751310-03	T10	50 mm	
1751315-03	T15	50 mm	
1751320-03	T20	50 mm	
1751325-03	T25	50 mm	
1751330-03	T30	50 mm	

1/4" BIT-Schraubendreher-Einsätze, diamantbeschichtet für Kreuzschlitz-Schrauben Pozidriv, 3er-Pack

Pozidriv Bits, Diamond Coating, 3 pcs Box



Art.-Nr./Art.-No.	Größe/Size	Länge/Length	€
1750101-03	PZ 1	25 mm	
1750102-03	PZ 2	25 mm	
1750103-03	PZ 3	25 mm	
1751101-03	PZ 1	50 mm	
1751102-03	PZ 2	50 mm	
1751103-03	PZ 3	50 mm	

Diamantbeschichtete Bit-Schraubendreher-Einsätze

Diamond Coated Bits

- ▶ Mit Diamantpartikeln besetzte Antriebsspitze minimiert das Herausrutschen des Bits aus der Schraube
- ▶ Sicheres Verschrauben auf empfindlichen Oberflächen
- ▶ Sauberes Verschraubungsergebnis und weniger Verschleiß
- ▶ Kürzere Verschraubungszeiten
- ▶ Leicht erkennbar durch weißen Farbring
- ▶ Ergonomischeres Arbeiten durch Reduzierung des Anpressdruckes
- ▶ Zusätzliche Torsionszone leitet Kraftspitzen in den Bit ab – reduziert Schäden am Bit

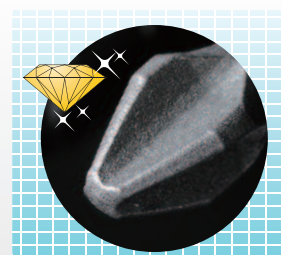

- ▶ Diamond coated bit tip minimize the "Cam-out-effect"
- ▶ Safer screw driving on sensitive surfaces
- ▶ Less fatiguing work due to the reducing of contact pressure
- ▶ High class work result
- ▶ Less wear at the tool and screw
- ▶ Quicker fastening time
- ▶ Torsion twist zone reduces bit breakage
- ▶ Easily recognizable with their white color ring

*Nur solange Vorrat reicht / *Only stock out selling quantities

1/4" TORSION BIT-Schraubendreher Einsätze

1/4" TORSION Bits



Art.-Gruppe 130
Article Group 130

1/4" TORSION BIT-Schraubendreher-Einsätze für Kreuzschlitz-Schrauben Phillips, mit ACR II – Profil, 3er Pack
Phillips TORSION Bits, ACR II - Profile,
3 pcs Box



Art.-Nr./Art.-No.	Größe/Size	Länge/Length	€
1760001-03	PH 1	25 mm	
1760002-03	PH 2	25 mm	
1760003-03	PH 3	25 mm	
1761001-03	PH 1	50 mm	
1761002-03	PH 2	50 mm	
1761003-03	PH 3	50 mm	

1/4" TORSION BIT-Schraubendreher-Einsätze für Schlitz-Schrauben, 3er Pack
Slotted TORSION Bits, 3 pcs Box



Art.-Nr./Art.-No.	Größe/Size	Länge/Length	€
1760202-03	4,0 mm	25 mm	
1760203-03	4,5 mm	25 mm	
1760205-03	5,5 mm	25 mm	
1761202-03	4,0 mm	50 mm	
1761203-03	4,5 mm	50 mm	
1761205-03	5,5 mm	50 mm	

1/4" TORSION BIT-Schraubendreher-Einsätze für Innen-TX-Schrauben, 3er Box
TX TORSION Bits, 3 pcs Box



Art.-Nr./Art.-No.	Größe/Size	Länge/Length	€
1760310-03	T10	25 mm	
1760315-03	T15	25 mm	
1760320-03	T20	25 mm	
1760325-03	T25	25 mm	
1760330-03	T30	25 mm	
1760340-03	T40	25 mm	
1761310-03	T10	50 mm	
1761315-03	T15	50 mm	
1761320-03	T20	50 mm	
1761325-03	T25	50 mm	
1761330-03	T30	50 mm	
1761340-03	T40	50 mm	

1/4" TORSION BIT-Schraubendreher-Einsätze für Kreuzschlitz-schrauben Pozidriv, mit ACR II – Profil, 3er Pack
Pozidriv TORSION Bits, ACR II - Profile,
3 pcs Box



Art.-Nr./Art.-No.	Größe/Size	Länge/Length	€
1760101-03	PZ 1	25 mm	
1760102-03	PZ 2	25 mm	
1760103-03	PZ 3	25 mm	
1761101-03	PZ 1	50 mm	
1761102-03	PZ 2	50 mm	
1761103-03	PZ 3	50 mm	

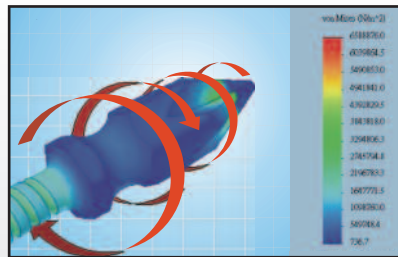

PROJAHN TORSION-Bit

Kräfte werden in den Bit abgeleitet /
Forces will disperse at torsion zone

- ▶ Für höchste Belastung ausgelegt
- ▶ Ideal für Schlagschrauber geeignet
- ▶ Spezielle Torsionszone leitet die Belastung der Bohrspitze in den Bit ab
- ▶ Wesentlich längere Standzeit und geringere Bruchgefahr
- ▶ Reduzierung des Herausrutschens des Bits durch zusätzliche ACR-Profil

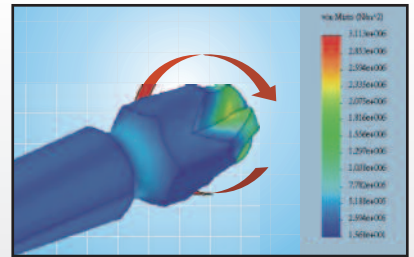

Standard-Bit

Kräfte werden an der Spitze zentriert /
Forces will accumulated at the tip of bit

- ▶ Produced of high-performance Steel – Designed for maximum forces
- ▶ Especially suitable for use with impact drivers
- ▶ Special designed torsion zone absorbs forces into the bit
- ▶ Longer durability and less breakage
- ▶ Additional with Cam-out-rips

5/16" BIT- Schraubendreher Einsätze

5/16" Bits



Art.-Gruppe 130
Article Group 130

5/16" Schraubendreher-Einsätze für Kreuzschlitz-Schrauben Phillips
Phillips Bits



Art.-Nr./Art.-No.	Größe/Size	Länge/Length	€
303001	PH 1	30 mm	
303002	PH 2	30 mm	
303003	PH 3	30 mm	
303004	PH 4	30 mm	
313001	PH 1	70 mm	
313002	PH 2	70 mm	
313003	PH 3	70 mm	

5/16" Schraubendreher-Einsätze für Schlitz-Schrauben
Slotted Bits



Art.-Nr./Art.-No.	Größe/Size	Länge/Length	€
302055	5,5 x 0,8 mm	30 mm	
302065	6,5 x 1,0 mm	30 mm	
302080	8,0 x 1,2 mm	30 mm	
302100	10,0 x 1,6 mm	30 mm	
302120	12,0 x 2,0 mm	30 mm	

5/16" Schraubendreher-Einsätze für Innen-TX-Schrauben
TX Bits



Art.-Nr./Art.-No.	Größe/Size	Länge/Length	€
305010	T10	30 mm	
305015	T15	30 mm	
305020	T20	30 mm	
305025	T25	30 mm	
305027	T27	30 mm	
305030	T30	30 mm	
305040	T40	30 mm	
305045	T45	30 mm	
305050	T50	30 mm	
305055	T55	30 mm	
305060	T60	30 mm	
305070	T70	30 mm	

5/16" Schraubendreher-Einsätze für Innen-TX-Schrauben mit stirnseitiger Bohrung
Taper TX Bits



Art.-Nr./Art.-No.	Größe/Size	Länge/Length	€
305310	T10	30 mm	
305315	T15	30 mm	
305320	T20	30 mm	
305325	T25	30 mm	
305327	T27	30 mm	
305330	T30	30 mm	
305340	T40	30 mm	
305345	T45	30 mm	
305350	T50	30 mm	
305355	T55	30 mm	
305360	T60	30 mm	
305370	T70	30 mm	

5/16" Schraubendreher-Einsätze für Innensechskant-Schrauben
Hex Bits



Art.-Nr./Art.-No.	Größe/Size	Länge/Length	€
306004	4 mm	30 mm	
306005K	5 mm	30 mm	
306006	6 mm	30 mm	
306007	7 mm	30 mm	
306008	8 mm	30 mm	
306010	10 mm	30 mm	
306012	12 mm	30 mm	
306014	14 mm	30 mm	
316004	4 mm	70 mm	
316005	5 mm	70 mm	
316006	6 mm	70 mm	
316008	8 mm	70 mm	

5/16" Schraubendreher-Einsätze für Kreuzschlitz-Schrauben Pozidriv
Pozidriv Bits



Art.-Nr./Art.-No.	Größe/Size	Länge/Length	€
304001	PZ 1	30 mm	
304002	PZ 2	30 mm	
304003	PZ 3	30 mm	
304004	PZ 4	30 mm	
314001	PZ 1	70 mm	
314002	PZ 2	70 mm	

10 mm BIT- Schraubendreher Einsätze

10 mm Bits

**Art.-Gruppe 130**
Article Group 130**10 mm Schraubendreher-Einsätze
für Vielzahn-Schrauben**

10 mm Spline Impact Bits



Art.-Nr./Art.-No.	Größe/Size	Länge/Length	€
348605	M5	30 mm	
348606	M6	30 mm	
348608	M8	30 mm	
348610	M10	30 mm	
348612	M12	30 mm	
348614	M14	30 mm	
348705	M5	75 mm	
348706	M6	75 mm	
348708	M8	75 mm	
348710	M10	75 mm	
348712	M12	75 mm	
348714	M14	75 mm	

**10 mm Schraubendreher-Einsätze
für Innensechskant-Schrauben**

10 mm Hex Bits



Art.-Nr./Art.-No.	Größe/Size	Länge/Length	€
306040	4 mm	30 mm	
306050	5 mm	30 mm	
306060	6 mm	30 mm	
306080	8 mm	30 mm	
306100	10 mm	30 mm	
306120	12 mm	30 mm	

**10 mm Schraubendreher-Einsätze
für Innen-TX-Schrauben**

10 mm TX Impact Bits



Art.-Nr./Art.-No.	Größe/Size	Länge/Length	€
305620	T20	30 mm	
305625	T25	30 mm	
305627	T27	30 mm	
305630	T30	30 mm	
305640	T40	30 mm	
305645	T45	30 mm	
305650	T50	30 mm	
305655	T55	30 mm	
305660	T60	30 mm	
305670	T70	30 mm	
315620	T20	75 mm	
315625	T25	75 mm	
315627	T27	75 mm	
315630	T30	75 mm	
315640	T40	75 mm	
315645	T45	75 mm	
315650	T50	75 mm	
315655	T55	75 mm	
315660	T60	75 mm	
315670	T70	75 mm	

**10 mm Schraubendreher-Einsätze
für Innen-TX-Schrauben
mit stirnseitiger Bohrung**

10 mm Tamper TX Impact Bits



Art.-Nr./Art.-No.	Größe/Size	Länge/Length	€
305720	T20	30 mm	
305725	T25	30 mm	
305727	T27	30 mm	
305730	T30	30 mm	
305740	T40	30 mm	
305745	T45	30 mm	
305750	T50	30 mm	
305755	T55	30 mm	
305760	T60	30 mm	
305770	T70	30 mm	
315720	T20	75 mm	
315725	T25	75 mm	
315727	T27	75 mm	
315730	T30	75 mm	
315740	T40	75 mm	
315745	T45	75 mm	
315750	T50	75 mm	
315755	T55	75 mm	
315760	T60	75 mm	
315770	T70	75 mm	

4295**10 mm Bit Ratsche umschaltbar**

10 mm Bit Ratchet reversible



Art.-Nr./Art.-No.	Größe/Size	Länge/Length
4295	10 mm	138 mm

1/4" Spezial- und Sonder-BIT- Schraubendreher Einsätze

1/4" Special And Security Bits



Art.-Gruppe 130
Article Group 130

1/4" Schraubendreher-Einsätze Robertson für SpanoElecPlus-Schrauben

Robertson Bits



Art.-Nr./Art.-No.	Größe/Size	Länge/Length	€
2651	R1/2,5 mm	25 mm	
2652	R2/3,0 mm	25 mm	
2653	R3/3,5 mm	25 mm	
2656	R1/2,5 mm	50 mm	
2657	R2/3,0 mm	50 mm	
2658	R3/3,5 mm	50 mm	

1/4" Schraubendreher-Einsätze für Spanner-Schrauben

Spanner Bits

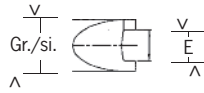

Art.-Nr./Art.-No.	Größe/Size	Länge/Le.	E	€
2665	4 mm	25 mm	1,52	
2667	6 mm	25 mm	2,41	
2668	8 mm	25 mm	3,00	
2669	10 mm	25 mm	3,60	
2691	12 mm	25 mm	3,81	
2692	14 mm	25 mm	5,00	

1/4" Schraubendreher-Einsätze für Clutch Schrauben

Clutch Bits



Art.-Nr./Art.-No.	Größe/Size	Länge/Length	€
3181	3/32	25 mm	
3182	1/8	25 mm	
3183	5/32	25 mm	
3184	3/16	25 mm	
3185	1/4	25 mm	

1/4" Schraubendreher-Einsätze für Torq-Schrauben

Torq Bits



Art.-Nr./Art.-No.	Größe/Size	Länge/Length	€
2661	6 mm	25 mm	
2662	8 mm	25 mm	
2663	10 mm	25 mm	

1/4" Eindreh-Bit für Haken

Hook Driver



Art.-Nr./Art.-No.	Größe/Size	€
2690	1/4"	

1/4" Schraubendreher-Einsätze für Vielzahn Schrauben

Spline Bits



Art.-Nr./Art.-No.	Größe/Size	Länge/Length	€
3161	M4	25 mm	
3162	M5	25 mm	
3163	M6	25 mm	
3164	M8	25 mm	
3165	M10	25 mm	

1/4" Schraubendreher-Einsätze für Tri-Wing-Schrauben

Tri-Wing Bits



Art.-Nr./Art.-No.	Größe/Size	Länge/Length	€
2671	Nr. 1	25 mm	
2672	Nr. 2	25 mm	
2673	Nr. 3	25 mm	
2674	Nr. 4	25 mm	

1/4" Schraubendreher-Einsätze für Assy-Schrauben/SIT-Bits

SIT® Bits

Spezial-Profil



Art.-Nr./Art.-No.	Größe/Size	Länge/Length	€
2890	PW10	25 mm	
2891	PW15	25 mm	
2892	PW20	25 mm	
2893	PW25	25 mm	
2894	PW30	25 mm	
2895	PW40	25 mm	

SIT® und Assy® sind eingetragene Warenzeichen der Adolf Würth GmbH / SIT® and Assy® are registered trade marks of company Adolf Würth GmbH

1/4" Schraubendreher-Einsätze für Keilzahn Schrauben

Ribe Bits



Art.-Nr./Art.-No.	Größe/Size	Länge/Length	€
3171	M4	25 mm	
3172	M5	25 mm	
3173	M6	25 mm	
3174	M7	25 mm	
3175	M8	25 mm	

1/4" BIT-Stecknüsse, -Adapter, -Halter

1/4" Bits



Art.-Gruppe 130
Article Group 130

PROFESSIONAL PLUS STANDARD

Stecknuss Bit mit Dauermagnet

Magnetic Nut Setter

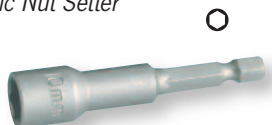

Art.-Nr./Art.-No.	Größe/Size	Länge/Length	€
3783-06	6 mm	45 mm	
3783-07	7 mm	45 mm	
3783-08	8 mm	45 mm	
3783-10	10 mm	45 mm	
3783-11	11 mm	45 mm	
3783-12	12 mm	45 mm	
3783-13	13 mm	45 mm	

3784-55	5,5 mm	65 mm	
3784-06	6 mm	65 mm	
3784-07	7 mm	65 mm	
3784-08	8 mm	65 mm	
3784-10	10 mm	65 mm	
3784-11	11 mm	65 mm	
3784-12	12 mm	65 mm	
3784-13	13 mm	65 mm	
3784-15	15 mm	65 mm	
3784-16	16 mm	65 mm	
3784-17	17 mm	65 mm	
3784-1/4	1/4"	65 mm	
3784-5/16	5/16"	65 mm	
3784-3/8	3/8"	65 mm	

Sortimente auf Seite / Sets on Page
H 192

PROFESSIONAL PLUS STANDARD

Stecknuss Bit für Edelstahlschrauben mit Haltefeder

Nut Setter With Spring For Stainless Screws



Art.-Nr./Art.-No.	Größe/Size	Länge/Length	€
3785-08	8 mm	45 mm	
3785-10	10 mm	45 mm	
3785-1/4	1/4"	45 mm	
3785-5/16	5/16"	45 mm	
3785-3/8	3/8"	45 mm	

PROFESSIONAL PLUS STANDARD

Eindrehwerkzeuge für Stockschrauben mit Innengewinde

Screw Tight Tool for Setting Screws



Art.-Nr./Art.-No.	Größe/Size	€
3784-M6	M 6	
3784-M8	M 8	
3784-M10	M10	
3784-M12	M12	

PROFESSIONAL PLUS STANDARD

1/4" Stecknuss Bit Adapter für Nüsse

Bit Adapter For Sockets



Art.-Nr./Art.-No.	Größe/Size	Länge/Length	€
2770	1/4" x 1/4"	25 mm	
2850	1/4" x 1/4"	50 mm	
2862	1/4" x 1/4"	100 mm	
2860	1/4" x 3/8"	50 mm	
2864	1/4" x 3/8"	100 mm	
2870	1/4" x 1/2"	50 mm	

PROFESSIONAL PLUS STANDARD

1/4" Stecknuss Bit Adapter Satz, 3-tlg. 50 mm für Stecknüsse 1/4", 3/8", 1/2"

Bit Adapter Set, 3 pieces 50 mm For Sockets 1/4", 3/8", 1/2"



3
tlg./pcs.

Art.-Nr./Art.-No.	Größe/Size	Länge/Length	€
2880	1/4" x 1/4"	50 mm	
	1/4" x 3/8"	50 mm	
	1/4" x 1/2"	50 mm	

PROFESSIONAL PLUS STANDARD

Bit Halter

Bit Holder



Art.-Nr./Art.-No.	Größe/Size
2769	1/4" Bit-Halter mit SDS-Aufnahme bit holder with quick release – SDS-shank

PROFESSIONAL PLUS STANDARD

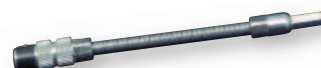

Art.-Nr./Art.-No.	Länge/Length
107140	Verlängerung flexibel 135 mm flexible extension bar 135 mm

PROFESSIONAL PLUS STANDARD

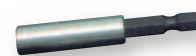

Art.-Nr./Art.-No.	Länge/Length
2750	1/4" Universal 60 mm magnetic bit holder 60 mm

PROFESSIONAL PLUS STANDARD



Art.-Nr./Art.-No.	Länge/Length
2764	1/4" Universal 142 mm magnetic bit holder 142 mm

PROFESSIONAL PLUS STANDARD

Bit Adapter

Bit Adapter



Art.-Nr./Art.-No.	Größe/Size	€
2760	1/4" Adapter für 1/4" Bits	
2761	3/8" Adapter für 1/4" Bits	
311516	1/2" Adapter für 5/16" Bits	
381214	1/2" Schlag-Adapter für 1/4" Bits	

1/4" BIT-Halte- und Antriebswerkzeuge

1/4" Bits



Art.-Gruppen 120/130/132/140
Article Groups 120/130/132/140

PROFESSIONAL PLUS STANDARD

Bit Halter
Bit Holder



Art.-Nr./Art.No.	Größe/Size	Länge/Length
2765	1/4" mit Schnellspannfutter	60 mm
Bit Holder With Quick Release 60 mm		

PROFESSIONAL PLUS STANDARD



Art.-Nr./Art.No.	Größe/Size	Länge/Length
2766	1/4" mit Schnellspannfutter	152 mm
Bit Holder With Quick Release 152 mm		

PROFESSIONAL PLUS STANDARD



Art.-Nr./Art.No.	Größe/Size
2767	1/4" mit Schnellspannfutter
Bit Holder With Quick Release 305 mm	

PROFESSIONAL PLUS STANDARD



Art.-Nr./Art.No.	Größe/Size
3750	1/4" mit „Ring-Magnet“ und Tiefeneinstellung
Magnetic Bit Holder with Screw-Cap and Depth Adjustment	

PROFESSIONAL PLUS STANDARD

1/4" Mini Bit Ratsche umschaltbar
1/4" Mini Bit Ratchet



Art.-Nr./Art.No.	Größe/Size	Länge/Length
2700	1/4"	98 mm

PROFESSIONAL PLUS STANDARD

Magnetische Bit Schraubendreher für Handbetrieb 1/4"
Bit Screwdriver



Art.-Nr./Art.No.	Größe/Size
2128	1/4" Universal, schwarzer Griff
Magnetic Bit Screwdriver, Black Handle	

PROFESSIONAL PLUS STANDARD



Art.-Nr./Art.No.	Größe/Size
4190-01	1/4" Universal
Magnetic Bit Screwdriver	

PROFESSIONAL PLUS STANDARD



Art.-Nr./Art.No.	Größe/Size
4690-02	1/4" mit Schnellspannfutter
Quick Release Bit Screwdriver	

PROFESSIONAL PLUS STANDARD



Art.-Nr./Art.No.	Größe/Size
4190-03	1/4" kurz mit Schnellspannfutter
Quick Release Bit Screwdriver, Short Version	

PROFESSIONAL PLUS STANDARD



Art.-Nr./Art.No.	Größe/Size
4691-14	1/4" Bit T-Griff
T-Handle Bit Screwdriver	

PROFESSIONAL PLUS STANDARD

1/4" XS Mini-Bit-Knarre, umschaltbar
1/4" Mini Ratchet Handle, Reversible



Art.-Nr./Art.No.	Größe/Size	Länge/Length
4288	1/4"	86 mm

PROFESSIONAL PLUS STANDARD

1/4" Mini Bit Ratsche umschaltbar
1/4" Mini Bit Ratchet reversible



Art.-Nr./Art.No.	Größe/Size	Länge/Length
4294	1/4"	103 mm

PROFESSIONAL PLUS STANDARD

Dual Umschaltknarre für Bits + Nüsse
Dual Ratchet Handle For Bits + Sockets



Art.-Nr./Art.No.	Größe/Size	Länge/Length
4290	1/4"	105 mm

PROFESSIONAL PLUS STANDARD

10 mm Bit Ratsche umschaltbar
10 mm Bit Ratchet reversible



Art.-Nr./Art.No.	Größe/Size	Länge/Length
4295*	10 mm	138 mm

*Nur solange Vorrat reicht / only stock out selling quantities

1/4" BIT-Sätze

1/4" Bit Sets

1/4"

Art.-Gruppe 131
Article Group 131

394074 PROFESSIONAL PLUS STANDARD

NEU/NEW

1/4" **1/4" KOMBI BIT Box**
Bit Set

31
tlg./pcs.



- | | | | |
|---|---|--|---|
| 3 | ⊖ | Schlitz/Slotted | 4 - 5.5 - 6.5 mm |
| 5 | ⊕ | Phillips/PH | PH 1 - PH 1 - PH 2 - PH 2 - PH 3 |
| 5 | ⊕ | Pozidriv/PZ | PZ 1 - PZ 1 - PZ 2 - PZ 2 - PZ 3 |
| 9 | ⊗ | TORX®/TX | T8 - 9 - 10 - 15 - 20 - 25 - 27 - 30 - 40 |
| 8 | ⊙ | Inbus/Hex | 2 - 2,5 - 3 - 4 - 5 - 6 - 7 - 8 mm |
| 1 | | Magnethalter mit Schnellspannfutter, 60 mm | |

Art.-Nr./Art.No.	G/S	tlg./pcs.	B	L	H
394074*	1/4"	31	105	65	41
39407412*	1/4"	12 x 31	323	277	72

Display mit 12 Boxen 394074

*Lieferbar ab August 2015

394075 PROFESSIONAL PLUS STANDARD

NEU/NEW

1/4" **1/4" KOMBI BIT Box**
Bit Set

31
tlg./pcs.



- | | | | |
|---|---|--|------------------------------------|
| 3 | ⊖ | Schlitz/Slotted | 4 - 5.5 - 6.5 mm |
| 5 | ⊕ | Phillips/PH | PH 1 - PH 1 - PH 2 - PH 2 - PH 3 |
| 5 | ⊕ | Pozidriv/PZ | PZ 1 - PZ 1 - PZ 2 - PZ 2 - PZ 3 |
| 9 | ⊗ | TORX® mit Bohrung/TX | T8 - 9 - 10 - 15 - 20 - |
| | | Tamper TX | 25 - 27 - 30 |
| 8 | ⊙ | Inbus/Hex | 2 - 2,5 - 3 - 4 - 5 - 6 - 7 - 8 mm |
| 1 | | Magnethalter mit Schnellspannfutter, 60 mm | |

Art.-Nr./Art.No.	G/S	tlg./pcs.	B	L	H
394075*	1/4"	31	105	65	41
39407512*	1/4"	12 x 31	323	277	72

Display mit 12 Boxen 394075

*Lieferbar ab August 2015

PROFESSIONAL PLUS STANDARD

4085

1/4"

22
tlg./pcs.



1/4" Allround-Bit Box, 22-teilig

Allround-Bit Set, 22 pieces

- | | | | |
|---|---|-----------------|---------------------------------------|
| 3 | ⊖ | Schlitz/Slotted | 4,5 - 5,5 - 6,5 mm |
| 2 | ⊕ | Phillips/PH | PH 1 - PH 2 |
| 3 | ⊕ | Pozidriv/PZ | PZ 1 - PZ 2 - PZ 3 |
| 8 | ⊗ | TORX®/TX | T8 - 10 - 15 - 20 - 25 - 27 - 30 - 40 |
| 4 | ⊙ | Stecknuss Bit | 7 - 8 - 10 - 11 mm |
| 1 | | Magnethalter | |
| 1 | | Bit Adapter | 1/4" x 1/4" |

Art.-Nr./Art.No.	G./S.	tlg./pcs.	B	L	H
4085	1/4"	22	115	95	32

Bits aus S2-Stahl

Größe/Size: 1/4" · tlg./pcs.: 22 · BxLxH/WxLxH: 115x95x32 mm

Gewicht/Weight: 280 g

1/4" BIT-Sätze

1/4" Bit Sets

1/4"

Art.-Gruppe 131
Article Group 131

394070

PROFESSIONAL PLUS STANDARD

NEU/NEW

1/4"

1/4" Stubby-Bit-Box, 20-teilig
1/4" Stubby Bit Set, 20 pieces

20
tlg./pcs.

- 2 Schlitz/Slotted 4 - 5,5 mm
- 3 Phillips PH1 - 2 - 3
- 3 Pozidriv PZ1 - 2 - 3
- 5 TORX® TX10 - 15 - 20 - 25 - 30
- 4 Inbus/Hex 3 - 4 - 5 - 6 mm
- 1 Adapter 1/4" x 1/4"
- 1 Stubby-Ratschenschraubendr.
- 1 Magnethalter mit Schnellspannfutter, 60 mm
Magnetic Bit Holder with quick release



394071

PROFESSIONAL PLUS STANDARD

NEU/NEW

1/4"

1/4" Universal Stubby-Bit-Box, 23-teilig
1/4" Universal Stubby Bit Set, 23 pieces

23
tlg./pcs.

- 5 Stecknüsse/Sockets 5 - 6 - 7 - 8 - 10 mm
- 2 Schlitz/Slotted 4,5 - 5,5 mm
- 3 Phillips PH1 - 2 - 3
- 3 Pozidriv PZ1 - 2 - 3
- 4 TORX® TX10 - 15 - 20 - 25
- 4 Inbus/Hex 3 - 4 - 5 - 6 mm
- 1 Adapter 1/4" x 1/4"
- 1 Stubby-Ratschenschraubendreher



Art.-Nr./Art.-No.	G./S.	tlg./pcs	B	L	H
394070	1/4"	20	115 mm	80 mm	45 mm

39407010	1/4"	10 x 20	190 mm	245 mm	115 mm
Display mit 10 Boxen 394070					

Art.-Nr./Art.-No.	G./S.	tlg./pcs	B	L	H
394071	1/4"	23	115 mm	80 mm	45 mm

39407110	1/4"	10 x 23	190 mm	245 mm	115 mm
Display mit 10 Boxen 394071					



190 x 245 x 115 mm
Höhe geöffnet/height open: 315 mm
Art. 39407010
Display mit /with 10x 394070



190 x 245 x 115 mm
Höhe geöffnet/height open: 315 mm
Art. 39407110
Display mit /with 10x 394071

PROFESSIONAL PLUS STANDARD

4193

1/4"

8
tlg./pcs.



1/4" Stubby-Ratschenschraubendreher
1/4" Stubby Ratchet Screw Driver

NEU/NEW

235 x 185 x 120 mm
Höhe geöffnet/height open: 265 mm
Art. 419312

Display mit /with 12x 4193

Art.-Nr./Art.-No.	G./S.	tlg./pcs	B	L	H
4193	1/4"	8	95 mm	38 mm	38 mm

419312	1/4"	12 x 8	235 mm	185 mm	120 mm
Display mit 12 x 4193					

- 1 Schlitz/Slotted 5,5 mm
- 2 Phillips/PH PH 1 - 2
- 2 Pozidriv/PZ PZ 1 - 2
- 2 TORX®/TX T20 - 25
- 1 Stubby-Ratschenschraubendreher

1/4" + 5/16" BIT-Sätze

1/4" + 5/16" Bit Sets

1/4" 5/16"

Art.-Gruppe 131
Article Group 131

4092

PROFESSIONAL PLUS STANDARD

1/4"

1/4" + 5/16" Kombi-Bit-Box,
inkl. GearTech Doppelringschlüssel
1/4" + 5/16" Combi Bit Set,
incl. GearTech Bit Double Ring Wrench

32
tlg./pcs.

5/16"



3914516

PROFESSIONAL PLUS STANDARD

1/4" + 5/16" GearTech Doppelringschlüssel
1/4" + 5/16" GearTech Bit Double Ring Wrench

GearTech



Umschaltbar, ergonomisch gebogen/reversible, ergonomically curved

			1/4"
3	☉	Schlitz/Slotted	4 - 5,5 - 6,5 mm
2	⊕	Phillips/PH	PH 1 - PH 2
2	⊕	Pozidriv/PZ	PZ 1 - PZ 2
6	⊗	TORX®/TX	TX8 - 10 - 15 - 20 - 25 - 27
4	⊙	Inbus/Hex	3 - 4 - 5 - 6 mm

			5/16"
2	☉	Schlitz/Slotted	8 - 10 mm
2	⊕	Phillips/PH	PH 3 - PH 4
2	⊕	Pozidriv/PZ	PZ 3 - PZ 4
6	⊗	TORX®/TX	TX30 - 40 - 45 - 50 - 55 - 60
2	⊙	Inbus/Hex	7 - 8 mm

1 GearTech Doppelringschlüssel 1/4" + 5/16"

Art.-Nr./Art.-No.	G./S.	tlg./pcs.	B	L	H
4092	1/4" + 5/16"	32	135	85	33
3914516	1/4" + 5/16"	GearTech Doppelringschlüssel (125 mm)			

1/4" BIT-Sätze

1/4" Bit Sets



Art.-Gruppe 132
Article Group 132

4091 PROFESSIONAL PLUS STANDARD



1/4" Color-Bit-Box, 15-teilig
1/4" Color Bit Set, 15 pieces

15
tlg./pcs.



- | | | | |
|---|--|----------------------------------|-------------------------|
| 2 | | Schlitz/Slotted (rot/red) | 4 - 6 mm |
| 2 | | Phillips/PH (dunkelrot/dark red) | PH 1 - PH 2 |
| 2 | | Pozidriv/PZ (blau/blue) | PZ 1 - PZ 2 |
| 5 | | TORX®/TX (gelb/yellow) | T10 - 15 - 20 - 25 - 30 |
| 3 | | Inbus/Hex (orange) | 3 - 4 - 5 mm |
| 1 | | Bit Magnethalter | 60 mm |

Art.-Nr./Art.-No.	G./S.	tlg./pcs	B	L	H
4091	1/4"	15	50	95	30

409124	1/4"	24 x 15	315	320	100
Display mit 24 Boxen 4091					

Praktische Kunststoff-Kassette mit automatisch aufklappbarem Klarsichtdeckel. Passt bequem in jede Werkzeugtasche. Farblich markierte Bits erleichtern das Suchen der richtigen Größe.

Convenient plastic cases with automatically opening transparent lid. Best for every kind of tool bag. Very easy to find the right size, because of colored bits.

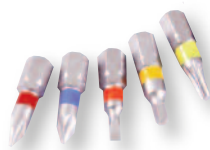

315 x 320 x 100 mm
Höhe geöffnet/height open: 320 mm
Art. 409124
Display mit /with 24x 4091

394089 PROFESSIONAL PLUS STANDARD

NEU/NEW



1/4" Color-Bit-Box, 32-teilig
1/4" Color Bit Set, 32 pieces

32
tlg./pcs.



- | | | | |
|---|--|--|----------------------------|
| 2 | | Schlitz/Slotted (rot/red) | 4 - 5 mm |
| 4 | | Phillips/PH (dunkelrot/dark red) | PH 1 - 2 - 2 - 3 |
| 4 | | Pozidriv/PZ (blau/blue) | PZ 1 - 2 - 2 - 3 |
| 7 | | TORX®/TX (gelb/yellow) | TX10-15-20-25-27-30-40 |
| 7 | | TORX® mit Bo./Tampor TX (violett) | TX10-15-20-25-27-30-40 |
| 6 | | Inbus/Hex (orange) | 2 - 2,5 - 3 - 4 - 5 - 6 mm |
| 1 | | Stecknuss Bit Adapter | 1/4" x 1/4", 25 mm |
| 1 | | Magnethalter mit Schnellspannfutter, 60 mm | |

Art.-Nr./Art.-No.	G./S.	tlg./pcs	B	L	H
394089	1/4"	32	95	65	40

39408912	1/4"	12 x 32	356	270	72
Display mit 12 Boxen 394089					

Praktische Kunststoff-Kassette mit Klarsichtdeckel. Passt bequem in jede Werkzeugtasche. Farblich markierte Bits erleichtern das Suchen der richtigen Größe.

Convenient plastic cases with transparent top cover. Best for every kind of tool bag. Very easy to find the right size, because of colored bits.



356 x 270 x 72 mm
Höhe geöffnet/height open: 340 mm
Art. 39408912
Display mit /with 12x 394089

1/4" BIT-Sätze

1/4" Bit Sets

1/4"

Art.-Gruppe 132
Article Group 132

4095 PROFESSIONAL PLUS STANDARD

1/4"

1/4" Color-Bit-Box mit Mini-Bit-Knarre
Color Bit Set With Mini-Ratchet-Handle

33
tlg./pcs.



4090 PROFESSIONAL PLUS STANDARD

1/4"

1/4" Color-Bit-Box XL
Color Bit Set „Color BIT Box XL“

71
tlg./pcs.



- 4 Schlitz/Slotted (rot/red) 3 - 4 - 5 - 6 mm
- 4 Phillips/PH (dunkelrot/dark red) PH 1 - 2 - 2 - 3
- 4 Pozidriv/PZ (blau/blue) PZ 1 - 2 - 2 - 3
- 4 Inbus (orange) 3 - 4 - 5 - 6 mm
- 7 TORX®/TX (gelb/yellow) T10 - 15 - 20 - 25 - 27 - 30 - 40
- 7 TORX® mit Bo./Tampfer TX (violett) T10 - 15 - 20 - 25 - 27 - 30 - 40
- 1 Stecknuss Bit Adapter 25 mm
- 1 Bit Magnethalter 60 mm
- 1 XS Mini-Bit-Knarre (Art-Nr. 4288)

25 mm

- 6 Schlitz/Slotted (rot/red) 3x 4 mm / 3x 6 mm
- 12 Phillips/PH (dunkelrot/dark red) 3x PH 1 / 6x PH 2 / 3x PH 3
- 12 Pozidriv/PZ (blau/blue) 3x PZ 1 / 6x PZ 2 / 3x PZ 3
- 9 Inbus (orange) 3x 4 mm / 3x 5 mm / 3x 6 mm
- 21 TORX®/TX (gelb/yellow) 3x TX10 / 15 / 20 / 25 / 27 / 30 / 40

75 mm

- 2 Schlitz/Slotted (rot/red) 1x 4 mm / 1x 6 mm
- 3 Phillips/PH (dunkelrot/dark red) 1x PH 1 / 1x PH 2 / 1x PH 3
- 2 Pozidriv/PZ (blau/blue) 1x PZ 1 / 1x PZ 2
- 2 TORX®/TX (gelb/yellow) 1x TX20 / TX25

- 1 Bit Magnethalter
- 1 Bit Halter mit Schnellspannfutter

Art.-Nr./Art.-No.	G./S.	tlg./pcs	B	L	H
4095	1/4"	33	125	70	35

409512	1/4"	12 x 33	333	313	84
Display mit /with 12 Boxen 4095					

Art.-Nr./Art.-No.	G./S.	tlg./pcs	B	L	H
4090	1/4"	71	155	120	35

409006	1/4"	6 x 71	185	375	120
Display mit /with 6 Boxen 4090					

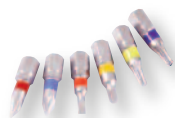

125 x 333 x 84 mm
Höhe geöffnet/height open: 307 mm
Art. 409512
Display mit /with 12x 4095

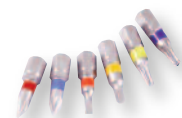

185 x 375 x 120 mm
Höhe geöffnet/height open: 270 mm
Art. 409006
Display mit /with 6x 4090

1/4" BIT-Sätze

1/4" Bit Sets

1/4"

Art.-Gruppe 132
Article Group 132

4094 PROFESSIONAL PLUS STANDARD

1/4" Color-Bit-Box 25 + 75 mm
Color Bit Set 25 + 75 mm

1/4"

56
tlg./pcs.



25 mm

- 6 Schlitz/Slotted (rot/red) 2x 4 - 5 - 6 mm
- 9 Phillips (dunkelrot/dark red) 3x PH 1 - 2 - 3
- 9 Pozidriv (blau/blue) 3x PZ 1 - 2 - 3
- 14 TORX® (gelb/yellow) 2x TX10 - 15 - 20 - 25 - 27 - 30 - 40
- 7 TORX® mit Loch (violett) 1x TX10 - 15 - 20 - 25 - 27 - 30 - 40
- 3 Inbus/Hex. (orange) 1x 3 - 4 - 5 mm

75 mm

- 1 Schlitz/Slotted (rot/red) 1x 6 mm
- 3 Phillips (dunkelrot/dark red) 1x PH 1 - 2 - 3
- 3 Pozidriv (blau/blue) 1x PZ 1 - 2 - 3
- 1 Bit Halter mit Schnellspannfutter/
Magnetic bit holder with quick release

4097 PROFESSIONAL PLUS STANDARD

Verbesserte Ausführung /
Improved Quality

1/4" Universal Color-Bit-Box
mit Ratschenschraubendreher
Universal Color Bit Set
with Ratchet Screwdriver

1/4"

60
tlg./pcs.



25 mm

- 2 Schlitz/Slotted (rot/red) 4 - 5 mm
- 4 Phillips (dunkelrot/dark red) PH 1 - 2 - 2 - 3
- 4 Pozidriv (blau/blue) PZ 1 - 2 - 2 - 3
- 6 TORX® (gelb/yellow) TX10 - 15 - 20 - 25 - 30 - 40
- 6 TORX® mit Loch (violett) TX10 - 15 - 20 - 25 - 30 - 40
- 6 Inbus (orange) 2 - 2,5 - 3 - 4 - 5 - 6 mm
- 10 magn. Stecknuss-Bits (orange) 5 - 5,5 - 6 - 7 - 8 - 9 - 10 - 11 - 12 - 13 mm
- 1 Stecknuss-Bit (blau/blue) 4 mm

75 mm

- 2 Phillips (dunkelrot/dark red) PH 1 - 2
- 2 Pozidriv (blau/blue) PZ 1 - 2
- 3 TORX® (gelb/yellow) TX15 - 20 - 25
- 2 Inbus (orange) 4 - 5 mm
- 1 Bit-Halter mit Schnellspannfutter/
Magnetic bit holder with quick release
- 1 Ratschenschraubendreher inkl. 10 Color-Bits/
Ratchet Screwdriver incl. 10 Color-Bits (Art-Nr. 4192)
- 2 Schlitz/Slotted (rot/red) 4 - 6 mm
- 2 Phillips (dunkelrot/dark red) PH 1 - 2
- 2 Pozidriv (blau/blue) PZ 1 - 2
- 2 TORX® (gelb/yellow) TX20 - 25
- 2 Inbus/Hex. (orange) 3 - 5 mm

Art.-Nr./Art.-No.	G./S.	tlg./pcs	B	L	H
4094	1/4"	56	127	95	34

Art.-Nr./Art.-No.	G./S.	tlg./pcs	B	L	H
4097	1/4"	60	268	187	60

4192	1/4"	10			
1/4" Ratschenschraubendreher inkl. 10 Color-Bits/ 1/4" Ratchet Screwdriver incl. 10 Color-Bits					
419212	1/4"	12 x 11	157	212	245
1/4" Ratschenschraubendreher-Display					

1/4" BIT-Sätze

1/4" Bit Sets



Art.-Gruppen 132/133
Article Groups 132/133

4093 PROFESSIONAL PLUS STANDARD



1/4" Color-Bit-Box 75 mm, 18-teilig
Color Bit Set 75 mm, 18 pieces



- | | | | |
|---|--|----------------------------------|-----------------------------------|
| 2 | | Schlitz/Slotted (rot/red) | 4 - 6 mm |
| 3 | | Phillips/PH (dunkelrot/dark red) | PH 1 - 2 - 3 |
| 3 | | Pozidriv/PZ (blau/blue) | PZ 1 - 2 - 3 |
| 3 | | Inbus (orange) | 3 - 4 - 5 mm |
| 7 | | TORX®/TX (gelb/yellow) | T10 - 15 - 20 - 25 - 27 - 30 - 40 |

Art.-Nr./Art.No.	G./S.	tlg./pcs	B	L	H
4093	1/4"	18	155	120	35
409306	1/4"	6 x 18	180	275	120

Display mit 6 Boxen 4093

Farbig markierte Bits erleichtern das Suchen der richtigen Größe.

Very easy to find the right size, because of colored bits.



180 x 375 x 120 mm
Höhe geöffnet/height open: 270 mm
Art. 409306
Display mit /with 6x 4093

394073 PROFESSIONAL PLUS STANDARD

NEU/NEW



1/4" Bit-Box mit Drehgriffknarre, 33-tlg.
1/4" Bit Set with Twist Handle Ratchet, 32 pcs



- ▶ **Bit-Drehknarre: Ideal für das Arbeiten an extrem unzugänglichen Stellen**
- ▶ *Bit twist ratchet: Ideal for working on extremely narrow spaces*



25 mm

- | | | | | |
|----|--|----------------------------------|--------------------------------|--|
| 1 | | Schlitz/Slotted (rot/red) | 4 mm | |
| 3 | | Phillips/PH (dunkelrot/dark red) | PH1 - 2 - 3 | |
| 3 | | Pozidriv/PZ (blau/blue) | PZ1 - 2 - 3 | |
| 3 | | TORX®/TX (gelb/yellow) | TX15 - 20 - 25 | |
| 3 | | Inbus/Hex (orange) | 3 - 4 - 5 mm | |
| 11 | | Stecknuss-Bits | 4-5-5,5-6-7-8-9-10-11-12-13 mm | |
| 2 | | Adapter | 1/4"x1/4" + 1/4"x3/8" | |

50 mm

- | | | | | |
|---|--|---|-----------|--|
| 2 | | Phillips/PH (dunkelrot/dark red) | PH1 - 2 | |
| 2 | | TORX®/TX (gelb/yellow) | TX10 - 20 | |
| 2 | | Inbus/Hex (orange) | 4 - 6 mm | |
| 1 | | 1/4" Bit-Drehgriffknarre/Twist handle ratchet | | |

Art.-Nr./Art.No.	G./S.	tlg./pcs	B	L	H
394073	1/4"	33	200	120	40

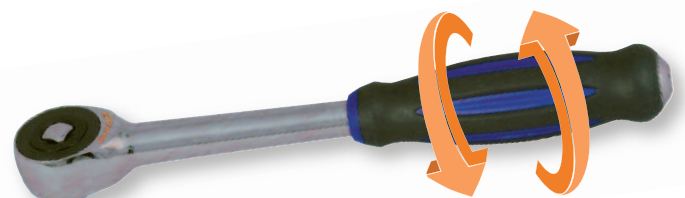

1/4" BIT-Sätze

1/4" Bit Sets



Art-Gruppen 132/133
Article Groups 132/133

3790

PROFESSIONAL PLUS STANDARD



1/4" SECURIBIT-Box 75 mm 50-teilig
SECURIBIT-Set 75 mm, 50 pieces

50
tlg./pcs.



3788

PROFESSIONAL PLUS STANDARD



1/4" Bit Box 75 mm, 36-teilig
Bit Set, 36 pieces

36
tlg./pcs.



3	☉	Schlitz/Slotted	4 - 5 - 6 mm
2	⊕	Phillips/PH	PH 1 - 2
2	⊕	Pozidriv/PZ	PZ 1 - 2
3	⊙	Inbus/Hex	4 - 5 - 6 mm
6	⊙	Inbus mit Bohrung/ Tamper Hex	2 - 2,5 - 3 - 4 - 5 - 6 mm
5	⊗	TORX®/TX	T10 - 15 - 20 - 25 - 30
9	⊗	TORX® mit Bohrung/ Tamper TX	T8 - 10 - 15 - 20 - 25 - 27 - 30 - 35 - 40
2	□	Robertson	Nr. 1 - 2
3	⊕	Torg	6 - 8 - 10 mm
4	⊕	Tri-Wing	Nr. 1 - 2 - 3 - 4
4	⊕	Spanner	4 - 6 - 8 - 10 mm
3	⊕	Clutch	Nr. 1 - 2 - 3
1		Magnethalter	

Bits aus CRV-Stahl · Gewicht/Weight: 900 g

Art.-Nr./Art.-No.	G./S.	tlg./pcs	B	L	H
3790	1/4"	50	193	137	36

4	☉	Schlitz/Slotted	3 - 4 - 5 - 6 mm
5	⊕	Phillips/PH	2 x PH 1 - 2, 1 x PH 3
5	⊕	Pozidriv/PZ	2 x PZ 1 - 2, 1 x PZ 3
7	⊗	TORX®/TX	T10 - 15 - 20 - 25 - 27 - 30 - 40
8	⊗	TORX® mit Bo./Tamper TX	T8 - 10 - 15 - 20 - 25 - 27 - 30 - 40
6	⊙	Inbus/Hex	2 - 2,5 - 3 - 4 - 5 - 6 mm
1		Magnethalter	

Bits aus CRV-Stahl · Gewicht/Weight: 720 g

Art.-Nr./Art.-No.	G./S.	tlg./pcs	B	L	H
3788	1/4"	36	190	130	36

1/4" BIT-Sätze

1/4" Bit Sets



Art.-Gruppe 133
Article Group 133

3789 PROFESSIONAL PLUS STANDARD



1/4" SECURIBIT Box
„zu jeder Schraube den richtigen Bit“
SECURIBIT Set „for every screw the right bit“

122
tlg./pcs.



3787 PROFESSIONAL PLUS STANDARD



1/4" SECURIBIT Box
„zu jeder Schraube den richtigen Bit“
SECURIBIT Set „for every screw the right bit“

100
tlg./pcs.



9	☉	Schlitz/Slotted	3 - 4 - 4,5 - 5 - 5,5 - 6 - 6,5 - 7 - 8
5	⊕	Phillips/PH	PH 00 - 0 - 1 - 2 - 3
5	⊕	Pozidriv	PZ 00 - 0 - 1 - 2 - 3
9	⊙	Inbus/Hex	1,5 - 2 - 2,5 - 3 - 4 - 5 - 5,5 - 6 - 8 mm
10	⊙	Inbus/Hex	1/16" - 5/64" - 3/32" - 7/64" - 1/8" - 9/64" - 5/32" - 3/16" - 7/32" - 1/4"
6	⊙	Inbus mit Bohrung	2 - 2,5 - 3 - 4 - 5 - 6 mm
9	⊙	5-Stern mit Bohrung	TS10 - 15 - 20 - 25 - 27 - 30 - 40 - 45 - 50
13	⊙	TORX®/TX	T5 - 6 - 7 - 8 - 9 - 10 - 15 - 20 - 25 - 27 - 30 - 40 - 45
9	⊙	TORX® mit Bohrung/ Tamper TX	T8 - 10 - 15 - 20 - 25 - 27 - 30 - 35 - 40
4	⊕	Robertson	Nr. 0 - 1 - 2 - 3
3	⊕	Torg	6 - 8 - 10 mm
4	⊕	Tri-Wing	Nr. 1 - 2 - 3 - 4
4	⊕	Spanner	4 - 6 - 8 - 10 mm
3	⊕	Clutch	Nr. 1 - 2 - 3
3	⊕	Vielzahn	M5 - 6 - 8
10	⊕	Stecknuss Bit	4 - 5 - 6 - 7 - 8 - 9 - 10 - 11 - 12 - 13 mm
10	⊕	Stecknuss Bit	5/32" - 3/16" - 7/32" - 1/4" - 9/32" - 5/16" - 11/32" - 3/8" - 7/16" - 1/2"
1		Eindreh-Bit für Haken	
1		Magnethalter	
1		Universal Bit- Schraubendreher mit Dauermagnet	
1		Bit Adapter	1/4" x 1/4"
2		Stecknuss Adapter	25 + 50 mm

Bits aus CRV-Stahl · Gewicht/Weight: 1.160 g

Art.-Nr./Art.No.	G./S.	tlg./pcs	B	L	H
3789	1/4"	122	220	155	50

9	☉	Schlitz/Slotted	3 - 4 - 4,5 - 5 - 5,5 - 6 - 6,5 - 7 - 8
8	⊕	Phillips/PH	PH 0 - 1 - 3, 5 x PH 2
8	⊕	Pozidriv	PZ 0 - 1 - 3, 5 x PZ 2
9	⊙	Inbus/Hex	1,5 - 2 - 2,5 - 3 - 4 - 5,5 - 6 - 8 mm
10	⊙	Inbus/Hex	1/16" - 5/64" - 3/32" - 7/64" - 1/8" - 9/64" - 5/32" - 3/16" - 7/32" - 1/4"
6	⊙	Inbus mit Bohrung	2 - 2,5 - 3 - 4 - 5 - 6 mm
6	⊙	Inbus mit Bohrung	5/64" - 3/32" - 7/64" - 1/8" - 9/64" - 5/32"
9	⊙	TORX®/TX	T8 - 10 - 15 - 20 - 25 - 27 - 30 - 35 - 40
9	⊙	TORX® mit Bohrung/ Tamper TX	T8 - 10 - 15 - 20 - 25 - 27 - 30 - 35 - 40
4	⊕	Robertson	Nr. 0 - 1 - 2 - 3
3	⊕	Torg	6 - 8 - 10 mm
4	⊕	Tri-Wing	Nr. 1 - 2 - 3 - 4
4	⊕	Spanner	4 - 6 - 8 - 10 mm
3	⊕	Clutch	Nr. 1 - 2 - 3
3	⊕	Vielzahn	M5 - 6 - 8
1		Eindreh-Bit für Haken	
1		Magnethalter	
1		Bit Adapter	1/4" x 1/4"
2		Stecknuss Adapter	25 + 50 mm

Bits aus CRV-Stahl · Gewicht/Weight: 700 g

Art.-Nr./Art.No.	G./S.	tlg./pcs	B	L	H
3787	1/4"	100	190	130	36

1/4" BIT-Sätze

1/4" Bit Sets



Art.-Gruppe 133
Article Group 133

8604

PROFESSIONAL PLUS STANDARD

113
tlg./pcs.



1/4" Bit Box XL, 113-teilig

Bit Set „BIT Box XL“ with 113 pieces



25 mm

- | | | | |
|----|---|-----------------------------|--|
| 7 | ☉ | Schlitz/Slotted | 4 - 4 - 4 - 6 - 6 - 6 - 6 mm |
| 14 | ⊕ | Phillips/PH | 4x PH 1 - 7x PH 2 - 3x PH 3 |
| 14 | ⊕ | Pozidriv/PZ | 4x PZ 1 - 7x PZ 2 - 3x PZ 3 |
| 7 | ⊙ | Inbus/Hex | 4 - 4 - 5 - 5 - 5 - 6 - 6 mm |
| 49 | ⊗ | TORX®/TX | 7x TX10 - 15 - 20 - 25 -
27 - 30 - 40 |
| 7 | ⊗ | TORX® mit Bo./
Tamper TX | TX10 - 15 - 20 - 25 -
27 - 30 - 40 |

75 mm

- | | | | |
|---|---|-----------------------------------|---------------------------|
| 4 | ⊕ | Phillips/PH | PH 1 - PH 2 - PH 2 - PH 3 |
| 4 | ⊕ | Pozidriv/PZ | PZ 1 - PZ 2 - PZ 2 - PZ 3 |
| 5 | ⊗ | TORX®/TX | TX10 - 15 - 20 - 25 - 30 |
| 1 | | Bit Magnethalter | |
| 1 | | Bit Halter mit Schnellspannfutter | |

Bits aus CRV-Stahl

Größe/Size: 1/4" · tlg./pcs 113 · BxLxH/WxLxH: 120x205x45 mm

Gewicht/Weight: 1.120 g

Art.-Nr./Art.-No.	G./S.	tlg./pcs	B	L	H
8604	1/4"	113	205	120	45

1/4" BIT-Sätze

1/4" Bit Sets

1/4"

Art.-Gruppe 133
Article Group 133

8606

PROFESSIONAL PLUS STANDARD

200
tlg./pcs.

1/4"

1/4" Bit-Box XXL, 200-teilig „zu jeder Schraube den richtigen Bit“

Bit Box XXL 200 pieces

„for every screw the right bit“



25 mm

12	☉	Schlitz/Slotted	2 - 2,5 - 3 - 3,5 - 4 - 4,5 - 5 - 5,5 - 6 - 6,5 - 7 - 8 mm
18	+	Phillips/PH	1x PH 00 - 1x PH 0 - 5x PH 1 - 5x PH 2 - 5x PH 3 - 1x PH 4
17	+	Pozidriv/PZ	1x PZ 00 - 1x PZ 0 - 5x PZ 1 - 5x PZ 2 - 4x PZ 3 - 1x PZ 4
12	⊙	Inbus/Hex	1,5 - 2 - 2,5 - 3 - 3,5 - 4 - 4,5 - 5 - 5,5 - 6 - 7 - 8 mm
10	⊙	Inbus/Hex	1/16" - 5/64" - 3/32" - 7/64" - 1/8" - 9/64" - 5/32" - 3/16" - 7/32" - 1/4"
6	⊙	Inbus mit Bohrung	2 - 2,5 - 3 - 4 - 5 - 6 mm
6	⊙	Inbus mit Bohrung	5/64" - 3/32" - 7/64" - 1/8" - 9/64" - 5/32"
9	☆	5-Stern mit Bohrung	TS10 - 15 - 20 - 25 - 27 - 30 - 40 - 45 - 50
13	★	TORX®/TX	T5 - 6 - 7 - 8 - 9 - 10 - 15 - 20 - 25 - 27 - 30 - 40 - 45
14	★	TORX® mit Bo./Tampertx	T5 - 6 - 7 - 8 - 9 - 10 - 15 - 20 - 25 - 27 - 30 - 35 - 40 - 45
4	□	Robertson	Nr. 0 - 1 - 2 - 3
3	+	Torg	6 - 8 - 10 mm
4	↻	Tri-Wing	Nr. 1 - 2 - 3 - 4
4	⊙	Spanner	4 - 6 - 8 - 10 mm
3	⊙	Clutch	Nr. 1 - 2 - 3
3	⊙	Vielzahn	M5 - 6 - 8

50 mm

2	+	Phillips/PH	PH 2 - 3
2	+	Pozidriv/PZ	PZ 2 - 3
4	⊙	Inbus/Hex	3 - 4 - 5 - 6 mm
7	★	TORX® mit Bohrung/Tampertx	T10 - 15 - 20 - 25 - 27 - 30 - 40
3	+	Torg	6 - 8 - 10 mm
4	↻	Tri-Wing	Nr. 1 - 2 - 3 - 4
4	⊙	Spanner	4 - 6 - 8 - 10 mm

75 mm

2	+	Phillips/PH	PH 2 - 3
4	⊙	Inbus/Hex	3 - 4 - 5 - 6 mm
7	★	TORX® mit Bohrung/Tampertx	T10 - 15 - 20 - 25 - 27 - 30 - 40

38 mm

10		Stecknuss Bit	4 - 5 - 6 - 7 - 8 - 9 - 10 - 11 - 12 - 13 mm
10		Stecknuss Bit	5/32" - 3/16" - 7/32" - 1/4" - 9/32" - 5/16" - 11/32" - 3/8" - 7/16" - 1/2"
1		Magnethalter 60 mm	
1		Magnethalter mit Schnellspannfutter 65 mm	
1		Stecknuss Adapter 1/4" 25 mm	

Bits aus CV-Stahl

Größe/Size: 1/4" · tlg./pcs 200 · BxLxH/WxLxH: 220x155x50 mm

Gewicht/Weight: 2.000 g

Art.-Nr./Art.-No.	G./S.	tlg./pcs	B	L	H
8606	1/4"	200	335	200	45

1/4" BIT-Sätze

1/4" Bit Sets



Art.-Gruppen 130/131
Article Groups 130/131

PROFESSIONAL PLUS STANDARD

1/4" Stecknuss Bit Adapter Satz, 3-tlg. 50 mm für Stecknüsse 1/4", 3/8", 1/2"

Bit Adapter Set, 3 pieces

50 mm For Sockets 1/4", 3/8", 1/2"



Art.-Nr./Art.-No.	Größe/Size	Länge/Length
2880	1/4" x 1/4"	50 mm
	1/4" x 3/8"	50 mm
	1/4" x 1/2"	50 mm

PROFESSIONAL PLUS STANDARD

1/4" Sätze Stecknuss Bit mit Magnet, 65 mm 1/4" Magnetic Nut Setter Sets, 65 mm



Abb. ähnlich / picture similar

Art.-Nr./Art.-No.	Größe/Size
3784-91	7 - 8 - 10 - 13 mm (4-tlg. Satz)
3784-92	1/4" - 3/8" - 5/16" (3-tlg. Satz)
3784-93	5,5 - 6 - 7 - 8 - 10 - 12 - 13 - 17 mm (8-tlg. Satz)

Bit-Display / Magazin

Bit Display / Storage



**Fragen Sie nach unseren Bestückungen –
das Display kann auch individuell nach
Kundenwunsch bestückt werden!**

Please ask for different contents –
the display content can be individualised due to your needs!

Art.-Gruppe 131
Article Group 131

11911-01

615 x 503 x 150 mm

Reihe 1/Line 1:

- ⊕ 25 mm 30 x PH1 - 50 x PH2 - 30 x PH3
- ⊕ 25 mm TiN 20 x PH1 - 30 x PH2 - 20 x PH3
- ⊕ 50 mm 20 x PH2
- ⊕ 25 mm 10 x Schraubvorsatz mit Tiefenstopp PH2
- 50 mm Stecknuss Bit Adapter 1/4" x 1/4"

Reihe 3/Line 3:

- ⊕ 25 mm 20 x TX10 - 20 x TX15 - 50 x TX20 - 50 x TX 25 - 50 x TX30 - 20 x TX 40
- ⊕ 25 mm TiN 30 x TX15 - 30 x TX 20 - 30 x TX 25

Reihe 2/Line 2:

- ⊕ 25 mm 30 x PZ1 - 50 x PZ2 - 30 x PZ3
- ⊕ 25 mm TiN 20 x PZ1 - 30 x PZ2 - 20 x PZ3
- ⊕ 50 mm 10 x PZ1 - 20 x PZ2 - 10 x PZ3

Reihe 4/Line 4:

- 65 mm Stecknuss Bit 6 x 8 mm - 6 x 10 mm - 5 x 13 mm
- 10 x Bit Magnethalter
- 10 x Magnethalter mit Schnellspannfutter
- 10 x Magnethalter mit „Ring-Magnet“

Art.-Nr./Art.-No.	tlg./pcs.	€
11911-01	787	bestückt mit 787 Bits / with 787 Bits

Schraubendreher & Winkelstiftschlüssel

Screwdriver & Hex Keys

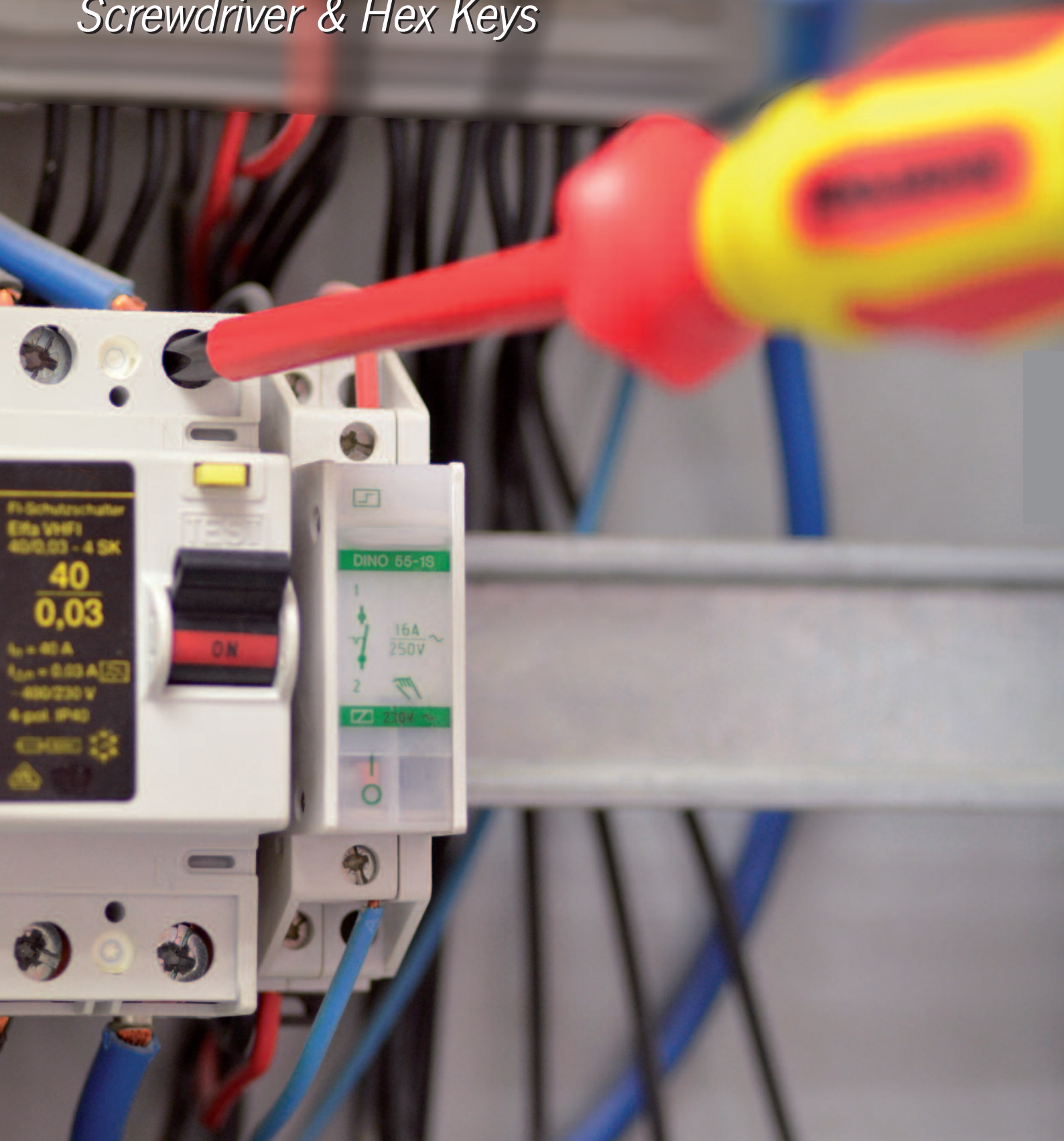

Schraubendreher – Die ergonomischen Allrounder

Screwdriver – The ergonomic all-rounders



Ergonomisch

Ergonomic

- ▶ **Hohe Kraftübertragung durch optimale Anpassung des Mehrkomponentengriffs an die Hand**
 - ▶ **Kein Durchrutschen der Hand auf Grund der Kombination weicher und fester Werkstoffe für den Griff**
 - ▶ **Rutschfeste Oberfläche minimiert das Durchrutschen der Hand auch bei öligen oder fettigen Händen**
 - ▶ **Optimale Kraftübertragung von Griff auf Klinge durch komplett in den Griff eingearbeiteten Klingenschaft**
 - ▶ **6-kant Schlüsselhilfe ermöglicht das Lösen von extrem fest sitzenden Schrauben (Ausführung mit Schlagkappe)**
- ▶ High power transmission due to a optimized multi-component handle
- ▶ No slipping of the hand because of a combination of soft and hard materials for the handle
- ▶ Non-slip surface minimizes slipping also with oily or greasy hands
- ▶ Optimized power transmission due to a secure connection between handle and blade
- ▶ Hexagonal holding fixture enables the loosen of jammed screws (Version with impact cap)

Vielseitig

Versatile

- ▶ **Für jeden Anwender der richtiger Schraubendreher durch breites Produktsortiment**
 - ▶ **Für sicheres Arbeiten an elektrischen Anlagen als VDE-Version erhältlich**
 - ▶ **Für härteste Anwendungen auch als Version mit Schlagkappe**
 - ▶ **6-in-1 Universal Schraubendreher für PH- und PZ-Schrauben der Größen 1 bis 3 – ein Schraubendreher für 6 Anwendungen**
 - ▶ **Große Produktauswahl an perfekt abgestimmten Sets**
- ▶ For every user the right screwdriver due to a wide product range
- ▶ As VDE-Versions available – Safety working on electrical installations
- ▶ For extreme demanding applications also as version with impact cap available
- ▶ 6-in-1 Universal Screwdriver for PH- and PZ-Drives with sizes from 1 to 3 – only one screwdriver for 6 applications
- ▶ Wide product range of perfect customized sets



Strapazierfähig und langlebig

Hardwearing and Durable

- ▶ **Speziell für den professionellen Einsatz durch hochlegierten Spezialstahl geeignet**
 - ▶ **Langlebige und stabile Klingenspitze durch optimierte Klingeneigenschaften in Bezug auf Härte und Zähigkeit**
 - ▶ **Weniger Verschleiß an Klingenspitze und Schraube durch präzise ausgearbeitete Klinge**
 - ▶ **Für besonders hohe Belastungen und Schlagkappe erhältlich**
- ▶ Especially for the professional usage due to high alloyed special steel
- ▶ Durable and robust tip because of an optimized hardness of the material
- ▶ Less wearing at the tip and the screw due to a high quality blade tip
- ▶ Version with impact cap for extreme demanding applications

Sicherheit

Safety

- ▶ **Höchste Sicherheit bei Arbeiten an elektrischen Anlagen durch Prüfung nach DIN-EN 60900 und IEC 900 (VDE-Ausführung)**
 - ▶ **Verminderung der Abrutschgefahr der Hand durch optimierte Griffform**
- ▶ Highest safety during working on electrical installations due to tests according to DIN-EN 60900 and IEC 900 (VDE-Version)
- ▶ Optimized handle reduces the risk of slipping

* Phillips® und Pozidriv® sind eingetragene Markenzeichen der Firma Phillips Screw Co.
TORX® und tamper TORX® sind eingetragene Markenzeichen der Firma Camcar/Textron

* Phillips® and Pozidriv® are registered trademarks of the company Phillips Screw Co.
TORX® and tamper TORX® are registered trademarks of the company Camcar/Textron

Schraubendreher für Schlitz-Schrauben

Slotted Screwdriver



Art.-Gruppen 140/145
Article Groups 140/145

Schraubendreher für Schlitz-Schrauben

Slotted Screwdriver



Art.-Nr./Art.-No.	Klingenstärke/Blade Thickness	Klingenbreite/Blade Width	Klingenlänge/Blade Length	€
4620-01	0,5 mm	3,0 mm	75 mm	
4620-02	0,8 mm	4,0 mm	100 mm	
4620-03	1,0 mm	5,5 mm	125 mm	
4620-04	1,2 mm	6,5 mm	150 mm	
4620-05	1,2 mm	8,0 mm	175 mm	
4622-01	1,2 mm	6,5 mm	25 mm	

Schraubendreher für Schlitz-Schrauben mit Schlagkappe

Slotted Screwdriver with Impact Cap



inkl. Schlüsselhilfe
incl. Wrench Adapter

Robuste Schlagkappe
Impact Cap

Art.-Nr./Art.-No.	Klingenstärke/Blade Thickness	Klingenbreite/Blade Width	Klingenlänge/Blade Length	SW/Size	€
5120-02	0,8 mm	4,5 mm	90 mm	8 mm	
5120-03	1,0 mm	5,5 mm	100 mm	10 mm	
5120-04	1,2 mm	7,0 mm	125 mm	10 mm	
5120-05	1,2 mm	8,0 mm	150 mm	13 mm	

Schraubendreher für Schlitz-Schrauben

Slotted Screwdriver



Art.-Nr./Art.-No.	Klingenstärke/Blade Thickness	Klingenbreite/Blade Width	Klingenlänge/Blade Length	€
4120-01	0,5 mm	3,0 mm	75 mm	
4120-02	0,8 mm	4,0 mm	100 mm	
4120-03	1,0 mm	5,5 mm	125 mm	
4120-04	1,2 mm	6,5 mm	150 mm	
4120-05	1,6 mm	8,0 mm	150 mm	
4120-06	1,6 mm	10,0 mm	200 mm	
4121-02	0,8 mm	4,0 mm	125 mm	Elektriker
4121-03	1,0 mm	5,5 mm	150 mm	Elektriker
4122-01	1,2 mm	6,5 mm	38 mm	Vergaser

Schraubendreher für Kreuzschlitz-Schrauben Phillips

Phillips Screwdriver



Art.-Gruppen 140/145
Article Groups 140/145

Schraubendreher für Kreuzschlitz-Schrauben Phillips

Phillips Screwdriver +



Art.-Nr./Art.-No.	Größe/Size	Klingenlänge/Blade Length	€
4600-00	0	60 mm	
4600-01	1	80 mm	
4600-02	2	100 mm	
4600-03	3	150 mm	
4602-01	1	25 mm	
4602-02	2	25 mm	

Schraubendreher für Kreuzschlitz-Schrauben Phillips mit Schlagkappe

Phillips Screwdriver with Impact Cap +



inkl. Schlüsselhilfe
incl. Wrench Adapter



Robuste Schlagkappe
Impact Cap



Art.-Nr./Art.-No.	Größe/Size	Klingenlänge/Blade Length	Schlüsselhilfe/Wrench Adapter	€
5100-01	1	80 mm	8 mm	
5100-02	2	100 mm	10 mm	

Schraubendreher für Kreuzschlitz-Schrauben Phillips

Phillips Screwdriver +



Art.-Nr./Art.-No.	Größe/Size	Klingenlänge/Blade Length	€	Art.-Nr./Art.-No.	Größe/Size	Kl./Bl	€
4100-00	0	60 mm		4102-02	2	38 mm	Vergaser
4100-01	1	80 mm					
4100-02	2	100 mm					
4100-03	3	150 mm					

Schraubendreher für Kreuzschlitz-Schrauben Pozidriv

Pozidriv Screwdriver



Art.-Gruppen 140/145
Article Groups 140/145

Schraubendreher für Kreuzschlitz-Schrauben Pozidriv

Pozidriv Screwdriver



Art.-Nr./Art.-No.	Größe/Size	Klingenlänge/Blade Length	€
4610-00	0	60 mm	
4610-01	1	80 mm	
4610-02	2	100 mm	
4610-03	3	150 mm	

Schraubendreher für Kreuzschlitz-Schrauben Pozidriv

Pozidriv Screwdriver

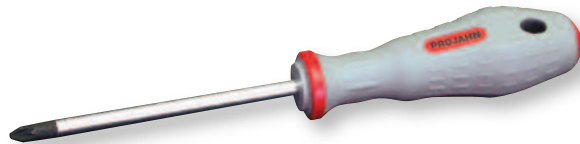

Art.-Nr./Art.-No.	Größe/Size	Klingenlänge/Blade Length	€
4110-00	0	60 mm	
4110-01	1	80 mm	
4110-02	2	100 mm	
4110-03	3	150 mm	

6-in-1 Universal Schraubendreher für Kreuzschlitz-Schrauben Phillips und Pozidriv

6-in-1 Universal Phillips and Pozidriv Screwdriver



► Ein Schraubendreher für 6 Schraubenantriebe:

Phillips 1 - 2 - 3 und Pozidriv 1 - 2 - 3

► One Screwdriver for 6 screw drives:

PH 1 - 2 - 3 and PZ 1 - 2 - 3



Art.-Nr./Art.-No.	Größe/Size	Klingenlänge/Blade Length	€
4600-1230	PH 1 - 3 / PZ 1 - 3	100 mm	
4600-1231	PH 1 - 3 / PZ 1 - 3	25 mm	

Schraubendreher für Innen-TX-Schrauben

Tamper TX Screwdriver



Art.-Gruppen 140/145
Article Groups 140/145

Schraubendreher für Innen-TX-Schrauben

TX Screwdriver



Art.-Nr./Art.-No.	Größe/Size	Klingenlänge/Blade Length	€
4630-08	T8	60 mm	
4630-10	T10	80 mm	
4630-15	T15	80 mm	
4630-20	T20	100 mm	

Art.-Nr./Art.-No.	Größe/Size	Klingenlänge/Blade Length	€
4630-25	T25	100 mm	
4630-27	T27	115 mm	
4630-30	T30	115 mm	
4630-40	T40	130 mm	

Schraubendreher für Innen-TX-Schrauben

TX Screwdriver

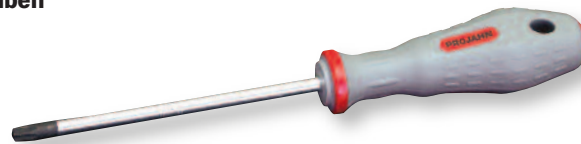

Art.-Nr./Art.-No.	Größe/Size	Klingenlänge/Blade Length	€
4130-05	T5	50 mm	
4130-06	T6	60 mm	
4130-07	T7	60 mm	
4130-08	T8	60 mm	
4130-09	T9	60 mm	
4130-10	T10	80 mm	

Art.-Nr./Art.-No.	Größe/Size	Klingenlänge/Blade Length	€
4130-15	T15	80 mm	
4130-20	T20	80 mm	
4130-25	T25	100 mm	
4130-27	T27	115 mm	
4130-30	T30	115 mm	
4130-40	T40	130 mm	

Schraubendreher für Innen-TX-Schrauben mit stirnseitiger Bohrung

Tamper TX Screwdriver

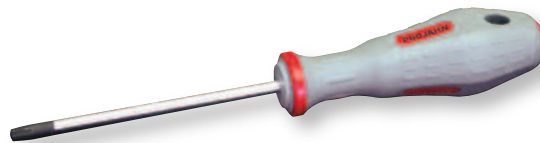

Art.-Nr./Art.-No.	Größe/Size	Klingenlänge/Blade Length	€
4150-08	T8	60 mm	
4150-10	T10	80 mm	
4150-15	T15	80 mm	
4150-20	T20	100 mm	

Art.-Nr./Art.-No.	Größe/Size	Klingenlänge/Blade Length	€
4150-25	T25	100 mm	
4150-27	T27	115 mm	
4150-30	T30	115 mm	
4150-40	T40	130 mm	

Universal Schraubendreher

Universal Screwdriver



Art.-Gruppen 140/145
Article Groups 140/145

Schraubendreher mit Sechskant Steckschlüssel, Flexibler Schaft

Hex Metric Screwdriver, Flexible



Art.-Nr./Art.-No.	Größe/Size	Länge/Length	€
4692-06	6 mm	150 mm	
4692-07	7 mm	150 mm	
4692-08	8 mm	150 mm	

Schraubendreher mit 1/4" Bit Schnellspannfutter

Quick Release Bit Screwdriver



Art.-Nr./Art.-No.	Größe/Size	€
4690-02	1/4" mit Schnellspannfutter	

Ratschenschraubendreher mit 1/4" Bit Magnethalter und 10 Color-Bits

Magnetic Bit Ratchet Screwdriver with 10 Color Bits



- ▶ Mit Ratschenfunktion
- ▶ Ratschenfunktion rechts/links umschaltbar
- ▶ With ratchet function
- ▶ Ratchet function right/left reversible

2	⊖	Schlitz/Slotted (rot/red)	4 - 5 mm
2	⊕	Phillips/PH (dunkelrot/dark red)	PH 1 - 2
2	⊕	Pozidriv/PZ (blau/blue)	PZ 1 - 2
2	⊕	TORX®/TX (gelb/yellow)	TX20 - 25
2	⊙	Inbus/Hex (orange)	3 - 5 mm
1		Ratschenschraubendreher	

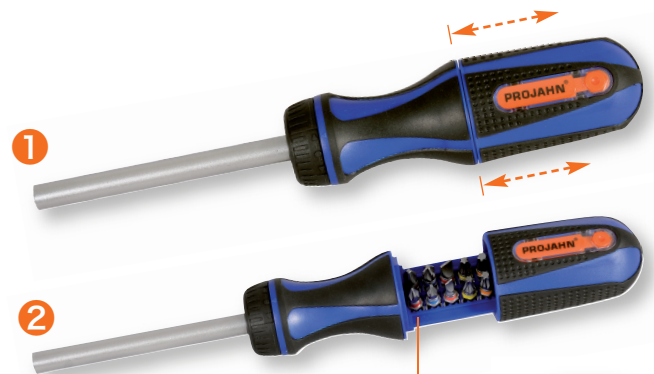

215 x 160 x 245 mm
Art. 419212
Display mit /with 12x 4192

Art.-Nr./Art.-No.	Größe/Size	€
4192	1/4" Ratschenschraubendreher inkl. 10 Color-Bits/Ratchet Screwdriver incl. 10 Color-Bits	
419212	Display mit /with 12 x 4192 (1/4" Ratschenschraubendreher/Ratchet Screwdriver)	

Präzisions-Schraubendrehersätze und Spannungsprüfer

Precision Screwdriver Sets and Voltage Tester



Art-Gruppen 140/145
Article Groups 140/145

PROFESSIONAL **PLUS** STANDARD



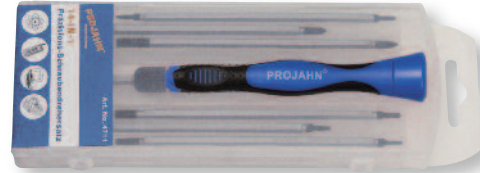

4711

Präzisions-Schraubendreher Satz

Precision Screwdriver Set   



8
tlg./pcs.

Art.-Nr./Art.-No.	Größe/Size	Klingenlänge/Blade Length	€
4711	PH00 x  2 mm / PH0 x  3 mm / PH1 x  4 mm  T6 x T10 - T7 x T15 - T8 x T20 - T9 x T15	Doppelklingen 120mm	

PROFESSIONAL **PLUS** STANDARD

NEU/NEW





4714

30-in-1 Präzisions-Bit-Schraubendreher Satz

30-in-1 Precision Bit Screwdriver Set



31
tlg./pcs.

7	 Schlitz/Slotted	1 - 1,5 - 2 - 2,5 - 3 - 3,5 - 4 mm
4	 Phillips/PH	PH 000 - 00 - 0 - 1
2	 Pozidriv/PZ	PZ 0 - 1
9	 TORX®/TX	TX4 - 5 - 6 - 7 - 8 - 9 - 10 - 15 - 20
8	 Inbus/Hex	0,7 - 0,9 - 1,3 - 1,5 - 2 - 2,5 - 3 - 4 mm
1	Präzisions-Bit-Schraubendreher/Precision Bit Screwdriver	

Art.-Nr./Art.-No. €
4714

PROFESSIONAL PLUS **STANDARD**

EURO-Spannungsprüfer nach VDE 0680

Voltage Tester 



  **1000V**
EN 60900

Art.-Nr./Art.-No.	Größe/Size	€
2137	3,0 x 60 mm 125 - 250 V	

PROFESSIONAL PLUS **STANDARD**

Phasenprüfer 230 V

Voltage Tester 



  **1000V**
EN 60900

Art.-Nr./Art.-No.	Größe/Size	€
2138	3,0 x 60 mm 110 - 230 V	

VDE-Schraubendreher/Schraubendrehersortiment

Safety Insulated Screwdriver/Set



Art-Gruppe 145
Article Group 145

Nach DIN EN 60900, IEC 900, Stückprüfung im Wasserbad mit einer Prüfspannung von 10.000 Volt. Kälteschlagprüfung bei -40° (Kennzeichnung C)

According to DIN EN 60900, IEC 900. Tested by 10.000 Volt.

VDE Schraubendreher für Kreuzschlitz-Schrauben Phillips

Phillips VDE Screwdriver



Art.-Nr./Art.-No.	Größe/Size	Klingenlänge/Blade Length	€
5105-00	0	60 mm	
5105-01	1	80 mm	
5105-02	2	100 mm	

VDE Schraubendreher für Kreuzschlitz-Schrauben Pozidriv

Pozidriv VDE Screwdriver



Art.-Nr./Art.-No.	Größe/Size	Klingenlänge/Blade Length	€
5115-00	0	60 mm	
5115-01	1	80 mm	
5115-02	2	100 mm	

VDE Schraubendreher für Schlitz-Schrauben

Slotted VDE Screwdriver



Art.-Nr./Art.-No.	Klingenstärke/Blade Thickness	Klingenbreite/Blade Width	Klingenlänge/Blade Length	€
5125-01	0,4 mm	2,5 mm	75 mm	
5125-03	0,6 mm	3,5 mm	100 mm	
5125-04	0,8 mm	4,0 mm	100 mm	
5125-05	1,0 mm	5,5 mm	125 mm	
5125-06	1,2 mm	6,5 mm	150 mm	

6-in-1 Universal VDE Schraubendreher für Kreuzschlitz-Schrauben Phillips und Pozidriv

6-in-1 Universal VDE Phillips and Pozidriv Screwdriver

- Ein Schraubendreher für 6 Schraubenantriebe:
Phillips 1 - 2 - 3 und Pozidriv 1 - 2 - 3

- One Screwdriver for 6 screw drives:
PH 1 - 2 - 3 and PZ 1 - 2 - 3



Art.-Nr./Art.-No.	Größe/Size	Klingenlänge/Blade Length	€
5105-1230	PH 1 - 3 / PZ 1 - 3	100 mm	

VDE Schraubendreher Satz, 7-teilig

VDE Screwdriver Sets, 7 pieces



7
tlg./pcs.

Art.-Nr./Art.-No.	Größe/Size	€
5190	0,4 x 2,5 - 0,8 x 4,0 - 1,0 x 5,5 - 1,2 x 6,5 mm PH 1 - 2, Spannungsprüfer 230 V	

VDE Werkzeugsätze

VDE Tool Sets

Art.-Gruppe 113/145
Article Group 113/145

8687

PROFESSIONAL PLUS STANDARD

NEU/NEW

VDE Elektriker-Werkzeugmappe

VDE Electrical Tool Bag



12
tlg./pcs.

PROJAHN
proficraft

- ▶ Alle wichtigen Elektrowerkzeuge im Set
- ▶ Ideal für Elektro-, Heizung-, Sanitär-, Klima- und Belüftungstechnik
- ▶ Alle Werkzeuge VDE-geprüft nach DIN EN ISO 60900 bis 1.000 V
- ▶ Hochwertige Verarbeitung und Materialien, ergonomisches Design
- ▶ All important electrical tools in one set
- ▶ Designed for electrical engineering, heating systems, sanitary installation, climate control and ventilation technology
- ▶ All tools are VDE-tested accordingly DIN ISO 60900 up to 1.000 V
- ▶ High-quality workmanship and materials, Ergonomic design



- 3 ⚙️ Phillips VDE-Schraubendreher PH0 - 1 - 2
- 3 ⚙️ Schlitz VDE-Schraubendreher 2,5 - 4 - 6,5 mm
- 1 Spannungsprüfer 125 - 250 V
- 1 VDE Abisolierzange 150 mm
- 1 VDE Elektriker-Messer 150 mm
- 1 VDE Kombizange 150 mm
- 1 VDE Seitenschneider 150 mm
- 1 VDE Telefonzange 200 mm

Art.-Nr./Art.-No.

8687

5195

PROFESSIONAL PLUS STANDARD

NEU/NEW

VDE-Wechselklingen-Schraubendreher-Set

Electrical Screwdriver Set with interchangeable Blades



12
tlg./pcs.

- ▶ Alle wichtigen VDE-Schraubendreher im handlichen Set
- ▶ Schnelles und sicheres Wechseln durch patentiertes Wechselklingensystem
- ▶ Durch aufsteckbare Drehkappe und Weichmantelzone auch ideal für die Feinelektronik
- ▶ Sicherheitsgeprüft nach DIN ISO 60900 bis 1.000 V
- ▶ Handlicher, rutschfester Griff
- ▶ In exklusiver, praktischer und platzsparender Gürtel-Rolltasche
- ▶ Reduziere Gefahr von Kratzern auf empfindlichen Untergründen
- ▶ All important VDE screwdrivers in one ergonomic set
- ▶ Patented changeable system for a safety and fast change of the blade
- ▶ Secure fit of blades, quickrelease button on handle against unwanted extraction
- ▶ Precision cap and soft-crip zone on blade for low torque application
- ▶ Due to push-on twist cap and soft-grip zone also ideal for fine electronic engineering
- ▶ Safety tested accordingly DIN ISO 60900 up to 1.000 V
- ▶ Ergonomic and non-slip handle
- ▶ In exclusive, practically and space-saving roll bag
- ▶ Roll bag reduces the risk of scratches on sensitive surfaces



- 5 ⚙️ 2,5 x 0,4 / 3,0 x 0,5 / 3,5 x 0,6 / 4,0 x 0,8 / 5,5 x 1,0 mm
- 2 ⚙️ PH1 - PH 2 1 Wechselgriff
- 1 ⚙️ PZ 2 1 Drehkappe
- 2 ⚙️ TX15 - 20

Art.-Nr./Art.-No.

5195

Quergriff-Schraubendreher

T-Handle Screwdriver



Art.-Gruppe 140
Article Group 140

PROFESSIONAL PLUS STANDARD

Quergriff Schraubendreher mit Kugelkopf für Innensechskant-Schrauben

T-Handle Screwdriver Ball Point



Art.-Nr./Art.-No.	Größe/Size	Länge/Length	€
4170-2	2,0 mm	100 mm	
4170-25	2,5 mm	100 mm	
4170-3	3,0 mm	100 mm	
4170-4	4,0 mm	150 mm	
4170-5	5,0 mm	150 mm	
4170-6	6,0 mm	200 mm	
4170-8	8,0 mm	200 mm	
4170-10	10,0 mm	200 mm	

PROFESSIONAL PLUS STANDARD

Quergriff Schraubendreher für Innen-TX-Schrauben

T-Handle Screwdriver TX

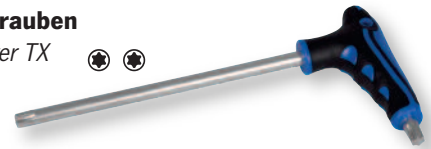

Art.-Nr./Art.-No.	Größe/Size	Länge/Length	€
4180-10	TX 10	100 mm	
4180-15	TX 15	100 mm	
4180-20	TX 20	100 mm	
4180-25	TX 25	100 mm	
4180-27	TX 27	100 mm	
4180-30	TX 30	150 mm	
4180-40	TX 40	150 mm	
4180-45	TX 45	150 mm	
4180-50	TX 50	150 mm	

PROFESSIONAL PLUS STANDARD

Quergriff Schraubendreher Satz mit Kugelkopf für Innensechskant-Schrauben

T-Handle Screwdriver Ball Point Set

8
tlg./pcs.



Art.-Nr./Art.-No.	Größe/Size
4170	2 - 2,5 - 3 - 4 - 5 - 6 - 8 - 10 mm

PROFESSIONAL PLUS STANDARD

Quergriff Schraubendreher Satz für Innen-TX-Schrauben

T-Handle Screwdriver TX Set

9
tlg./pcs.



Art.-Nr./Art.-No.	Größe/Size
4180	TX10 - TX15 - TX20 - TX25 - TX27 - TX30 - TX40 - TX45 - TX50

PROFESSIONAL PLUS STANDARD

3-Wege-T-Griff-Schlüssel-Satz, 10-teilig

3-Way T-Handle Socket Set, 10 pieces

NEU/NEW

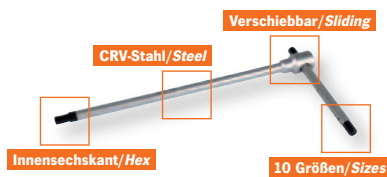

10
tlg./pcs.

Art.-Nr./Art.-No.	Größe/Size	€
394171	2 - 2,5 - 3 - 4 - 5 - 6 - 7 - 8 - 9 - 10 mm	

PROFESSIONAL PLUS STANDARD

3-Wege-T-Griff-Schlüssel-Satz, 10-teilig

3-Way T-Handle Socket Set, 10 pieces

NEU/NEW

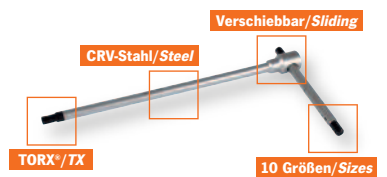

10
tlg./pcs.

Art.-Nr./Art.-No.	Größe/Size	€
394172	T10 - 15 - 20 - 25 - 30 - 35 - 40 - 45 - 50 - 55	

Quergriff-Schraubendreher und Bit-Schraubendreher

T-Handle Screwdriver and Bit Screwdriver



Art-Gruppen 140/145
Article Groups 140/145

Quergriff Schraubendreher mit Sechskant Steckschlüssel

T-Handle Screwdriver

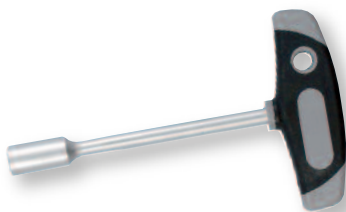

Art.-Nr./Art.-No.	Größe/Size	Länge/Length	€
4690-07	7,0 mm	230 mm	
4690-08	8,0 mm	230 mm	
4690-10	10,0 mm	230 mm	
4690-13	13,0 mm	230 mm	

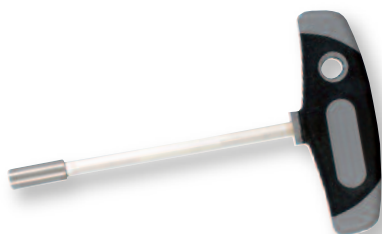

Art.-Nr./Art.-No.	Größe/Size	Länge/Length	€
4691-14	1/4" Bit T-Griff	125 mm	

T-Handle Bit Screwdriver

Magnetische Bit Schraubendreher für Handbetrieb 1/4"

Bit Screwdriver



Art.-Nr./Art.-No.	Größe/Size	€
4190-01	1/4" Bit-Schraubendreher magnetisch	

Magnetic Bit Screwdriver



Art.-Nr./Art.-No.	Größe/Size	€
4690-02	1/4" mit Schnellspannfutter	

Quick Release Bit Screwdriver



Art.-Nr./Art.-No.	Größe/Size	€
4190-03	1/4" kurz mit Schnellspannfutter	

Quick Release Bit Screwdriver, Short Version

Quergriff Schraubendreher für Innensechskant-Schrauben

T-Handle Screwdriver Hex



Art.-Nr./Art.-No.	Größe/Size	Länge/Length	€
4670-02	2,0 mm	100 mm	
4670-25	2,5 mm	100 mm	
4670-03	3,0 mm	100 mm	
4670-04	4,0 mm	150 mm	
4670-05	5,0 mm	150 mm	
4670-06	6,0 mm	200 mm	
4670-08	8,0 mm	200 mm	
4670-10	10,0 mm	200 mm	

Quergriff Schraubendreher für Innen-TX-Schrauben

T-Handle Screwdriver TX



Art.-Nr./Art.-No.	Größe/Size	Länge/Length	€
4680-10	T10	100 mm	
4680-15	T15	100 mm	
4680-20	T20	100 mm	
4680-25	T25	100 mm	
4680-27	T27	150 mm	
4680-30	T30	150 mm	
4680-40	T40	150 mm	

Schraubendrehersätze

Screwdriver Sets



Art.-Gruppe 145
Article Group 145

Schraubendreher Satz
Screwdriver Set



6
tlg./pcs.



Art.-Nr./Art.-No.	Größe/Size
4621	PH 1 - 2 / 0,8 x 4,0 - 1,0 x 5,5 - 1,2 x 6,5 - 1,2 x 8,0 mm Phillips + Schlitz
4622	PZ 1 - 2 / 0,8 x 4,0 - 1,0 x 5,5 - 1,2 x 6,5 - 1,2 x 8,0 mm Pozi driv + Schlitz

Schraubendreher Satz
Screwdriver set



6
tlg./pcs.



Art.-Nr./Art.-No.	Größe/Size
4623	TX10 - TX15 - TX20 - TX25 - TX30 - TX40 TORX®

Schraubendreher Satz
Screwdriver Set



8
tlg./pcs.



Art.-Nr./Art.-No.	Größe/Size
4624	PH 1 - 2 / PZ 1 - 2 / TX10 - TX15 - TX20 - TX25 Phillips + Pozi driv + TORX

Schraubendreher Satz
Screwdriver Set



8
tlg./pcs.



Art.-Nr./Art.-No.	Größe/Size
4625	TX8 - TX10 - TX15 - TX20 - TX25 - TX27 - TX30 - TX40 TORX

Schraubendreher Satz mit durchgehender Klinge und Schlagkappe

Go-Through Screwdriver Set with Hammering Cap



6
tlg./pcs.



Art.-Nr./Art.-No.	Größe/Size
5199	PH 1 - 2 / 0,8 x 4,5 - 1,0 x 5,5 - 1,2 x 7,0 - 1,2 x 8,0 mm Phillips + Schlitz

inkl. Schlüsselhilfe
incl. Wrench Adapter



Robuste Schlagkappe
Hammering cap



Schraubendrehersätze

Screwdriver Sets



Art.-Gruppe 140
Article Group 140

Schraubendreher Sätze

Screwdriver Sets

8
tlg./pcs.



4725

Schraubendreher Satz

Screwdriver Set

6
tlg./pcs.



Art.-Nr./Art.-No.	Größe/Size
4721	PH 1 - 2 / PZ 1 - 2 / TX10 - TX15 - TX20 - TX25 Phillips + Pozidriv + TORX®
4722	PH 1 - 2 / PZ 1 - 2 0,8 x 4,0 - 1,0 x 5,5 - 1,2 x 6,5 mm Bit-Magnethalter / Phillips + Pozidriv + Schlitz
4725	PH 1 - 2 / PZ 1 - 2 / TX20 - TX25 / 0,8 x 4,0 - 1,2 x 6,5 mm Phillips + Pozidriv + TORX® + Schlitz

Art.-Nr./Art.-No.	Größe/Size
4727	PH 1 - 2 / 0,5 x 3,0 - 0,8 x 4,0 - 1,0 x 5,5 - 1,2 x 6,5 mm Phillips + Schlitz

Schraubendreher Sätze

Screwdriver Sets

8
tlg./pcs.



4723

Art.-Nr./Art.-No.	Größe/Size
4723	TX8 - TX10 - TX15 - TX20 - TX25 - TX27 - TX30 - TX40 TORX®
4724	TX8 - TX10 - TX15 - TX20 - TX25 - TX27 - TX30 - TX40 TX mit Bohrung/tamper TORX®

Weitere PROForm-Werkstatteinlagen ab Seite /
More PROForm Inlays for Roller Cabinet from Page H 36

Winkelstiftschlüssel und Sätze

Hex Keys and Sets



Art.-Gruppe 141
Article Group 141

Sechskant-Winkelstiftschlüssel matt-satiniert, verchromt kurze Form nach DIN 911
Hex Keys, according to DIN 911, Short Version



Art.-Nr./Art.-No.	Größe/Size	L1	L2	€
3601-1.5	1,5 mm	14	45	
3601-2	2,0 mm	16	50	
3601-2.5	2,5 mm	18	56	
3601-3	3,0 mm	20	63	
3601-4	4,0 mm	25	70	
3601-5	5,0 mm	28	80	
3601-6	6,0 mm	32	90	
3601-7	7,0 mm	34	95	
3601-8	8,0 mm	36	100	
3601-10	10,0 mm	40	112	
3601-12	12,0 mm	45	125	
3601-14	14,0 mm	56	140	
3601-17	17,0 mm	63	160	
3601-19	19,0 mm	70	180	

Sechskant-Kugelpf-Winkelstiftschlüssel, matt-satiniert, verchromt extra lange Form
Ball Point Hex Keys, Extra Long Version

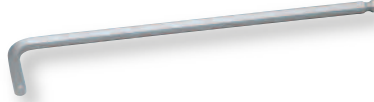

Art.-Nr./Art.-No.	Größe/Size	L1	L2	€
3602-1.5	1,5 mm	14	90	
3602-2	2,0 mm	16	100	
3602-2.5	2,5 mm	18	112	
3602-3	3,0 mm	20	126	
3602-4	4,0 mm	25	140	
3602-5	5,0 mm	28	160	
3602-6	6,0 mm	32	180	
3602-7	7,0 mm	34	190	
3602-8	8,0 mm	36	200	
3602-10	10,0 mm	40	224	
3602-12	12,0 mm	45	250	
3602-14	14,0 mm	56	280	
3602-17	17,0 mm	63	320	

TX-Winkelstiftschlüssel matt-satiniert verchromt, extra lange Form
TX Hex Keys, Extra Long Version



Art.-Nr./Art.-No.	Größe/Size	L1	L2	€
3607-10	T10	14	90	
3607-15	T15	16	100	
3607-20	T20	18	112	
3607-25	T25	20	126	
3607-27	T27	25	140	
3607-30	T30	28	160	
3607-40	T40	32	180	
3607-45	T45	36	200	
3607-50	T50	40	224	

3601

9
tlg./pcs.

Sechskant-Winkelstiftschlüssel Satz 9-teilig im Halter, matt-satiniert verchromt, kurze Form nach DIN 911
Hex Key Set, 9 pieces, Short Version, according to DIN 911

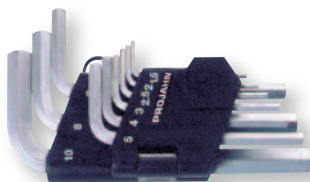

Art.-Nr./Art.-No.	Größe/Size
3601	1,5 - 2 - 2,5 - 3 - 4 - 5 - 6 - 8 - 10 mm

3602

9
tlg./pcs.

Sechskant-Kugelpf-Winkelstiftschlüssel Satz 9-teilig im Halter, matt-satiniert verchromt extra lange Form
Ball Point Hex Key Set, 9 pieces, Extra Long Version



Art.-Nr./Art.-No.	Größe/Size
3602	1,5 - 2 - 2,5 - 3 - 4 - 5 - 6 - 8 - 10 mm

3607

9
tlg./pcs.

TX-Winkelstiftschlüssel Satz 9-teilig im Halter, matt-satiniert verchromt, extra lange Form
TX Hex Key Set, 9 pieces, Extra Long Version

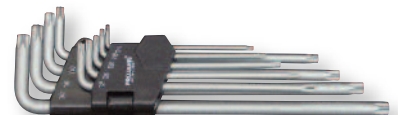

Art.-Nr./Art.-No.	Größe/Size
3607	T10 - 15 - 20 - 25 - 27 - 30 - 40 - 45 - 50

Winkelstiftschlüssel Sätze

Hex Key Sets



Art.-Gruppe 141
Article Group 141

PROFESSIONAL PLUS STANDARD

3619

8
tlg./pcs.

Sechskant-Winkelstiftschlüssel Satz 8-teilig im Klapphalter, matt-satiniert verchromt

Folding Hex Key Set, 8 pieces

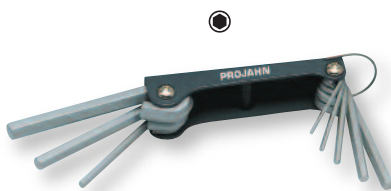

Art.-Nr./Art.-No.	Größe/Size
3619	2,5 - 3 - 4 - 5 - 6 - 7 - 8 - 10 mm

PROFESSIONAL PLUS STANDARD

3613 **NEU/NEW**

9
tlg./pcs.

BLUE EDITION Sechskant-Kugelkopf-Winkelstiftschlüssel Satz 9-teilig im Halter, matt-satiniert verchromt extra lange Form

Ball Point Hex Key Set, 9 pieces, Extra Long Version



- ▶ Kugelkopf mit integriertem Magnet, Schlüssel blau eloxiert
- ▶ Magnetic ball point, blue anodic treatment

Art.-Nr./Art.-No.	Größe/Size
3613	1,5 - 2 - 2,5 - 3 - 4 - 5 - 6 - 8 - 10 mm

PROFESSIONAL PLUS STANDARD

3603

9
tlg./pcs.

Sechskant-Kugelkopf-Winkelstiftschlüssel Satz 9-teilig im Halter, Zoll, matt-satiniert verchromt, extra lange Form

Ball Point Hex Key Set, 9 pieces, Inch, Extra Long Version



Art.-Nr./Art.-No.	Größe/Size
3603	1/16" - 5/64" - 3/32" - 1/8" - 5/32" - 3/16" - 1/4" - 5/16" - 3/8"

PROFESSIONAL PLUS STANDARD

3629

8
tlg./pcs.

Sechskant-Kugelkopf-Winkelstiftschlüssel Satz 8-teilig im Klapphalter, matt-satiniert, verchromt

Folding Ball Point Hex Key Set, 8 pieces



Art.-Nr./Art.-No.	Größe/Size
3629	2,5 - 3 - 4 - 5 - 6 - 7 - 8 - 10 mm

PROFESSIONAL PLUS STANDARD

3604

8
tlg./pcs.

Sechskant-Kugelkopf-Winkelstiftschlüssel Satz 8-teilig im Drehgriff-Halter

Ball Point Hex Key Set, 8 pieces, use the holder as a handle



Art.-Nr./Art.-No.	Größe/Size
3604	2 - 2,5 - 3 - 4 - 5 - 6 - 8 - 10 mm



Zangen

Pliers



Zangen – Innovative Technik für clevere Handwerker

Pliers – Innovative Technique for Clever Craftsmen

Ergonomisch

Ergonomic

- ▶ Hohe Kraftübertragung durch optimale Anpassung des Mehrkomponentengriffs an die Hand
 - ▶ Rutschfeste Oberfläche minimiert das Abrutschen der Hand auch bei öligen oder fettigen Händen
 - ▶ Geringer Kraftaufwand und damit geringere Ermüdung durch ergonomisches und innovatives Design
 - ▶ Innovative Multifunktionszangen vermeiden lästige Werkzeugwechsel und sparen somit Zeit und Kosten
- ▶ High power transmission due to a optimized multi-component handle*
▶ Non-slip surface minimizes slipping also with oily or greasy hands
▶ Minimized efforts and fatigues due to an ergonomic design
▶ Innovative multifunctional pliers avoid frequent change of tools and therefore save time and money

Vielseitig

Versatile

- ▶ Für jeden Anwender die richtige Zange durch breites und innovatives Produktsortiment
 - ▶ Für sicheres Arbeiten an elektrischen Anlagen als VDE-Version erhältlich
 - ▶ Viele Anwendungen mit nur einem Werkzeug durch innovative Multifunktionszangen
 - ▶ Große Produktauswahl an perfekt abgestimmten Sets
- ▶ For every user the right plier due to a wide product range*
▶ As VDE-Versions available – Safety working on electrical installations
▶ Versatile applications with only one tool due to innovative multifunctional pliers
▶ Wide product range of perfect customized sets



Strapazierfähig und langlebig

Hardwearing and Durable

- ▶ Speziell für den professionellen Einsatz durch hochlegierten, Gesenk geschmiedeten und ölgehärteten Chrom-Vanadium-Stahl geeignet
 - ▶ Noch mehr Stabilität und Haltbarkeit durch induktiv gehärtete Präzisionsschneiden
 - ▶ Dauerhaft hohe Qualität durch prozessgesteuerte Fertigung entsprechend DIN- und ISO-Normen
- ▶ Especially for the professional usage due to high alloyed, drop-forged and oil-hardened Chrome-Vanadium-Steel*
▶ Even more durability and hardwearing due to induction hardened precision cutting edges
▶ Permanent high quality due to process-controlled production according DIN- and ISO-Standards

Sicherheit

Safety

- ▶ Höchste Sicherheit bei Arbeiten an elektrischen Anlagen durch Prüfung nach DIN-EN 60900 und IEC 900 (VDE-Ausführung)
 - ▶ Verminderung der Abrutschgefahr der Hand durch optimierte Griffform
 - ▶ Minimierung der Verletzungsgefahr durch in die Griffe eingearbeiteten Aufprallschutz
- ▶ Highest safety during working on electrical installations due to tests according to DIN-EN 60900 and IEC 900 (VDE-Version)*
▶ Optimized handle reduces the risk of slipping
▶ Minimization of the risk of injury due to handles with integrated anti-trap protection

Kombizangen und Seitenschneider

Combination Pliers and Side Cutters

Art.-Gruppe 155
Article Group 155

Kombizangen

Schneiden gehärtet

Combination Pliers

Art.-Nr./Art.-No.	Größe/Size	€
4601-165	165 mm	
4601-180	180 mm	



Profi Winkel-Kombizange 45°

Schneiden gehärtet

Professional Angle Combination Plier 45°

Art.-Nr./Art.-No.	Größe/Size	€
4601-200	180 mm	
4601-20006	Verkaufsdisplay mit 6x 4601-200	



Induktiv gehärtete Schneide für harte und weiche Drähte, integrierter Ringschlüssel 11 – 17 mm / M8 – M10, spezielle Greifzone für Flach- und Rundmaterialien. Ideal für enge Stellen im Boden- und Deckenbereich. Größtmögliche Kraftübertragung, da die Hand in der natürlichen Position gehalten wird – kein Verdrehen des Handgelenkes. Perfekt geeignet für Arbeiten über Kopf

Induction hardened cutting edges for hard and soft wires, integrated ring wrench 11 to 17 mm / M8 to M10, special grip zones for flat and round materials. Best for tight spaces in floor and ceiling area. Maximum power transfer, when hand is in a natural position - no twisting of the hand joint. Perfect for working overhead

Seitenschneider

Schneiden gehärtet

Side Cutter

Induktiv gehärtete Präzisionsschneide, für Piano-Draht (D2-Qualität), enorme Schneidkraft, durch VPA-Remscheid ermittelt: 40 % Kraftersparnis

Precision cutting edges, induction hardened, for piano-wire (D2-quality), enormous cutting force, 40 % reduced effort attested by VPA-Remscheid



Art.-Nr./Art.-No.	Größe/Size	Typ/Model	€
4603-145	145 mm	Seitenschneider	
4603-160	160 mm	Seitenschneider	



Art.-Nr./Art.-No.	Größe/Size	Typ/Model	€
4604-180	180 mm	Hebel Kraft Seitenschneider	



Art.-Nr./Art.-No.	Größe/Size	Typ/Model	€
4602-180	180 mm	Kraft Seitenschneider	

Telefon-, Radio- und Abisolierzangen

Long Nose and Wire Stripping Pliers

Art.-Gruppen 150/155
Article Groups 150/155

Telefon-/Radiozangen

Long Nose Pliers

DIN ISO 5745, induktiv gehärtete Schneide, gezahnte Greifflächen, lange, gerade, flachrunde Backen

DIN ISO 5745, induction hardened cutting edges, serrated inside jaws, long, straight, flatround jaws

Art.-Nr./Art.-No.	Größe/Size	Typ/Model	€
4605-170	170 mm	Telefonzange	
4605-200	205 mm	Telefonzange	
4606-200	205 mm	Telefonzange 45°	

Abisolierzangen

mit Öffnungsfeder und V-förmiger Schneide mit Stellschraube zum Einstellen für Drähte und Litzen bis Ø 5 mm bzw. 10 mm²

Wire Stripping Pliers

Art.-Nr./Art.-No.	Größe/Size	€
4607-160	160 mm	



Weitere PROForm-Werkstatteinlagen ab Seite /
More PROForm Inlays for Roller Cabinet from Page H 36

Wasserpumpenzangen, Armaturen-Zangenschlüssel und Eckrohrzangen

Waterpump Pliers, Plier Wrench for Fittings and Swedish Elbow Pipe Wrenches

Art.-Gruppe 155
Article Group 155

Wasserpumpenzangen

Waterpump Pliers

Art.-Nr./Art.-No.	Größe/Size	€
4609-175	175 mm	
4609-240	240 mm	
4609-300	300 mm	
4609-400	400 mm	



Wasserpumpenzange

Waterpump Pliers

Art.-Nr./Art.-No.	Größe/Size	€
4608-250	250 mm	



Wasserpumpenzangen „MAXI MX“ mit Druckknopf-Einhandverstellung

Waterpump Pliers „MAXI MX“

Art.-Nr./Art.-No.	Größe/Size	€
4516-250	250 mm	
4517-300	300 mm	



Armaturen-Zangenschlüssel mit glattpolierten Greifflächen

Plier wrench for fittings

With smoothly polished gripping surfaces

Art.-Nr./Art.-No.	Größe/Size	Länge/Length	€
4618-250	1"	250 mm	



Schwedische Eckrohrzangen

S-förmiges Maul

Swedish Elbow Pipe Wrench

Art.-Nr./Art.-No.	Größe/Size	Länge/Length	€
4557-340	1"	340 mm	
4557-430	1 1/2"	430 mm	
4557-550	2"	550 mm	



Art.-Nr./Art.-No.	Größe/Size	Winkel	Länge/Length	€
4559-340	1"	90°	340 mm	
4559-430	1 1/2"	90°	430 mm	
4559-550	2"	90°	550 mm	
4559-650	3"	90°	650 mm	



Wasserpumpen-, Eckrohr-, Flechter- und Kantenzangen

Waterpump Plier, Elbow Pipe Wrenches, KX-tower Pincers and Pincers

Art-Gruppe 155
Article Group 155

Wasserpumpen- und Eckrohrzangen Satz, 3-tlg.

Waterpump and Elbow Pipe Wrench Set, 3 pcs.

3
tlg./pcs.

Art.-Nr./Art.-No.	Größe/Size
9985	Wasserpumpenzange/Waterpump Plier 240 mm + Schwedische Eckrohrzange/Elbow Pipe Wrench 1" + Schwedische Eckrohrzange/Elbow Pipe Wrench 1 1/2"



Bestehend aus Artikel 4609-240 + 4557-340 + 4557-430

Content item 4609-240 + 4557-340 + 4557-430

KX-Solinger Flechterzangen

KX-Tower Pincers

Schneiden gehärtet

Hardened Cutting Edges

Art.-Nr./Art.-No.	Größe/Size	€
4640-230	230 mm	
4640-260	260 mm	



Beiß-/Kantenzangen

Pincers

Art.-Nr./Art.-No.	Größe/Size	€
4643-180	180 mm	
4643-210	210 mm	



Weitere PROForm-Werkstatteinlagen ab Seite /
More PROForm Inlays for Roller Cabinet from Page H 36

Zangen VDE/EN 60900

Pliers VDE/EN 60900



Art.-Gruppe 155
Article Group 155

Nach DIN EN 60900, IEC 900, Stückprüfung im Wasserbad mit einer Prüfspannung von 10.000 Volt.
Kälteschlagprüfung bei -40° (Kennzeichnung C)

According to DIN EN 60900, IEC 900. Tested by 10.000 Volt.



Art.-Nr./Art.-No.	Größe/Size	Typ/Model	€
4621-180	180 mm	Kraft Kombizange	



Art.-Nr./Art.-No.	Größe/Size	Typ/Model	€
4629-160	160 mm	Kabelschneider	
4629-210	210 mm	Kabelschneider	



Art.-Nr./Art.-No.	Größe/Size	Typ/Model	€
4623-160	160 mm	Seitenschneider	



Art.-Nr./Art.-No.	Größe/Size	Typ/Model	€
4622-180	180 mm	Kraft Seitenschneider	



Art.-Nr./Art.-No.	Größe/Size	Typ/Model	€
4625-200	205 mm	Telefonzange	



Art.-Nr./Art.-No.	Größe/Size	Typ/Model	€
4626-200	205 mm	Telefonzange 45°	

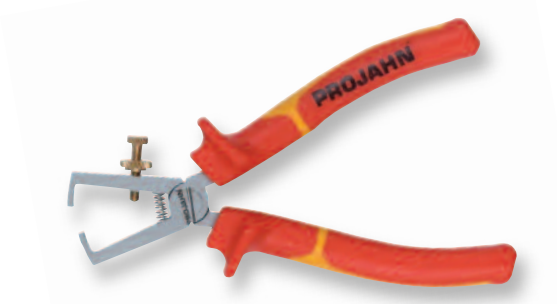

Art.-Nr./Art.-No.	Größe/Size	Typ/Model	€
4627-160	160 mm	Abisolierzange	



Art.-Nr./Art.-No.	Größe/Size	Typ/Model	€
4628-250	250 mm	Wasserpumpenzange	

Multifunktionszangen VDE/EN 60900

Functional Pliers VDE/EN 60900



Art-Gruppe 155
Article Group 155

**Nach DIN EN 60900, IEC 900, Stückprüfung im Wasserbad mit einer Prüfspannung von 10.000 Volt.
Kälteschlagprüfung bei -40° (Kennzeichnung C)**

According to DIN EN 60900, IEC 900. Tested by 10.000 Volt.

Profi Winkel-Kombizange 45°

Schneiden gehärtet

Professional Angle Combination Plier 45°

Art.-Nr./Art.-No.	Größe/Size	€
4621-200	180 mm	
4621-20006	Verkaufsdiskret mit 6x 4621-200	

Technische Details entnehmen Sie bitte der Seite H 211 (4601-200)
Please find technical information on page H 211 (4601-200).



Multischneider 3-in-1

Multicutter 3-in-1

3 Funktionen mit einem Werkzeug

Abschneiden, Abmanteln, Abisolieren

One Tool – 3 Functions

Cut Off, Strip Cable, Strip Wire

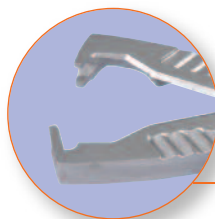

Art.-Nr./Art.-No.	Größe/Size	Typ/Model	€
4630-180	180 mm	Multischneider 3-in-1	



ERGO Multifunktions-Elektrozange 45°

ERGO Multifunctional Electrician's Pliers

Schonendes und ermüdungsarmes Arbeiten durch ergonomisches Zangendesign

Vereint viele Funktionen in einem Werkzeug

Strain-Free Working due to ergonomic design

Combines many different functions in one tool

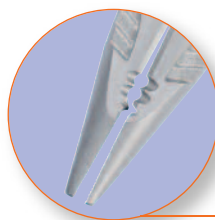

Art.-Nr./Art.-No.	Größe/Size	Typ/Model	€
4631-200	200 mm	ERGO Multifunktions-Elektrozange 45°	



Sicherungsringzangen

Circlip Pliers

Art.-Gruppen 150/155
Article Groups 150/155

PROFESSIONAL PLUS STANDARD

Sicherungsringzangen

Circlip Pliers



Art.-Nr./Art.-No.	Größe/Size		€
4683-A2	A2	19 - 60 mm	für Außenringe, gerade
4683-A21	A21	19 - 60 mm	für Außenringe, gebogen
4683-J2	J2	19 - 60 mm	für Innenringe, gerade
4683-J21	J21	19 - 60 mm	für Innenringe, gebogen

PROFESSIONAL PLUS STANDARD

Sicherungsringzangen

Circlip Pliers



Art.-Nr./Art.-No.	Größe/Size		€
4383-A1	A1	10 - 25 mm	für Außenringe, gerade
4383-A11	A11	10 - 25 mm	für Außenringe, gebogen
4383-A2	A2	19 - 60 mm	für Außenringe, gerade
4383-A21	A21	19 - 60 mm	für Außenringe, gebogen
4383-A3	A3	40 - 100 mm	für Außenringe, gerade
4383-A31	A31	40 - 100 mm	für Außenringe, gebogen
4383-J1	J1	12 - 25 mm	für Innenringe, gerade
4383-J11	J11	12 - 25 mm	für Innenringe, gebogen
4383-J2	J2	19 - 60 mm	für Innenringe, gerade
4383-J21	J21	19 - 60 mm	für Innenringe, gebogen
4383-J3	J3	40 - 100 mm	für Innenringe, gerade
4383-J31	J31	40 - 100 mm	für Innenringe, gebogen

Blech-/Figurenscheren, Mattenschneider, Bolzenschneider

Tinmans Shears, Mesh Cutter, Bolt Cutter

Art.-Gruppen 150/155
Article Groups 150/155

PROFESSIONAL PLUS STANDARD

Blech-/Figurenscheren

Schnittleistung: Stahlblech bis 1,2 mm

Tinmans Shears

Cutting Capacity: Sheet Steel 1,2 mm

Art.-Nr./Art.-No.	€
4584	Satz 3-tlg./pcs links/rechts/gerade
4550	rot/links
4551	grün/rechts
4552	gelb/gerade



PROFESSIONAL PLUS STANDARD

Mattenschneider

Mesh Cutter

Spezial Mattenschneider

zum Schneiden von Baustahlgeweben

Mesh Cutter



Art.-Nr./Art.-No.	L/L	max. Schneid-Ø bei 750 N/mm ²	max. Schneid-Ø bei 1250 N/mm ²	€
4555	900 mm	12 mm	10 mm	

PROFESSIONAL PLUS STANDARD

Bolzenschneider

Bolt Cutter

Bolzenschneider

Verschraubte, auswechselbare Köpfe

geschmiedete Backen aus Chrom-Molybdän-Stahl

Bolt Cutter



Art.-Nr./Art.-No.	Größe/Size	L/L	Weich Mat. max/Soft Mat. Max	Hart Mat. max/Hart Mat. Max	€
4553-14	14"	350 mm	6 mm	5 mm	
4553-18	18"	450 mm	7 mm	6 mm	
4553-24	24"	600 mm	10 mm	8 mm	
4553-30	30"	750 mm	13 mm	10 mm	
4553-36	36"	900 mm	16 mm	12 mm	
4554-14	14"	Ersatz-Schneidkopf			
4554-18	18"	Ersatz-Schneidkopf			
4554-24	24"	Ersatz-Schneidkopf			
4554-30	30"	Ersatz-Schneidkopf			
4554-36	36"	Ersatz-Schneidkopf			

Gripzangen

Self Grip Pliers

Art.-Gruppe 150
Article Group 150

PROFESSIONAL PLUS STANDARD

Gripzangen

glanzvernickelt, mit Lösehebel und gebogenen Backen

Self Grip Pliers

Art.-Nr./Art.-No.	Größe/Size	L/L	Spannweite/Capacity	€
4556-175	7"	175 mm	41 mm	
4556-250	10"	250 mm	48 mm	



PROFESSIONAL PLUS STANDARD

Breitmaul-Gripzangen

Self Grip Plier With Wide Jaws

Besonders breite und flache Greifbacken mit Lösehebel, geeignet zum Halten, Biegen und Bördeln von Blechen

Special width and flat self grip pliers with quick release lever, useful for fixing, bending and beading of sheets and plates

Art.-Nr./Art.-No.	Größe/Size	L/L	Spannweite/Capacity	€
4561-205	8"	205 mm	60 mm	
4561-245	10"	245 mm	67 mm	



PROFESSIONAL PLUS STANDARD

Schweißer-Gripzange

Welding Self Grip Plier



U-Form-Greifbacken, obere Greifbacke 90° abgewinkelt, zum Spannen beim Verschweißen von Profil- oder Flachmaterial, usw. auf Stoß

U-form-grip, top grip 90° offset, for clamping the welding of profile or flat material, etc. on strike

Art.-Nr./Art.-No.	Größe/Size	L/L	Spannweite/Capacity	€
4562-225	9"	0 – 45 mm	45 mm	

PROFESSIONAL PLUS STANDARD

Klammer-Gripzange

Welding-Clip Self Grip Plier



Schmale Greifbacken mit hohem Bügel, tief ausladend, geeignet zum Spannen von Profil-Material mit hohen Stegen oder über sperrige Werkstücke

Narrow gripping jaws with high temple, deep overhangs, suitable for clamping profile material with high piers or bulky workpieces

Art.-Nr./Art.-No.	Größe/Size	L/L	Spannweite/Capacity	€
4563-275	11"	280 mm	73 mm	

Langbeck Klemmzangen, Elektronik Zangen

Self Grip Pliers, Electronic Pliers

Art.-Gruppe 150
Article Group 150

Langbeck Klemmzange

glanzvernickelt, mit Lösehebel und geraden, langen Backen

Self Grip Pliers, Long Jaws

Art.-Nr./Art.-No.	Größe/Size	L/L	Spannweite/Capacity	€
4557-150	6"	150 mm	44,5 mm	



Elektronik Zangen

Electronic Pliers

Elektronik Zangen

Spezial-Serie für extrem feines Arbeiten auf engstem Raum und an schwer zugänglichen Stellen.

Electronic Pliers

Special line for extremely precise working in smallest spaces and in positions otherwise inaccessible.



Art.-Nr./Art.-No.	Größe/Size	Typ/Model	€
4330-130	130 mm	Flachzange	



Art.-Nr./Art.-No.	Größe/Size	Typ/Model	€
4331-120	130 mm	Rundzange	



Art.-Nr./Art.-No.	Größe/Size	Typ/Model	€
4332-130	130 mm	Kettenzange	



Art.-Nr./Art.-No.	Größe/Size	Typ/Model	€
4333-120	130 mm	Kettenzange 45°	



Art.-Nr./Art.-No.	Größe/Size	Typ/Model	€
4334-110	110 mm	Seitenschneider	

Zangen-Sätze

Pliers Sets

Art.-Gruppe 155
Article Group 155

4680

Zangen Set 3-teilig

- **Kombizange 180 mm**
- **Seitenschneider 160 mm**
- **Wasserpumpenzange 250 mm**

- Pliers Set 3 pieces*
- *Combination pliers 180 mm*
 - *Side Cutter 160 mm*
 - *Waterpump Pliers 250 mm*

Art.-Nr./Art.-No. €
4680 3-tlg./pcs

3
tlg./pcs.



4681

Zangen Set 3-teilig

- **Kombizange 180 mm**
- **Seitenschneider 160 mm**
- **Telefonzange 205 mm**

- Pliers Set 3 pieces*
- *Combination pliers 180 mm*
 - *Side cutter 160 mm*
 - *Long nose plier 205 mm*

Art.-Nr./Art.-No. €
4681 3-tlg./pcs

3
tlg./pcs.



Zangen Set VDE 3-teilig

Pliers Set VDE 3 pieces



4691

Zangen Set VDE 3-teilig VDE/EN 60900

- **Kombizange 180 mm**
- **Seitenschneider 160 mm**
- **Telefonzange 205 mm**

- Pliers Set VDE 3 pieces
VDE/EN 60900*
- *Combination pliers 180 mm*
 - *Side Cutter 160 mm*
 - *Long nose pliers 205 mm*

Art.-Nr./Art.-No. €
4691 3-tlg./pcs

3
tlg./pcs.



Zangen-Sätze

Pliers Sets

Art.-Gruppen 150/155
Article Groups 150/155

PROFESSIONAL PLUS STANDARD

4683

Sicherungsringzangen Satz, 4-teilig

Circlip Pliers Set, 4 pieces

4
tlg./pcs.

Art.-Nr./Art.-No.

€

4683

A2 - A21 - J2 - J21

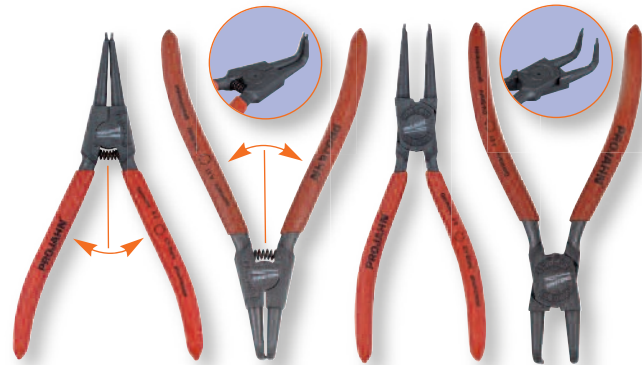

PROFESSIONAL PLUS STANDARD

4383

Sicherungsringzangen Satz, 4-teilig

Circlip Pliers Set, 4 pieces

4
tlg./pcs.

Art.-Nr./Art.-No.

€

4383

A2 - A21 - J2 - J21



PROFESSIONAL PLUS STANDARD

Blech-/Figurenscheren Satz, 3-teilig

Tinmans Shears Set, 3 pieces

4584

Blech-/Figurenscheren Satz 3-teilig

Schnittleistung: Stahlblech bis 1,2 mm

Tinmans shears set 3 pieces

Cutting capacity: sheet steel 1,2 mm

3
tlg./pcs.

Art.-Nr./Art.-No.

€

4584

Satz 3-tlg./pcs links/rechts/gerade



NEU/NEW

Taschenlampen & Arbeitsleuchten

Flashlights & Working Lamps



Power-LED-Taschenlampen & Arbeitsleuchten

Power LED Flashlights and Working Lamps

NEU/NEW

PROLUMAX



398211

- ▶ **Neueste LED-Technologie**
 - Hohe Lichtleistung + Helligkeit, große Leuchtweite, nahezu weißes Licht
 - Lange LED-Lebensdauer
 - 10 Jahre Funktionsgarantie auf alle PROLumax-Leuchten mit Cree®, SMD®- und COB®-LED-Technologie
- ▶ **Hochwertige Verarbeitung & Materialien**
 - Aus robustem, langlebigem und stoßfestem Flugzeugaluminium
 - Spritzwasserdicht nach IP54
- ▶ **Schlankes und modernes Design verknüpft mit durchdachten Mehrwerten**
 - Kein unnötiger Ballast und ausgeglichenes Handling
 - Sowohl mit handelsüblichen Batterien als auch mit Standardakkus funktionsfähig
 - Wiederaufladbare Lithium-Ionen-Akkus (bei Modellen 398250, 398251)
 - Ergonomische, rutschhemmende Oberfläche
- ▶ **Innovative Funktionen**
 - Mit Handschuh bedienbarer Schalter, zusätzlich Wegrollschutz
 - 2 Lichtleistungen über Schalter wählbar bzw. stufenlos dimmbar (nicht bei Art.-Nr. 398210 / 398213 / 398214)
 - Variabler Leuchtwinkel durch fokussierbare Linse (nicht bei Art.-Nr. 398213 / 398214 / 398215)

- ▶ *Latest LED technology*
 - High luminous power + brightness, extensive light distance, almost white light
 - Long life LED
 - 10 year life guarantee on all PROLumax-flashlights with Cree®, SMD®- and COB®-LED-technology
- ▶ *High-quality workmanship & materials*
 - Made of sturdy, durable and impact-resistant aircraft aluminium
 - Impermeable to splash-water by IP54
- ▶ *Slim and modern design associated with sophisticated added values*
 - No dead weight and easy handling
 - Usable with standard batteries as well as with rechargeable batteries
 - Rechargeable Lithium-Ion batteries (398250, 398251)
 - Ergonomic, non slip surface
- ▶ *Innovative Features*
 - Easily operable with gloves
 - 2 light power levels selectable or continuously dimmable (not for Art.-No. 398210 / 398213 / 398214)
 - Roll away protection
 - Variable angle of illumination by focusable lens (not for Art.-No. 398213 / 398214 / 398215)

* Alle Werte gemessen entsprechend ANSI FL1-Prüfverfahren
* All data scaled according to ANSI FL1-method of test

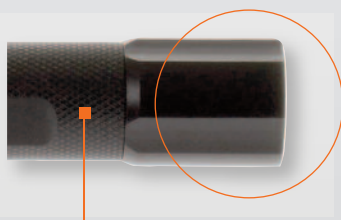

Extrem griffsicher durch rutschfeste Rändelung /
Extremely secure grip due to non-slip knurling

Einkerbungen verhindern Wegrollen /
Roll away protection



Aus Flugzeugaluminium – stoßfest aus 1,5 m Höhe /
Made of aircraft aluminium – durable + impact resistant



Variabler Leuchtwinkel durch fokussierbare Linse /
Variable angle of illumination by focusable lens

Zwei Lichtleistungen wählbar / Two Light Power Levels selectable



Ein/Aus-Knopf /
On/Off Switch

Kein ungewolltes Ein/Ausschalten, durch tiefliegenden Ein/Aus-Knopf. Selbst mit Handschuhen bedienbar! / Backside switch, easily operable even with gloves!

Power-LED-Taschenlampen & Arbeitsleuchten

Power LED Flashlights and Working Lamps

NEU/NEW

Art.-Gruppen 184
Article Groups 184

398215

PROFESSIONAL PLUS STANDARD

PROLumax Cree®-Power LED-Taschenlampe PJ 500

PROLumax Cree® Power LED Flashlight PJ 500



stufenlos dimmbar /
continuously dimmable

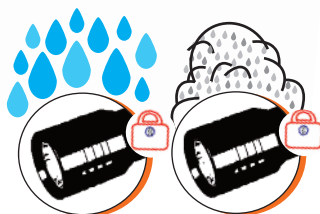

Cree®-Power LED-Taschenlampe PJ 500

NEU/NEW

Technische Daten / Technical Details:

Leuchtmittel/Illuminant:	10 Watt CREE® CM-L2 T6 Power-LED
Leuchtdauer/Fluorescent time:	ca. 8 Stunden/hours*
Lichtleistung/Light Power:	500 Lumen*
Leuchtweite/Light Distance:	300 Meter*
Material/Material:	Aluminium, eloxiert
Gewicht/Weight:	225 Gramm
Batterien/Batteries:	3x C-Cell (inklusive)

- ▶ 10 Jahre Funktionsgarantie auf LED/
10 year functional guarantee on LED
- ▶ IP 67 = wasser- und staubdicht,
über Ein-/Ausschalter stufenlos dimmbar/
IP 67 = water and dust proof,
continuously dimmable

Art.-Nr./Art.-No.	Modell/Model	Farbe/Color	Länge/Length	Ø	€
398215	PJ500	Schwarz/Black	236 mm	42 mm	

398211

PROFESSIONAL PLUS STANDARD

PROLumax Cree®-Power LED-Taschenlampe PJ 120

PROLumax Cree® Power LED Flashlight PJ 120



Cree®-Power LED-Stiftlampe PJ 120

NEU/NEW

Technische Daten / Technical Details:

Leuchtmittel/Illuminant:	3 Watt CREE® white XP-E LED
Leuchtdauer/Fluorescent time:	ca. 2,5 Stunden/hours*
Lichtleistung/Light Power:	120 Lumen*
Leuchtweite/Light Distance:	65 Meter*
Material/Material:	Aluminium, eloxiert
Gewicht/Weight:	85 Gramm
Batterien/Batteries:	2x AA (inklusive)

- ▶ 10 Jahre Funktionsgarantie auf LED/
10 year functional guarantee on LED
- ▶ Fokussierbare Linse, zwei Lichtleistungen/
Focusable lens, two light power levels

Art.-Nr./Art.-No.	Modell/Model	Farbe/Color	Länge/Length	Ø	€
398211	PJ120	Schwarz/Black	151 mm	29 mm	

Power-LED-Taschenlampen & Arbeitsleuchten

Power LED Flashlights and Working Lamps

NEU/NEW

Art.-Gruppen 184
Article Groups 184

398212

PROFESSIONAL PLUS STANDARD

PROLumax Cree®-Power LED-Taschenlampe PJ 220

PROLumax Cree® Power LED Flashlight PJ 220



Cree®-Power LED-Stiftlampe PJ 220

NEU/NEW

Technische Daten / Technical Details:

Leuchtmittel/Illuminant:	5 Watt Cree® XP-G R5 Power-LED
Leuchtdauer/Fluorescent time:	ca. 1,5 Stunden/hours*
Lichtleistung/Light Power:	220 Lumen*
Leuchtweite/Light Distance:	130 Meter*
Material/Material:	Aluminium, eloxiert
Gewicht/Weight:	171 Gramm
Batterien/Batteries:	3x AAA (inklusive)

- ▶ 10 Jahre Funktionsgarantie auf LED/
10 year functional guarantee on LED
- ▶ Fokussierbare Linse, zwei Lichtleistungen/
Focusable lens, two light power levels

Art.-Nr./Art.-No.	Modell/Model	Farbe/Color	Länge/Length	Ø	€
398212	PJ220	Schwarz/Black	138 mm	41 mm	

398210

PROFESSIONAL PLUS STANDARD

PROLumax Cree®-Power-LED-Taschenlampe PJ 45

PROLumax Cree® Power LED Flashlight PJ 45



Cree®-Power LED-Taschenlampe PJ 45

NEU/NEW

Technische Daten / Technical Details:

Leuchtmittel/Illuminant:	3 Watt Cree® white XPE LED
Leuchtdauer/Fluorescent time:	ca. 6 Stunden/hours*
Lichtleistung/Light Power:	45 Lumen*
Leuchtweite/Light Distance:	45 Meter*
Material/Material:	Aluminium, eloxiert
Gewicht/Weight:	51 Gramm
Batterien/Batteries:	1x AA (inklusive)

- ▶ 10 Jahre Funktionsgarantie auf LED/
10 year functional guarantee on LED
- ▶ Fokussierbare Linse, leicht und handlich/
Focusable lens, light weight and handy size

Art.-Nr./Art.-No.	Modell/Model	Farbe/Color	Länge/Length	Ø	€
398210	PJ45	Schwarz/Black	99 mm	25 mm	

* Alle Werte gemessen entsprechend ANSI FL1-Prüfverfahren/All data scaled according to ANSI FL1-method of test

Power-LED-Taschenlampen & Arbeitsleuchten

Power LED Flashlights and Working Lamps

NEU/NEW

Art.-Gruppen 182
Article Groups 182

398213GB

PROFESSIONAL PLUS STANDARD

PROLumax Power-LED-Stiftlampe PJ 15

PROLumax Power LED Penlight PJ 15



Power-LED-Stiftlampe PJ 15

Technische Daten / Technical Details:

Leuchtmittel/Illuminant:	0,5 Watt Power-LED
Leuchtdauer/Fluorescent time:	ca. 4 Stunden/hours*
Lichtleistung/Light Power:	15 Lumen*
Leuchtweite/Light Distance:	13 Meter*
Material/Material:	Aluminium, eloxiert
Gewicht/Weight:	31 Gramm
Batterien/Batteries:	1x AAA (inklusive)

- ▶ Mit Karabinerhaken ideal für den Schlüsselbund/
With carabiner fits perfect to your bunch of keys

NEU/NEW



Art.-Nr./Art.-No.	Modell/Model	Farbe/Color	Länge/Length	Ø	€
398213GB	PJ15	Schwarz/Black	95 mm	17 mm	
39821314D	Display mit 9 x 398213 und 9 x 398214				

398214GB

PROFESSIONAL PLUS STANDARD

PROLumax Power-LED-Stiftlampe PJ 23

PROLumax Power LED Penlight PJ 23



Power-LED-Stiftlampe PJ 23

Technische Daten / Technical Details:

Leuchtmittel/Illuminant:	0,5 Watt Power-LED
Leuchtdauer/Fluorescent time:	ca. 4 Stunden/hours*
Lichtleistung/Light Power:	23 Lumen*
Leuchtweite/Light Distance:	16 Meter*
Material/Material:	Aluminium, eloxiert
Gewicht/Weight:	36 Gramm
Batterien/Batteries:	2x AAA (inklusive)

- ▶ Mit Halteclip ideal für Jacken- oder Westentasche/
With clip perfect for your waist coat pocket

NEU/NEW



Art.-Nr./Art.-No.	Modell/Model	Farbe/Color	Länge/Length	Ø	€
398214GB	PJ23	Schwarz/Black	139 mm	17 mm	
39821314D	Display mit 9 x 398214 und 9 x 398213				

398230

PROFESSIONAL PLUS STANDARD

PROLumax Cree®-Power LED-Stirnlampe PJ 100 S

PROLumax Cree® Power LED Headlamp PJ 100 S



Ein/Aus-Knopf /
On/Off Switch



Cree®-Power LED-Stirnlampe PJ 100 S

Technische Daten / Technical Details:

Leuchtmittel/Illuminant:	1x 3 Watt CREE® XP-E LED 1x Standard-LED (weiß) 2x Standard-LED (rot)
Leuchtdauer/Fluorescent time:	ca. 6 Stunden/hours*
Lichtleistung/Light Power:	100 Lumen*
Leuchtweite/Light Distance:	50 Meter*
Material/Material:	Kunststoff/plastic
Gewicht/Weight:	140 Gramm
Batterien/Batteries:	3x AAA (inklusive)

- ▶ 10 Jahre Funktionsgarantie auf LED/
10 year functional guarantee on LED
- ▶ Hoher Tragekomfort,
2 Lichtleistungen und 3 Leucht-/Blinkmodi einstellbar/
Greater wearing comfort,
2 light power levels and 3 light/twinking levels selectable

NEU/NEW

Art.-Nr./Art.-No.	Modell/Model	Farbe/Color	€
398230	PJ100S	Schwarz/Black	

Power-LED-Taschenlampen & Arbeitsleuchten

Power LED Flashlights and Working Lamps

NEU/NEW

Art.-Gruppen 184
Article Groups 184

398250

PROFESSIONAL PLUS STANDARD

NEU/NEW

PROLumax LED-Hand-Arbeitslampe PJ-AL 120

PROLumax LED Hand Working Lamp PJ-AL 120



Power-LED-Hand-Arbeitslampe PJ-AL 120

Technische Daten / Technical Details:

Leuchtmittel/Illuminant:	4x 0,5 Watt SMD-Power-LED
Leuchtdauer/Fluorescent time:	ca. 3 Stunden/hours*
Lichtleistung/Light Power:	120 Lumen*
Leuchtwinkel/Light Angle:	100°
Ladedauer/Charging Period:	ca. 4 Stunden/hours
Material/Material:	Kunststoff/plastic
Gewicht/Weight:	150 Gramm
Akku/Battery:	Lithium-Ionen-Akku, wiederaufladbar/ rechargeable lithium ions battery
Kapazität/Capacity:	1.800 mAh
Inkl. 110 - 240 V Netzteil und Kfz-Ladekabel/ Incl. 110 - 240 V Power Unit and Car Charger	

- ▶ 10 Jahre Funktionsgarantie auf LED/
10 year functional guarantee on LED
- ▶ Als Powerbank nutzbar, integrierter Kippfuß mit Magnet/
Usable as Powerbank, integrated tilt foot with magnet
- ▶ Wiederaufladbarer Lithium-Ionen-Akku/
Rechargeable lithium ions battery
- ▶ Rutschfeste, ergonomische Oberfläche/
Non-slip surface

Art.-Nr./Art.-No.	Modell/Model	Farbe/Color	Maße/Dimensions	€
398250	PJ-AL 120	Schwarz/Black	60 x 25 x 120 mm	

*Praxisbeispiel. Mobiltelefon nicht im Lieferumfang enthalten.

398251

PROFESSIONAL PLUS STANDARD

NEU/NEW

PROLumax LED-Arbeitslampe PJ-AL 150

PROLumax LED Working Lamp PJ-AL 150



Power-LED-Arbeitslampe PJ-AL 150

Technische Daten / Technical Details:

Leuchtmittel/Illuminant:	1x 1,5 Watt COB-Power-LED
Leuchtdauer/Fluorescent time:	ca. 5 Stunden/hours*
Ladedauer/Charging Period:	ca. 4 Stunden/hours
Material/Material:	Kunststoff/plastic
Gewicht/Weight:	165 Gramm
Lichtleistung/Light Power:	150 Lumen*
Leuchtwinkel/Light Angle:	120°
Akku/Battery:	Lithium-Ionen-Akku, wieder aufladbar/ rechargeable lithium ions battery
Kapazität/Capacity:	1.800 mAh
Inkl. 110 - 240 V Netzteil und Kfz-Ladekabel/ Incl. 110 - 240 V Power Unit and Car Charger	

- ▶ 10 Jahre Funktionsgarantie auf LED/
10 year functional guarantee on LED
- ▶ Extrem schlanke Bauform, rückseitiger Magnet/
Extremely slim design, back side with magnetic area
- ▶ Wiederaufladbarer Lithium-Ionen-Akku/
Rechargeable lithium ions battery
- ▶ Rutschfeste Oberfläche/
Non-slip surface

Art.-Nr./Art.-No.	Modell/Model	Farbe/Color	Maße/Dimensions	€
398251	PJ-AL 150	Schwarz/Black	13 x 45 x 320 mm	

Sonstige Werkzeuge

Other Tools



Hämmer und Stemmeisen

Hammer and Wood Chisel Sets

Art.-Gruppen 160/182
Article Groups 160/182

PROFESSIONAL PLUS STANDARD

Schlosserhämmer mit Stielschutz
Machinist Hammer with Protection



Art.-Nr./Art.-No.	Größe/Size	€
2363	300 g	
2365	500 g	
2368	800 g	
2369	1.000 g	

PROFESSIONAL PLUS STANDARD

Schlosserhämmer
Machinist Hammer



Art.-Nr./Art.-No.	Größe/Size	€
2301	100 g	
2302	200 g	
2303	300 g	
2304	400 g	
2305	500 g	
2308	800 g	
2310	1.000 g	
2315	1.500 g	

PROFESSIONAL PLUS STANDARD

Latthammer
Roofing Hammer



Art.-Nr./Art.-No.	Größe/Size	€
2321	600 g	

▶ **Mit Nagelmagnet zum Halten der Nägel**
▶ With magnet for nails

PROFESSIONAL PLUS STANDARD

Handfäustel
Stoning Hammer



Art.-Nr./Art.-No.	Größe/Size	€
2325	1.000 g	
2324	1.250 g	
2326	1.500 g	

PROFESSIONAL PLUS STANDARD

Kunststoffhammer
Dead-Blow Hammer



Art.-Nr./Art.-No.	Größe/Size	€
2341	Ø 35 mm	
2341-1	Ersatzkopf schwarz/ Hammer Head black	
2341-2	Ersatzkopf gelb/ Hammer Head yellow	

PROFESSIONAL PLUS STANDARD

Stemmeisen Sätze
Wood Chisel Sets



Art.-Nr./Art.-No.	Größe/Size
3361	12 - 16 - 20 - 24 mm, 4-tlg.
3362	6 - 10 - 14 - 18 - 22 - 26 mm, 6-tlg.

Splintentreiber, Durchschläge und Meißel

Pin Punches, Taper Punches and Chisels

Art.-Gruppe 160
Article Group 160

PROFESSIONAL PLUS STANDARD

Splintentreiber-, Durchschlag- und Meißelsätze

Pin Punches, Taper Punches and Chisels

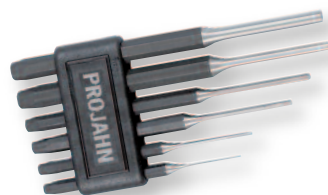

Art.-Nr./Art.-No.	Teile/pieces	Größe/Size	€
3350	6	2-3-4-5-6-8 mm	Splintentreiber/Pin Punch
3355	5	2-3-4-5-6 mm	Durchschlag/Taper Punch
3370	5	Splintentreiber 4 mm, Durchschlag 3 mm, Körner Nr. 2, Kreuzmeißel 5 x 130 mm, 8-kant Flachmeißel 12 x 130 mm	

PROFESSIONAL PLUS STANDARD

Einzelteile

Single Parts



Art.-Nr./Art.-No.	Größe/Size	Länge/Length	€
3350-2	2 mm	115 mm	Splintentreiber/Pin Punch
3350-3	3 mm	125 mm	Splintentreiber/Pin Punch
3350-4	4 mm	150 mm	Splintentreiber/Pin Punch
3350-5	5 mm	165 mm	Splintentreiber/Pin Punch
3350-6	6 mm	180 mm	Splintentreiber/Pin Punch
3350-8	8 mm	180 mm	Splintentreiber/Pin Punch
3355-2	2 mm	120 mm	Durchschlag/Taper Punch
3355-3	3 mm	120 mm	Durchschlag/Taper Punch
3355-4	4 mm	120 mm	Durchschlag/Taper Punch
3355-5	5 mm	120 mm	Durchschlag/Taper Punch
3355-6	6 mm	120 mm	Durchschlag/Taper Punch
3370-1	Nr. 2	120 mm	Körner/Center Punch
3370-2	5 mm	130 mm	Kreuzmeißel/Cross Chisel
3370-3	12 mm	130 mm	8-kant Flachmeißel/Flat Chisel, 8-flank

PROFESSIONAL PLUS STANDARD



Art.-Nr./Art.-No.	Größe/Size	Länge/Length	€
3371-1	16 mm	200 mm	8-kant Spitzmeißel/Pointed Chisel, 8-flank
3371-2	16 mm	200 mm	8-kant Flachmeißel/Flat Chisel, 8-flank

Sanitärwerkzeuge

Sanitary Tools

Art.-Gruppe 190
Article Group 190

Rohrabschneider Mini

Mini Tube Cutter



Rohrabschneider KOMPAKT Mini

Mini Tube Cutter KOMPAKT



Rohrabschneider

Tube Cutter



► Zum Schneiden von Aluminium, Kupfer und dünnwandigen Stahlrohren

► For cutting aluminum, copper, and thin-walled steel tubes

Art.-Nr./Art.-No.	Größe/Size	€
6202	3 – 25 mm	
6299-01	Ersatzrädchen 19 x 5 für AL, Cu, INOX	
6299-07	Ersatzrädchen 22 x 5 für Plastik	

Art.-Nr./Art.-No.	Größe/Size	€
6211	3 – 30 mm	
6299-01	Ersatzrädchen 19 x 5 für AL, Cu, INOX	
6299-07	Ersatzrädchen 22 x 5 für Plastik	

Art.-Nr./Art.-No.	Größe/Size	€
396205	3 – 35 mm	
6299-01	Ersatzrädchen 19 x 5 für AL, Cu, INOX	
6299-07	Ersatzrädchen 22 x 5 für Plastik	

Rohrabschneider mit Entgrater

Telescopic Tube Cutter with Deburrer



Rohrabschneider KOMPAKT mit Entgrater

Telescopic Tube Cutter KOMPAKT with Deburrer



Rohrabschneider KOMPAKT QUICK mit Entgrater

Telescopic Tube Cutter KOMPAKT QUICK with Deburrer



► Zum Schneiden von Aluminium, Kupfer und dünnwandigen Stahlrohren, inkl. 1 Ersatzrädchen im Drehknopf, mit 4 Führungsrollen für einen optimalen Halt des Rohres beim Schneiden, Schneidrädchen-Wechsel ohne Werkzeug

► Artikel 6212 + 6213 mit integrierter NOGA-Entgraterklinge ► Artikel 6214 mit Schnellvorschub

► For cutting aluminum, copper, and thin-walled steel tubes, incl. 1 cutting wheel in rotary handle, with 4 rollers for optimum support of the pipe during cutting, cutting wheel changing without tools

► Article 6212 + 6213 with integrated NOGA deburring blade ► Article 6214 with fast feed

Art.-Nr./Art.-No.	Größe/Size	€
6212	3 – 35 mm	
6299-01	Ersatzrädchen 19 x 5 für AL, Cu, INOX	
6299-07	Ersatzrädchen 22 x 5 für Plastik	

Art.-Nr./Art.-No.	Größe/Size	€
396213	3 – 45 mm	
6299-01	Ersatzrädchen 19 x 5 für AL, Cu, INOX	
6299-07	Ersatzrädchen 22 x 5 für Plastik	

Art.-Nr./Art.-No.	Größe/Size	€
6214	6 – 67 mm	
6299-05	Ersatzrädchen 19 x 6,2 für AL, Cu, INOX	

Sanitärwerkzeuge

Sanitary Tools

Art.-Gruppe 190
Article Group 190

Rohrabschneider KOMPAKT PT QUICK

Tube Cutter KOMPAKT PT QUICK



- ▶ Zum Schneiden von Kunststoff und Verbundrohren, inkl. 1 Ersatzrädchen im Drehknopf mit 4 Führungsrollen für einen optimalen Halt des Rohres beim Schneiden, Schneidrädchen-Wechsel ohne Werkzeug
- ▶ For cutting plastic tubes, incl. 1 cutting wheel in rotary handle, with 4 rollers for optimum support of the pipe during cutting, cutting wheel changing without tools

Art.-Nr./Art.-No.	Größe/Size	€
6215	6 – 67 mm	
6299-06	Ersatzrädchen 26 x 6,2 für Kunststoff- und Verbundrohre	

Rohrabschneider für Stahlrohre

Tube Cutter for Steel Tubes



- ▶ Zum Schneiden von Stahl- und INOX-Rohren – das Federdruck-System garantiert verbesserten Schnitt und längere Lebensdauer des Schneidrädchens
- ▶ For cutting steel- and INOX tubes – a special system ensures improved cutting and longer life of the cutting wheel

Art.-Nr./Art.-No.	Größe/Size	€
6216	10 – 60 mm (1/8" – 2")	
6299-02	Ersatzrädchen 31 x 19 für Stahl und INOX	

Rohrabschneider INOX Mini

Mini Tube Cutter INOX



Rohrabschneider INOX KOMPAKT mit Entgrater

Tube Cutter INOX KOMPAKT with Deburrer



Rohrabschneider INOX KOMPAKT mit Entgrater

Tube Cutter INOX KOMPAKT with Deburrer



- ▶ Zum Schneiden von Aluminium, Kupfer und dünnwandigen Stahlrohren (speziell für V2A-/INOX-Rohre geeignet), inkl. 1 Ersatzrädchen im Drehknopf, Schneidrädchen-Wechsel ohne Werkzeug, Artikel 6222 + 6223 mit 4 Führungsrollen für einen optimalen Halt des Rohres beim Schneiden und integrierter NOGA-Entgraterklinge
- ▶ For cutting aluminum, copper, and thin-walled steel tubes (especially for V2A-/INOX tubes), incl. 1 cutting wheel in rotary handle, cutting wheel changing without tools, article 6222 + 6223 with 4 rollers for optimum support of the pipe during cutting and integrated NOGA deburring blade

Art.-Nr./Art.-No.	Größe/Size	€
396221	3 – 30 mm	
396297-01	Ersatzrädchen 19 x 5 für INOX/V2A	

Art.-Nr./Art.-No.	Größe/Size	€
6222	3 – 35 mm	
396297-01	Ersatzrädchen 19 x 5 für INOX/V2A	

Art.-Nr./Art.-No.	Größe/Size	€
6223	3 – 45 mm	
396279-01	Ersatzrädchen 19 x 5 für INOX/V2A	

Sanitärwerkzeuge

Sanitary Tools

Art.-Gruppe 190
Article Group 190

PROFESSIONAL PLUS STANDARD

Rohrabschneider INOX KOMPAKT QUICK

Tube Cutter INOX KOMPAKT QUICK



- ▶ Zum Schneiden von Aluminium, Kupfer und dünnwandigen Stahlrohren (speziell für V2A-/INOX-Rohre geeignet), inkl. 1 Ersatzrädchen im Drehknopf, Schneidrädchen-Wechsel ohne Werkzeug, mit 4 Führungsrollen für einen optimalen Halt des Rohres beim Schneiden und Schnellvorschub

- ▶ For cutting aluminum, copper, and thin-walled steel tubes (especially for V2A-/INOX tubes), incl. 1 cutting wheel in rotary handle, cutting wheel changing without tools, with 4 rollers for optimum support of the pipe during cutting and fast feed

Art.-Nr./Art.-No.	Größe/Size	€
6224	6 – 67 mm	
6297-05	Ersatzrädchen 19 x 6,2 für V2A/INOX	

PROFESSIONAL PLUS STANDARD

Rohrabschneider Satz

Tube Cutter Set

2
tlg./pcs.



- ▶ Zum Schneiden von Aluminium, Kupfer und dünnwandigen Stahlrohren

- ▶ For cutting aluminum, copper and thin-walled steel tubes

Art.-Nr./Art.-No.	Größe/Size	€
9986	KOMPAKT Mini 3 – 30 mm + KOMPAKT 3 – 45 mm	

Bestehend aus Artikel 6211 + 396213
Content item 6211 + 396213

PROFESSIONAL PLUS STANDARD

Wasserhahnventil-Sitzfräser

Water Tap Milling Cutter

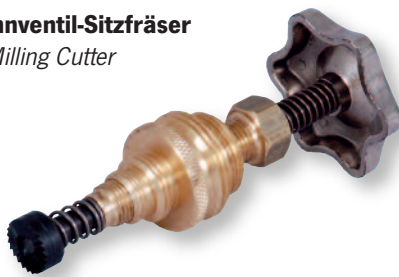

- ▶ inkl. 4 Fräser (3/8" – 1/2" – 3/4" – 1")
- ▶ incl. 4 Milling Cutter (3/8" – 1/2" – 3/4" – 1")

Art.-Nr./Art.-No.	Größe/Size	€
6271	3/8" – 1" (14 – 28 mm)	

PROFESSIONAL PLUS STANDARD

Fräse

Milling Cutter

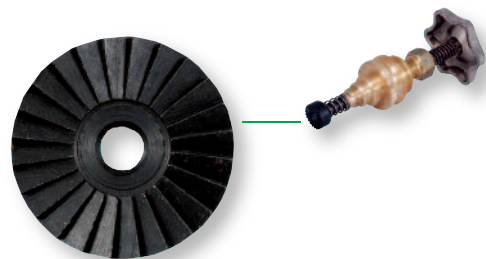

Art.-Nr./Art.-No.	Größe/Size	€
6271-10	1/8" (10 mm)	
6271-12	1/4" (12 mm)	
6271-14	3/8" (14 mm)	
6271-17	1/2" (17 mm)	
6271-20	5/8" (20 mm)	
6271-24	3/4" (24 mm)	
6271-28	1" (28 mm)	

Sanitärwerkzeuge

Sanitary Tools

Art.-Gruppe 190
Article Group 190

PROFESSIONAL PLUS STANDARD

Kunststoff-Rohrschere

Plastic Tube Cutter



6261-01



6261

- ▶ Zum Schneiden von Kunststoff und Verbundrohren mit optimaler Kraftübertragung
- ▶ Klingenswechsel ohne Werkzeug
- ▶ Mit INOX-Klinge 'Made in Solingen'
- ▶ Automatischer Klingens-Rückzug
- ▶ For cutting plastic tubes with optimal power transmission
- ▶ Cutting wheel changing without tools
- ▶ With INOX blade 'Made in Solingen'
- ▶ Automatic blade return

Art.-Nr./Art.-No.	Größe/Size	€
6261	26 mm / 1"	
6261-01	Ersatz-Klinge/Blade	

PROFESSIONAL PLUS STANDARD

Kunststoff-Rohrschere

Plastic Tube Cutter



6263-01



6263

- ▶ Zum Schneiden von Kunststoff und Verbundrohren mit optimaler Kraftübertragung
- ▶ Klingenswechsel ohne Werkzeug
- ▶ Mit INOX-Klinge 'Made in Solingen'
- ▶ Schnellrückzug der Klinge durch Knopfdruck
- ▶ For cutting plastic tubes with optimal power transmission
- ▶ Cutting wheel changing without tools
- ▶ With INOX blade 'Made in Solingen'
- ▶ Fast blade return by pushing the button

Art.-Nr./Art.-No.	Größe/Size	€
6263	42 mm / 1 5/8"	
6263-01	Ersatz-Klinge/Blade	

PROFESSIONAL PLUS STANDARD

Spezialschlüssel Sanitär

Sanitary Wrench

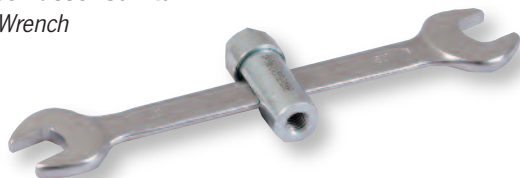

Art.-Nr./Art.-No.	Größe/Size	€
6252	17 x 19 mm, M10	

PROFESSIONAL PLUS STANDARD

Umsteckknarren-Set für 1/2" Vierkant-Antrieb, 3-tlg.

Ratchet Handle for 1/2" Drive, Set 3 pieces

3
tlg./pcs.

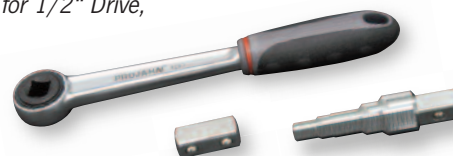

Art.-Nr./Art.-No.	Größe/Size	€
4297-10	1/2" Knarre/ratchet, 251 mm, 1/2" Vierkant, Stufenschlüssel 3/8", 29/64", 31/64", 21/32", 53/64"	

PROFESSIONAL PLUS STANDARD

Sanitärkreuzschlüssel

Sanitary Cross Wrench



Art.-Nr./Art.-No.	Größe/Size	€
6253	200 x 200 mm	
	10 mm - 3/8"	
	12 mm - 1/2" - M8	
	17 mm - 3/4" - M10	
	22 mm - 1" - M12	

PROFESSIONAL PLUS STANDARD

Umsteckknarre für 1/2" Vierkant-Antrieb

Ratchet Handle for 1/2" Drive

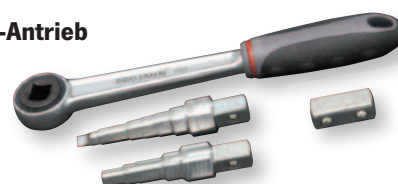

Art.-Nr./Art.-No.	Größe/Size	€
4297	1/2" Knarre/Ratchet, 251 mm	
4297-1	1/2" Vierkant	
4297-2	Stufenschlüssel, 5-stufig 3/8", 29/64", 31/64", 21/32", 53/64"	
4297-3	Stufenschlüssel, 8-stufig 7/8", 27/32", 3/4", 35/64", 1/2", 15/32", 7/16", 3/8" Schraubendreher-Klinge für Schlitzschrauben	

Sanitärwerkzeuge / Teleskop-Magnetheber

Sanitary Tools / Magnetic Pick Up Tools

Art.-Gruppe 190
Article Group 190

PROFESSIONAL PLUS STANDARD

Standhahn-Mutter Schlüssel

Basin Wrench



Art.-Nr./Art.-No.	Länge/Length	€
6251	240 mm	

PROFESSIONAL PLUS STANDARD

Blech-Locher

3-schneidig, Bleche bis 1,5 mm/

VA-Bleche bis 1,2 mm

3-blade Hole Punch

Steel Sheet up to 1,5 mm/

VA-Steel Sheet up to 1,2 mm



Art.-Nr./Art.-No.	Größe/Size	€
6241	32 mm	
6242	35 mm	
6241-1	Ersatz-Schraube/Screw M10 x 1	

PROFESSIONAL PLUS STANDARD

Innen- und Außen-Rohrentgrater

Inside/Outside

Tube Deburrer

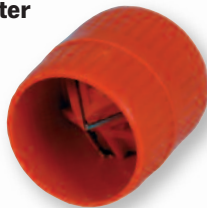

- ▶ Zum Entgraten von harten Kunststoff- + Metall-Rohren
- ▶ Körper aus ABS
- ▶ Klingen 'Made in Solingen'
- ▶ For deburring of hard plastic + metal tubes • ABS body
- ▶ Blades 'Made in Solingen'

Art.-Nr./Art.-No.	Größe/Size	€
6258	3 – 42 mm	

PROFESSIONAL PLUS STANDARD

3196

Teleskop-Magnetheber

Magnetic Pick Up Tool



- ▶ Bis 2 kg Hubkraft
- ▶ 130 – 630 mm ausziehbar
- ▶ Großer Dauermagnet und Clip
- ▶ Up to 2 kg
- ▶ 130 – 630 mm
- ▶ With big magnet

Art.-Nr./Art.-No.	Länge/Length	€
3196	130 - 630 mm ausziehbar	

PROFESSIONAL PLUS STANDARD

3197

NEU/NEW

2-in-1 Pick-up Magnetheber

2-in-1 Magnetic Pick Up Tool

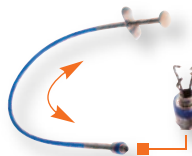

- ▶ Heben von Kleinteilen aus Hohl- u. Zwischenräumen
- ▶ Hebekraft ca. 6 – 8 N, entspricht ca. 0,6 – 0,8 kg
- ▶ Greifer für nichtmetallische Teile
- ▶ Flexibel: Auch um Ecken und Kanten einsetzbar
- ▶ Lifting small things in narrow spaces
- ▶ Lifting force ca. 6 – 8 N, according ca. 0,6 – 0,8 kg
- ▶ Picker for non-metallic things
- ▶ Flexible: Can also be used around corners and edges

Art.-Nr./Art.-No.	Länge/Length	€
3197	600 mm flexibel	

Feilen und Raspeln

Files and Rasps

Art.-Gruppe 181
Article Group 181

PROFESSIONAL PLUS STANDARD

Raspel, flach, 200 mm

Flat Rasp, 200 mm



Art.-Nr./Art.-No.	Typ/Model	€
3386-2	Hieb 2 (Halbschlicht)	

PROFESSIONAL PLUS STANDARD

Raspel, halbrund, 200 mm

Half Round Rasp, 200 mm



Art.-Nr./Art.-No.	Typ/Model	€
3387-1	Hieb 1 (Bastard)	
3387-2	Hieb 2 (Halbschlicht)	
3387-3	Hieb 3 (Schlicht)	

PROFESSIONAL PLUS STANDARD

Raspel, rund, 200 mm

Round Rasp, 200 mm

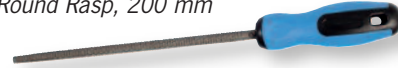

Art.-Nr./Art.-No.	Typ/Model	€
3388-2	Hieb 2 (Halbschlicht)	

PROFESSIONAL PLUS STANDARD

Flachfeile, 200 mm

Flat File, 200 mm



Art.-Nr./Art.-No.	Typ/Model	€
3381-1	Hieb 1 (Bastard)	
3381-2	Hieb 2 (Halbschlicht)	
3381-3	Hieb 3 (Schlicht)	

PROFESSIONAL PLUS STANDARD

Rundfeile, 200 mm

Round File, 200 mm



Art.-Nr./Art.-No.	Typ/Model	€
3383-1	Hieb 1 (Bastard)	
3383-2	Hieb 2 (Halbschlicht)	
3383-3	Hieb 3 (Schlicht)	

PROFESSIONAL PLUS STANDARD

Dreikantfeile, 200 mm

Three Square File, 200 mm



Art.-Nr./Art.-No.	Typ/Model	€
3385-1	Hieb 1 (Bastard)	
3385-2	Hieb 2 (Halbschlicht)	
3385-3	Hieb 3 (Schlicht)	

PROFESSIONAL PLUS STANDARD

Halbrundfeile, 200 mm

Half Round File, 200 mm



Art.-Nr./Art.-No.	Typ/Model	€
3382-1	Hieb 1 (Bastard)	
3382-2	Hieb 2 (Halbschlicht)	
3382-3	Hieb 3 (Schlicht)	

PROFESSIONAL PLUS STANDARD

Vierkantfeile, 200 mm

Square File, 200 mm



Art.-Nr./Art.-No.	Typ/Model	€
3384-1	Hieb 1 (Bastard)	
3384-2	Hieb 2 (Halbschlicht)	
3384-3	Hieb 3 (Schlicht)	

PROFESSIONAL PLUS STANDARD

5-teiliger Satz in Rolltasche

5 Pieces Set in Pouch

5
tlg./pcs.

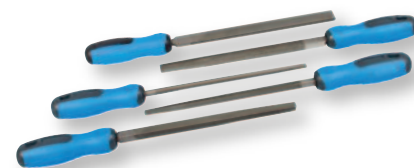

Flachfeile, Rundfeile, Dreikantfeile, Halbrundfeile, Vierkantfeile, Hieb 2

Flat File, Round File, Three Square File, Half Round File, Square File, Hieb 2

Art.-Nr./Art.-No.	€
3380	Set 5-teilig
3380E	Rolltasche leer/empty pouch

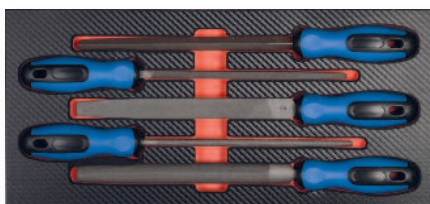

Weitere PROForm-Werkstatteinlagen ab Seite /
More PROForm Inlays for Roller Cabinet from Page H 36

Drahtbürsten

Wire Hand Brushes

Art.-Gruppe 181
Article Group 181

PROFESSIONAL PLUS STANDARD

Stahl-Drahtbürste
glatt, Ø 0,30 – 0,35 mm,
vergüteter Stahldraht

Steel Wire Hand Brush
Straight Wire, Ø 0,30 – 0,35 mm,
Tempered Steel Wire



Art.-Nr./Art.-No.	Typ/Model	€
3375-2	2-Reihig/2 Rows	
3375-3	3-Reihig/3 Rows	
3375-4	4-Reihig/4 Rows	
3375-5	5-Reihig/5 Rows	

PROFESSIONAL PLUS STANDARD

Messing-Drahtbürste
gewellt, Ø 0,25 – 0,30 mm

Brass Wire Hand Brush
Crimped, Ø 0,25 – 0,30 mm

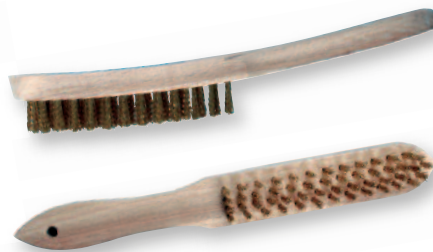
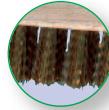

Art.-Nr./Art.-No.	Typ/Model	€
3377-3	3-Reihig/3 Rows	
3377-4	4-Reihig/4 Rows	

PROFESSIONAL PLUS STANDARD

V2A-Drahtbürste
gewellt, Ø 0,30 – 0,35 mm

Stainless Steel Wire Hand Brush
Crimped, Ø 0,30 – 0,35 mm

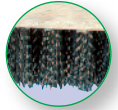

Art.-Nr./Art.-No.	Typ/Model	€
3376-3	3-Reihig/3 Rows	
3376-4	4-Reihig/4 Rows	

PROFESSIONAL PLUS STANDARD

Zündkerzen-Bürste
gewellt, Messing-Draht,
Ø 0,15 mm

Spark Plug Hand Brush
Crimped, Brass Wire, Ø 0,15 mm

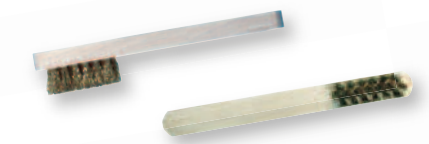
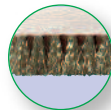

Art.-Nr./Art.-No.	Typ/Model	€
3379	3-Reihig/3 Rows	

PROFESSIONAL PLUS STANDARD

Feilen-Bürste
Nutzfläche ca. 115x40 mm

File Cleaner Hand Brush
Useable Surface ca. 115x40 mm

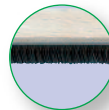

Art.-Nr./Art.-No.	Typ/Model	€
3378	115 x 40 mm	

Messwerkzeuge

Measuring Tools

Art.-Gruppen 180/182
Article Groups 180/182

PROFESSIONAL PLUS **STANDARD**

Rollmeter

Measuring Tape



- ▶ Abnehmbarer Gürtelclip
- ▶ Bandfeststeller und automatischer Bandrücklauf
- ▶ Nach CE-Norm, Präzisionsklasse II

- ▶ Removable belt-clip
- ▶ Blade-lock and automatic-return
- ▶ According to CE-Norms, precision-class II

Art.-Nr./Art.-No.	Länge/Length	€
3963	3 m	
3965	5 m	
3968	8 m	

PROFESSIONAL **PLUS** STANDARD

Rollmeter, 3 m

Measuring Tape

Rollmeter, 5 m

Measuring Tape

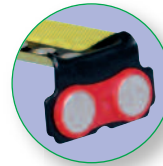

zusätzlich mit
starkem Magnet/
additional with
strong magnet



397312
Display mit/with 12x 3973



397512
Display mit/with 12x 3975

Art.-Nr./Art.-No.	Länge/Length	€
3973	3 m	
397312	Display mit 12x 3973	
3975	5 m	
397512	Display mit 12x 3975	

PROFESSIONAL PLUS **STANDARD**

Gliedermaßstab aus Kunststoff

Foldable Plastic Ruler

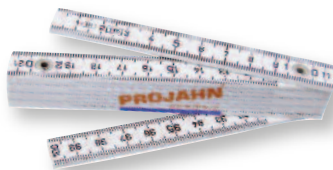

Art.-Nr./Art.-No.	Länge/Length	€
3961	1 m	

PROFESSIONAL PLUS **STANDARD**

Gliedermaßstab aus Holz

Foldable Wooden Ruler



Art.-Nr./Art.-No.	Länge/Length	€
2978	EG-Klasse 3, 2 m	

PROFESSIONAL PLUS **STANDARD**

Zimmermanns-Bleistift, ungespitzt, eckig-oval

Carpenter's Pencil,
Unsharpened, Square-Oval



Art.-Nr./Art.-No.	Länge/Length	€
2979	24 cm	

Messwerkzeuge / Sonstige Werkzeuge

Measuring Tools / Other Tools

Art.-Gruppen 180/182
Article Groups 180/182

PROFESSIONAL PLUS STANDARD

Aluminium-Wasserwaage mit 2 Libellen

- ▶ Max. Messtoleranz in Standardposition 1,0 mm/m (0,057°)
- ▶ Waagrechtlibelle mit Leuchtbelag
- ▶ Stoßdämpfende Endkappen

Spirit Level with 2 Vials

- ▶ Max. measuring tolerance in standard position 1,0 mm/m (0,057°)
- ▶ Horizontal vial with luminous backing
- ▶ Shock-absorbing end caps



Art.-Nr./Art.-No.	Größe/Size	€
2977-040	40 cm	
2977-060	60 cm	
2977-080	80 cm	
2977-100	100 cm	

PROFESSIONAL PLUS STANDARD

Schieblehre

aus rostfreiem Stahl, Schieber + Schiene matt verchromt, für Außen-, Innen- und Tiefenmessungen

Precision Vernier Caliper

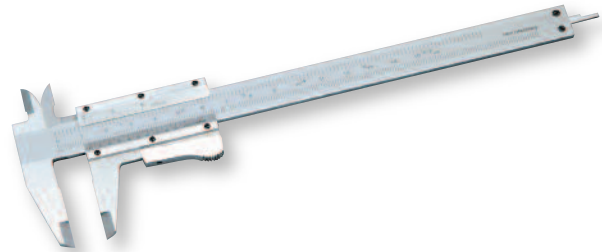

Art.-Nr./Art.-No.	Messbereich/Range	Ableseung/Graduation	€
2970	0-150 mm/0-6"	1/20 mm 1/128"	

PROFESSIONAL PLUS STANDARD

Schlagschnur-Roller 30 m, Kunststoffgehäuse

Chalk Liner

30 m, Plastic Cover



Art.-Nr./Art.-No.	Länge/Length	€
2390	30 m	

PROFESSIONAL PLUS STANDARD

Farbpulver für Schlagschnur-Roller

Powder for Chalk Liner



Art.-Nr./Art.-No.	Farbe/Color	Menge/Quantity	€
2393-1	Blau/Blue	100 g	
2393-2	Rot/Red	100 g	
2394-1	Blau/Blue	500 g	
2394-2	Rot/Red	500 g	

PROFESSIONAL PLUS STANDARD

3059

Schraubenausdreher Satz

Screw Extractor Set

6
tlg./pcs.



Zum Ausdrehen von abgebrochenen Schrauben und Bolzen M3 – M24 – 1/8" – 1"

To extract broken screws and nuts M3 – M24 and 1/8" – 1"

Art.-Nr./Art.-No.	Nummer/no.	Größe/Size	Bohrergrößen zum Vorbohren/Size of drill	€
3059	Nr. 1	M3 – M6 (1/8" – 1/4")	1,8 mm	
	Nr. 2	M6 – M8 (1/4" – 5/16")	3,2 mm	
	Nr. 3	M8 – M11 (5/16" – 7/16")	4,5 mm	
	Nr. 4	M11 – M14 (7/16" – 9/16")	6,5 mm	
	Nr. 5	M14 – M18 (9/16" – 3/4")	8,5 mm	
	Nr. 6	M18 – M24 (3/4" – 1")	12,0 mm	

Messer und Sägen

Knives and Saws

Art.-Gruppe 180
Article Group 180

PROFESSIONAL PLUS STANDARD

3311

**Cutter Messer mit einziehbarer Klinge,
Klingenbreite: 18 mm**

*Utility Knife with Rectangular Blade,
Blade width: 18 mm*

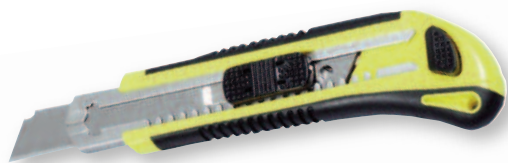

3311-1

10 Ersatzklingen für 3311
10 blades for 3311

331112

Display mit/with 12x 3311

PROFESSIONAL PLUS STANDARD

3312

SICHERHEITS-Cutter Messer mit Automatik-Klinge

► **Automatischer Klingeneinzug verhindert Verletzungen**

SECURITY Utility Knife with Automatic Blade

► *Automatic blade prevents physical injury*



331224

Display mit/with 24x 3312

PROFESSIONAL PLUS STANDARD

3301

**Messer
mit einziehbarer Klinge
und Schutzköcher**

*Knife with
Rectangular
Blade*



PROFESSIONAL PLUS STANDARD

3303

**10 Ersatzklingen
zu 3301 / 3306 / 3312**

10 Blades



PROFESSIONAL PLUS STANDARD

3306

**Messer
mit einziehbarer Klinge**

*Knife with
Rectangular Blade*

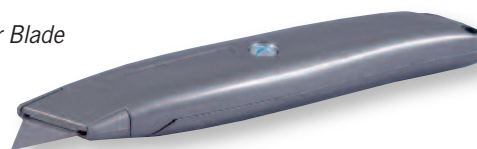

Art.-Nr./Art.-No.	Beschreibung/Discription	€
3311	Cutter Messer, 18 mm	
3311-1	10 Ersatzklingen für 3311	
331112	Display mit 12x 3311	
3303	10 Ersatzklingen für 3301, 3306, 3312	

Art.-Nr./Art.-No.	Beschreibung/Discription	€
3312	Cutter Messer, Automatik-Klinge	
331224	Display mit 24x 3312	
3301	Cutter mit Köcher	
3306	Messer mit einziehbarer Klinge	

Messer und Sägen / Schaltschrankschlüssel

Knives and Saws / Control Cabinet Key

Art.-Gruppe 180
Article Group 180

PROFESSIONAL PLUS STANDARD

3307

PUK Handsäge
PUK Hand Saw



Art.-Nr./Art.-No.	Größe/Size	€
3307	PUK Handsäge Nr. 305	
3307-1	Universal-Sägeblatt 10 x 25 Nr. 310	
3307-2	Metall-Sägeblatt 12 x 32 Nr. 312	

PROFESSIONAL PLUS STANDARD

3305

Metallsägebogen 300 mm
Hack Saw



Bi-Metall

- ▶ Mit verchromtem Vierkant-Stahlrohrbügel
- ▶ Ersatzsägeblätter/Single Blades (Art. 6530024)

Art.-Nr./Art.-No.	Beschreibung/Discription	€
3305	Metallsägebogen/Hack Saw	
6530024	Ersatzblätter/Single Blades	

PROFESSIONAL PLUS STANDARD

3304

Kleinhandsägebogen 260 mm
Mini Hack Saw 260 mm

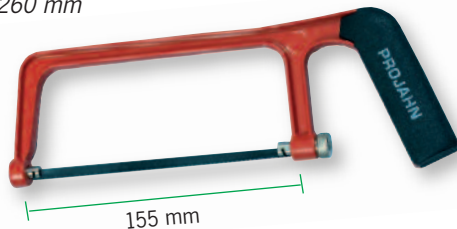

Art.-Nr./Art.-No.	Größe/Size	€
3304	Kleinhandsägebogen 260 mm	
3304-1	Sägeblatt/Saw Blade 155 mm	

PROFESSIONAL PLUS STANDARD

398001

Knie- und Werkzeugunterlage
440 x 270 x 32 mm
Workpad
440 x 270 x 32 mm



Art.-Nr./Art.-No.	Größe/Size	€
398001	Knieunterlage 440 x 270 x 32 mm	

PROFESSIONAL PLUS STANDARD

398005

NEU/NEW

16-in-1 Universal-Schaltschrankschlüssel
16-in-1 Universal Control Cabinet Key

- 7 - 8 mm 7 mm
- 3 - 5 mm PH 2
- Bithalter/Bitholder
- 6 - 7 - 8 - 9 mm
- 7 - 8 - 9 - 10 - 11 mm



- ▶ **16 Funktionen in einem Schlüssel**
- ▶ **Zum Öffnen von Absperrpfosten, Schaltschränken etc.**
- ▶ **Ideal für Heizungs-, Sanitär-, Elektro-, Klima- und Belüftungstechnik in Industrie und Gebäudetechnik**
- ▶ **Wende-Bit mit Magnethalterung inkl. PH2 + Schlitz-Bit**
- ▶ **Hochwertige Zink-Druckguss-Schiebekonstruktion**
- ▶ *16 functions in one key*
- ▶ *To open barriers, control cabinets etc.*
- ▶ *Ideal for sanitary and heading technologie, electrical and ventilation engineering and facility management*
- ▶ *Both sides bit with magnetic holder incl. PH2 + slotted bit*
- ▶ *High-quality zinc diecast sliding construction*

Art.-Nr./Art.-No.	Länge/Length	€
398005	130 - 630 mm ausziehbar	

Schraubzwingen

Screw Clamps

Art.-Gruppe 181
Article Group 181

PROFESSIONAL PLUS STANDARD

Temperguss Schraubzwinde nach DIN 5117 schwere verzinkte Spannarme, verzinkte Hohlprofil-Schiene mit 6-seitiger Riffelung

Screw clamps according to DIN 5117

arms of best malleable cast iron, zincered, double-profiled bar
with 6-sides grooved

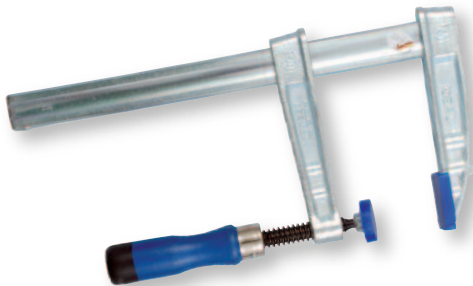

Art.-Nr./Art.-No.	Größe/Size	Schiene/Bar	€
2941-0160	160 x 80 mm	25 x 6 mm	
2941-0200	200 x 100 mm	30 x 8 mm	
2941-0250	250 x 120 mm	30 x 8 mm	
2941-0300	300 x 140 mm	35 x 9 mm	
2941-0400	400 x 175 mm	35 x 9 mm	
2941-0500	500 x 120 mm	35 x 11 mm	
2941-0600	600 x 120 mm	35 x 11 mm	
2941-0800	800 x 120 mm	35 x 11 mm	
2941-1000	1000 x 120 mm	35 x 11 mm	
2941-1250	1250 x 120 mm	35 x 11 mm	

PROFESSIONAL PLUS STANDARD

Ganzstahl Schraubzwinde Festbügel aus kaltgezogenem Profilstahl, Gleitbügel gesenkgeschmiedet

All-steel clamps

spring tempered profiled bar,
moveable arm drop-forged

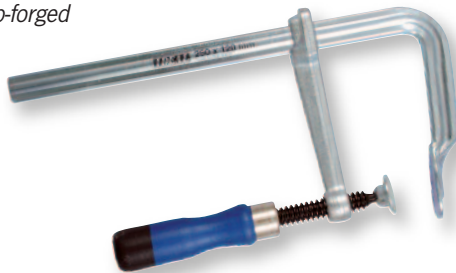

Art.-Nr./Art.-No.	Größe/Size	Schiene/Bar	€
2942-0160	160 x 80 mm	16,0 x 7,5 mm	
2942-0200	200 x 100 mm	19,5 x 9,5 mm	
2942-0250	250 x 120 mm	22,0 x 10,5 mm	
2942-0300	300 x 140 mm	25,0 x 12,0 mm	
2942-0400	400 x 120 mm	25,0 x 12,0 mm	
2942-0500	500 x 120 mm	25,0 x 12,0 mm	

PROFESSIONAL PLUS STANDARD

Ganzstahl Hebelzwinde zum schnellen und mühelosen Spannen mit hohem Spanndruck mit selbstarretierendem spannhebelbetätigtem Rastzahnsegment

All-steel clamps with quick-lever handle



Art.-Nr./Art.-No.	Größe/Size	Schiene/Bar	€
2943-0160	160 x 80 mm	16,0 x 7,5 mm	
2943-0250	250 x 120 mm	22,0 x 10,5 mm	
2943-0400	400 x 120 mm	25,0 x 12,0 mm	

Werkzeugkoffer

Tool Case

Art.-Gruppe 111
Article Group 111

4963

Werkzeug-Trolley

Tool Trolley



Abschließbare Bügelschlösser/
Lockable U-Locks



Einrastender Teleskopgriff/
Telescopic Snap-Handle



Haltbare Scharniere/
Hard-Wearing Hinges



Robuste Rollen/
Robust Castors



Stabile Füße/
Solid Feet



Art.-Nr./Art.-No.	L./L.	B./W.	H./H.	tlg./pcs.	€
4963	390	450	170	1	Werkzeug-Trolley leer/empty tool trolley

8681K

Werkzeugkoffer

Tool Case



Art.-Nr./Art.-No.	L./L.	B./W.	H./H.	tlg./pcs.	€
8681K	460	330	145	1	Werkzeugkoffer leer/empty tool case
8682K	425	280	130	1	Werkzeugkoffer leer/empty tool case
8683K	460	330	145	1	Werkzeugkoffer leer/empty tool case
8684K	460	330	145	1	Werkzeugkoffer leer/empty tool case
8685K	460	330	145	1	Werkzeugkoffer leer/empty tool case



**Alle Module aus dem Kapitel
SYSTEMWAND finden Sie unter:**

All System Wall Racks you find at:

www.projahn.de/qr/pos/systemwand

NEU/NEW



**Alle Produkte aus dem Kapitel
WERBEMITTEL finden Sie unter:**

All Give-Aways you find at:

www.projahn.de/qr/werbemittel

Allgemeine Geschäftsbedingungen der PROJAHN Präzisionswerkzeuge GmbH

Gültig seit 1. April 2013. Hiermit verlieren alle vorherigen AGB ihre Gültigkeit!

1. Allgemeines

- 1.1 Unsere Lieferungen, Leistungen und Angebote erfolgen ausschließlich auf Grund dieser Geschäftsbedingungen. Diese gelten somit auch für alle künftigen Geschäftsbeziehungen, auch wenn sie nicht nochmals ausdrücklich vereinbart werden. Spätestens mit der Entgegennahme der Ware oder Leistung gelten diese Bedingungen als angenommen. Gegenbestätigungen des Käufers unter Hinweis auf seine Geschäfts- bzw. Einkaufsbedingungen wird hiermit widersprochen.
- 1.2 Alle Vereinbarungen, die zwischen uns und dem Käufer zwecks Ausführung dieses Vertrages getroffen werden, sind schriftlich niederzulegen.

2. Erfüllungsort, Gefahrübergang, Versicherung

- 2.1 Erfüllungsort für Lieferung und Zahlung ist Dietzenbach.
- 2.2 Die Gefahr geht auf den Käufer über, sobald die Sendung, an die den Transport ausführende Person, übergeben worden ist oder zwecks Versendung unser Lager verlassen hat. Wird der Versand auf Wunsch des Käufers verzögert, geht die Gefahr mit der Meldung der Versandbereitschaft auf ihn über.

3. Angebote und Preise

- 3.1 Die Darstellung unserer Waren im Internet oder im Katalog beinhaltet kein bindendes Angebot. Es handelt sich um eine Aufforderung an unsere Kunden, uns ein verbindliches Angebot zu unterbreiten.
- 3.2 Die Bestellung unseres Kunden stellt ein verbindliches Angebot auf Abschluss eines Kaufvertrages über die bestellte Ware dar. Soweit wir den Zugang der Bestellung bestätigen, stellt dies keine verbindliche Annahme der Bestellung dar.
- 3.3 Der Kaufvertrag kommt erst zu Stande, wenn wir dem Käufer eine verbindliche Auftragsbestätigung übermitteln oder die bestellte Ware an ihn versenden.
- 3.4 Wenn wir ein Angebot unterbreiten, ist dieses freibleibend und unverbindlich. Annahmeerklärungen und sämtliche Bestellungen bedürfen zur Rechtswirksamkeit unserer schriftlichen oder fernschriftlichen Bestätigung.
- 3.5 Sowohl Preisänderungen, als auch technische Änderungen bleiben uns vorbehalten. Unsere Produktabbildungen im Katalog und im Internet sind unverbindlich. Des Weiteren wird jegliche Haftung für Druckfehler ausgeschlossen.
- 3.6 Es gilt jeweils die am Tage der Bestellung gültige Preisliste.
- 3.7 Die Preise verstehen sich zuzüglich der jeweiligen gesetzlichen Umsatzsteuer.
- 3.8 Im Katalog sind zu den jeweiligen Produkten die entsprechenden Verpackungseinheiten genannt. Die Verpackungseinheiten verstehen sich als Mindestabnahmemenge. Im Falle einer Minderbestellung erhöhen wir diese automatisch auf die entsprechende Verpackungseinheit. Diese Vorgehensweise bedarf nicht der ausdrücklichen Zustimmung des Bestellers.

4. Versandkosten

Sind keine abweichenden Vereinbarungen getroffen, gilt folgendes:

- 4.1 Unsere Preise verstehen sich „ab Werk“, ausschließlich Verpackung.
- 4.2 Ab Euro 250,- Netto-Auftragswert liefern wir innerhalb Deutschlands frei Haus, inklusive Verpackung.
- 4.3 Bei Inlandsaufträgen unter Euro 50,- Netto-Auftragswert wird ein Mindermengenzuschlag von Euro 5,- berechnet.

5. Liefer- und Leistungszeit

- 5.1 Liefertermine oder -fristen, die verbindlich oder unverbindlich vereinbart werden können, bedürfen der Schriftform.
- 5.2 Liefer- und Leistungsverzögerungen auf Grund höherer Gewalt und auf Grund von Ereignissen, die uns die Lieferung nicht nur vorübergehend wesentlich erschweren oder unmöglich machen – hierzu gehören insbesondere Streik, Aussperrung, behördliche Anordnungen usw., auch wenn sie bei unserem Lieferanten oder deren Unterlieferanten eintreten – haben wir auch bei verbindlich vereinbarten Fristen und Terminen nicht zu vertreten. Sie berechtigen uns, die Lieferung bzw. Leistung um die Dauer der Behinderung, zuzüglich einer angemessenen Anlaufzeit, hinauszuschieben oder wegen des noch nicht erfüllten Teils ganz oder teilweise vom Vertrag zurückzutreten. Wenn die Behinderung länger als drei Monate dauert, ist der Käufer nach angemessener Nachfristsetzung berechtigt, hinsichtlich des noch nicht erfüllten Teils vom Vertrag zurückzutreten. Verlängert sich die Lieferzeit oder werden wir von unserer Verpflichtung frei, so kann der Käufer hieraus keine Schadensersatzansprüche herleiten. Auf die genannten Umstände können wir uns nur berufen, wenn wir den Käufer unverzüglich benachrichtigt haben.
- 5.3 Wir sind zu Teillieferungen und Teilleistungen jederzeit berechtigt, es sei denn die Teillieferung oder Teilleistung ist vom Käufer bei Vertragsschluss ausgeschlossen worden.
- 5.4 Die Einhaltung der Liefer- und Leistungsverpflichtungen unsererseits, setzt die rechtzeitige und ordnungsgemäße Erfüllung der Verpflichtungen des Käufers voraus.
- 5.5 Kommt der Käufer in Annahmeverzug, so sind wir berechtigt, Ersatz des uns entstehenden Schadens zu verlangen. Schadensersatz wegen Nichterfüllung können wir pauschaliert in Höhe von 15% des vereinbarten Kaufpreises verlangen, es sei denn, der Käufer beweist, dass unser Schaden geringer ist oder wir weisen nach, dass der Schaden höher ist.
- 5.6 Mit Eintritt des Annahmeverzugs geht die Gefahr der zufälligen Verschlechterung und des zufälligen Untergangs auf den Käufer über.

6. Sonderwerkzeuge

Wenn wir einen Auftrag für Sonderwerkzeuge annehmen und schriftlich bestätigen, sind wir berechtigt, die Lieferung um eine angemessene Stückzahl zu über- oder unterschreiten.

7. Gewährleistung, Mängelrügen

- 7.1 Die von uns gelieferte Ware ist unverzüglich nach dem Eintreffen am Bestimmungsort mit der Sorgfalt eines ordentlichen Kaufmanns zu untersuchen und zu behandeln. Unterbleibt die Untersuchung, haften wir nicht für Mängel der Ware. Dies gilt entsprechend, wenn später erkennbare Mängel nicht unverzüglich gerügt werden. Mängel sind uns schriftlich, spätestens innerhalb von 8 Tagen nach Warenerhalt, mitzuteilen.
- 7.2 Sachmängel liegen nur vor, wenn die Mängel zum Zeitpunkt der Übergabe vorhanden sind. Deshalb liegen keine Sachmängel vor, wenn die Beanstandungen auf ungeeignete oder unsachgemäße Verwendung unserer Werkzeuge, natürliche Abnutzung, fehlerhafte oder nachlässige Behandlung, sowohl übermäßige Beanspruchung und den Einsatz von ungeeigneten Betriebsmitteln, als auch chemische, elektrochemische oder elektrische Einflüsse zurückzuführen sind, soweit die Verwendbarkeit unter entsprechenden Sonderbedingungen nicht vereinbart war.

- 7.3 Liegen Sachmängel vor, steht uns das Wahlrecht zu, ob die Nacherfüllung durch Nachbesserung oder Nachlieferung erfolgt. Wir haben auch das Recht, eine entsprechende Gutschrift für den gelieferten Artikel zu erstellen.
- 7.4 Auf Sachmängel, die den Wert und die Tauglichkeit der Ware nur unerheblich mindern, kann der Käufer einen Rücktrittsanspruch nicht stützen.

8. Zahlungsbedingungen, Zahlungsverzug

- 8.1 Eine Zahlung gilt erst dann als erfolgt, wenn wir über den Betrag verfügen können. Im Falle von Schecks gilt die Zahlung erst als erfolgt, wenn der Scheck eingelöst wird.
- 8.2 Bei Zahlungen innerhalb von 8 Tagen ab Rechnungsdatum (Eingang Konto) gewähren wir 2% Skonto.
- 8.3 Wir sind berechtigt, trotz anders lautender Bestimmungen des Käufers, Zahlungen zunächst auf dessen ältere Schulden anzurechnen. Wir werden den Käufer über die Art der erfolgten Verrechnung informieren. Sind bereits Kosten und Zinsen entstanden, so sind wir berechtigt, die Zahlung zunächst auf die Kosten, dann auf die Zinsen und zuletzt auf die Hauptleistung anzurechnen.
- 8.4 Der Käufer gerät, ohne dass es einer gesonderten Mahnung bedarf, am 30. Tage nach Rechnungsdatum in Verzug. Bei Zahlungsverzug ist die offene Forderung mit 8% Prozentpunkten über dem jeweiligen Basiszinssatz zu verzinsen. Sie sind dann niedriger anzusetzen, wenn der Käufer eine geringere Belastung nachweist; der Nachweis eines höheren Schadens durch uns ist zulässig.
- 8.5 Der Käufer ist zur Aufrechnung, Zurückbehaltung oder Minderung, auch wenn Mängelrügen oder Gegenansprüche geltend gemacht werden, nur berechtigt, wenn wir ausdrücklich zustimmen oder wenn die Gegenansprüche rechtskräftig festgestellt worden oder unstreitig sind. Zur Zurückbehaltung ist der Käufer nur wegen Gegenansprüchen aus demselben Vertragsverhältnis berechtigt.

9. Eigentumsvorbehalt

- 9.1 Bis zur Erfüllung aller Forderungen (einschließlich sämtlicher Saldoforderungen aus Kontokorrent), die uns aus jedem Rechtsgrund gegen den Käufer jetzt oder künftig zustehen, bleibt die gelieferte Ware in unserem Eigentum.
- 9.2 Der Käufer ist berechtigt, die Vorbehaltsware im ordnungsgemäßen Geschäftsverkehr zu veräußern, solange er nicht in Verzug ist. Verpfändungen oder Sicherungsübereignungen sind unzulässig. Die aus dem Weiterverkauf oder einem sonstigen Rechtsgrund (Versicherung, unerlaubte Handlung) bezüglich der Vorbehaltsware entstehenden Forderungen (einschließlich sämtlicher Saldoforderungen aus Kontokorrent) tritt der Käufer bereits jetzt sicherungshalber in vollem Umfang an uns ab. Wir ermächtigen ihn widerruflich, die an uns abgetretenen Forderungen für dessen Rechnung im eigenen Namen einzuziehen. Diese Einziehungsermächtigung kann nur widerrufen werden, wenn der Käufer seinen Zahlungsverpflichtungen nicht ordnungsgemäß nachkommt.
- 9.3 Bei Zugriffen Dritter auf die Vorbehaltsware, insbesondere Pfändungen, wird der Käufer auf unser Eigentum hinweisen und uns unverzüglich benachrichtigen, damit wir unsere Eigentumsrechte durchsetzen können. Soweit der Dritte nicht in der Lage ist, uns die in diesem Zusammenhang entstehenden gerichtlichen oder außergerichtlichen Kosten zu erstatten, haftet hierfür der Käufer.

- 9.4 Bei vertragswidrigem Verhalten des Käufers – insbesondere Zahlungsverzug – sind wir berechtigt, vom Vertrag zurückzutreten und die Vorbehaltsware heraus zu verlangen.

10. Haftungsbeschränkung

- 10.1 Schadensersatzansprüche sind unabhängig von der Art der Pflichtverletzung, einschließlich unerlaubter Handlungen, ausgeschlossen, soweit nicht vorsätzliches oder grob fahrlässiges Handeln vorliegt.
- 10.2 Bei Verletzung wesentlicher Vertragspflichten haften wir für jede Fahrlässigkeit, jedoch nur bis zur Höhe des vorhersehbaren Schadens. Ansprüche auf entgangenen Gewinn, ersparte Aufwendungen, aus Schadensersatzansprüchen Dritter sowie auf sonstige mittelbare- und Folgeschäden können nicht verlangt werden, es sei denn, ein von uns garantiertes Beschaffenheitsmerkmal bezweckt gerade, den Käufer gegen solche Schäden abzusichern.
- 10.3 Die Haftungsbeschränkungen und -ausschlüsse in den Absätzen 10.1 und 10.2 gelten nicht für Ansprüche, die wegen arglistigen Verhaltens auf unserer Seite entstanden sind, sowie bei einer Haftung für garantierte Beschaffenheitsmerkmale, für Ansprüche nach dem Produkthaftungsgesetz sowie Schäden aus der Verletzung des Lebens, des Körpers oder der Gesundheit.
- 10.4 Soweit unsere Haftung ausgeschlossen oder beschränkt ist, gilt dies auch für unsere Angestellten, Arbeitnehmer, Vertreter und Erfüllungsgehilfen.

11. Datenschutz

Personen- und firmenbezogene Daten werden von uns gespeichert und verarbeitet, soweit dies zur Durchführung der Aufträge notwendig und nach dem Bundesdatenschutzgesetz zulässig ist.

12. Anwendbares Recht, Gerichtsstand, Teilnichtigkeit

- 12.1 Für die gesamten Rechtsbeziehungen zwischen uns und dem Käufer gilt das Recht der Bundesrepublik Deutschland. Die Bestimmungen des UN-Kaufrechts finden keine Anwendung.
- 12.2 Gerichtsstand für alle sich aus dem Vertragsverhältnis unmittelbar oder mittelbar ergebenden Streitigkeiten ist unser Hauptsitz. Wir haben das Recht, Ansprüche auch an einem anderen gesetzlichen Gerichtsstand geltend zu machen.
- 12.3 Sollte eine der vorstehenden Bestimmungen unwirksam sein, bleibt die Wirksamkeit der übrigen Bestimmungen unberührt und die betroffene Bestimmung ist durch eine wirksame Regelung zu ersetzen, die der unwirksamen Bestimmung wirtschaftlich am nächsten kommt.

General Terms and Conditions : PROJAHN Präzisionswerkzeuge GmbH

Valid since April 1, 2013. All foregoing general terms and conditions herewith lose their validity.

Please be advised that general terms and conditions below are a translation of the German general terms and conditions.

The German general terms and conditions are also valid for international business.

1. General

- 1.1 Our deliveries, services and offers are made exclusively on the basis of these terms and conditions, which will also apply to all future business relations even if they are not expressly agreed anew. These terms and conditions are considered agreed upon receipt of the goods or services at the latest. Counter-confirmations on the part of the purchaser with reference to the purchaser's own terms of business or purchase are hereby rejected.
- 1.2 All agreements made between the purchaser and ourselves for the purpose of performance of this contract must be recorded in writing.

2. Place of Performance, Passing of Risk, Insurance

- 2.1 The place of performance for delivery and payment is Dietzenbach.
- 2.2 The risk passes to the purchaser as soon as the consignment has been transferred to the person carrying out the transportation or as soon as it has left our warehouse for the purpose of dispatch. If the dispatch is delayed at the purchaser's request, the risk passes to the purchaser on notification that the consignment is ready for dispatch.

3. Offers and Prices

- 3.1 The presentation of our goods on the internet or in the catalogue does not constitute an offer to which we are bound. It is an invitation to our customers to make us a binding offer.
- 3.2 The order placed by our customer represents a binding offer to conclude a contract of sale relating to the ordered goods. Insofar as we acknowledge receipt of the order, this does not represent binding acceptance of the order.
- 3.3 The contract of sale is brought about only when we forward a binding order confirmation to the purchaser or send the ordered goods to the purchaser.
- 3.4 If we submit an offer, it is non-binding and without engagement. Declarations of acceptance and all orders require our confirmation by letter or by written telecommunication to attain legal validity.
- 3.5 We reserve the right to change prices and to make technical modifications. The images of our products in the catalogue and on the internet are not binding. Furthermore, no liability for printing errors is accepted.
- 3.6 The price list valid on the order date applies.
- 3.7 The prices are subject to VAT at the respective statutory rate.
- 3.8 The catalogue indicates the packaging units corresponding to the respective products. The packaging units are the minimum purchase quantity. If an order for a reduced quantity is placed, we increase the order automatically to the relevant packing unit. This procedure does not require the orderer's express consent.

4. Shipping Costs

Unless agreed otherwise, the following applies:

- 4.1 Our prices are "ex works", excluding packaging.
- 4.2 From a net order value of Euro 250.- upwards, we deliver free domicile within Germany, including packaging.
- 4.3 A mark-up of Euro 5.00 is charged for orders from domestic customers with a net order value of less than Euro 50.-.

5. Delivery and Performance Time

- 5.1 Delivery dates or delivery periods, which may be agreed on a binding or non-binding basis, have to be stated in writing.
- 5.2 We cannot be held responsible for delays in delivery and performance due to force majeure and events which significantly impede or render delivery by us impossible, not merely on a temporary basis – including, in particular, strikes, lockouts, official rulings etc., and inclusive of such events affecting our suppliers and sub-suppliers, even in case of bindingly agreed dates and deadlines. They entitle us to postpone delivery or performance for the duration of the hindrance plus a reasonable lead time, or to withdraw from the contract in whole or in part on account of the part not fulfilled. If the hindrance lasts longer than three months, the purchaser is entitled to withdraw from the unfulfilled part of the contract after having granted a reasonable extension of time. If the delivery period is prolonged or if we are released from our obligations, the purchaser cannot derive any claims for damages from this. We will only have the right to plead the aforementioned circumstances if we have notified the purchaser promptly.
- 5.3 We are entitled to make partial deliveries and render partial performance at any time unless the purchaser excluded partial delivery or partial performance when the contract was concluded.
- 5.4 The adherence to the delivery and performance duties on our part presupposes the punctual and orderly fulfilment of the purchaser's obligations.
- 5.5 If the purchaser defaults on acceptance, we are entitled to claim compensation for the damage or loss we incur. We are entitled to claim liquidated damages for non-fulfilment to the amount of 15% of the agreed purchase price unless the purchaser proves that the damage or loss we incurred is lower or we prove that the damage or loss is higher.
- 5.6 Upon default of acceptance the risk of accidental deterioration and accidental loss passes to the purchaser.

6. Special Tools

If we accept an order for special tools and confirm it in writing, we are entitled to deliver a reasonably higher or lower number of units.

7. Warranty, Notification of Defects

- 7.1 Immediately after the goods we deliver have arrived at their destination, they have to be inspected and handled with the due care and diligence of a prudent businessman. If the goods are not inspected, we cannot be held liable for any defects. This applies analogously if defects identifiable at a later stage are not promptly notified. We are to be notified of any defects in writing, at the latest within 8 days from receipt of the goods.

- 7.2 Defects of quality are constituted only if the defects exist at the time of delivery. Therefore defects of quality are not constituted if the complaints can be put down to unsuitable or improper use of our tools, natural wear, faulty or negligent handling, excessive workloads, the use of unsuitable operating resources, as well as chemical, electrochemical or electrical influences, insofar as the usability under corresponding special conditions was not agreed.
- 7.3 If defects of quality are constituted, we have the right to choose whether the supplementary performance takes the form of rectification or replacement. We also have the right to issue a commensurate credit note for the article supplied.
- 7.4 The buyer is not entitled to base a rescission claim on defects of quality which only insignificantly reduce the value or fitness for use of the goods.

8. Terms of Payment, Default in Payment

- 8.1 Payment will be deemed to have been made only when the sum is at our disposal. In the case of cheques, payment will be deemed to have been made only when the cheque has been cashed.
- 8.2 For payments within 8 days from the date of invoice (receipt on the account) we grant a 2 % discount.
- 8.3 We are entitled, notwithstanding any purchaser's stipulations to the contrary, to post payments first against the purchaser's older debts. We will inform the purchaser of the nature of this settlement. If costs and interest have accrued, we are entitled to post the payment first against the costs, then against the interest and finally against the principal debt.
- 8.4 The purchaser will be in default on the 30th day after the date of invoice, without a separate notice of default having to be served. In case of default in payment, the unsettled claim bears interest at the rate of 8 percentage points above the respective base rate. The interest is to be set at a lower rate if the purchaser provides evidence of a lower burden. It is admissible for us to produce evidence of higher loss.
- 8.5 The purchaser does not have the right to offset, retain or reduce payments, even in the event of complaints or counterclaims, unless we expressly agree to such or the counterclaims have been res judicata or are undisputed. The buyer has a right of retention only due to counterclaims under the same contractual relationship.

9. Reservation of Title

- 9.1 The goods supplied remain our property until settlement of all claims (including all current account balance claims) to which we are entitled from the purchaser on any legal grounds, now or in future.
- 9.2 The goods subject to retention of title may be sold by the purchaser in the ordinary course of business as long as the purchaser is not in default. Pledging or transfer of ownership by way of security is inadmissible. The claims (including all current account balance claims) accruing from the resale or on any other legal grounds (insurance, tort) with respect to the goods subject to retention of title are herewith assigned to us in their entirety by the buyer by way of security. We revocably authorize the purchaser to collect the claims assigned to us, for his account and in his name. This authorization for collection can be revoked only if the purchaser does not duly fulfil his payment obligations.

- 9.3 If a third party attempts to seize the goods subject to retention of title, in particular in case of attachment, the purchaser will draw attention to our ownership and notify us without delay so that we are in a position to enforce our title. If the third party is not in a position to reimburse us for the court and out-of-court costs incurred in this connection, the purchaser will be liable for them.

- 9.4 In case of breach of contract by the purchaser – in particular, default in payment – we are entitled to withdraw from the contract and to demand the return of the goods.

10. Limitation of Liability

- 10.1 Claims for damages are excluded, irrespective of the nature of the breach of obligations, including tort, unless deliberate or grossly negligent acts are involved.
- 10.2 In case of breach of fundamental contractual obligations, we are liable for every act of negligence, but only to the extent of the foreseeable damage or loss. Claims for loss of profit, saved expenditure, third-party claims for damages, and other indirect and consequential damage cannot be made unless a quality feature we guarantee has the express purpose of protecting the purchaser from such damage or loss.
- 10.3 The limitations and exclusions of liability set forth in paragraphs 10.1 and 10.2 do not apply to claims arising as a result of fraudulent conduct on our part, nor to liability for guaranteed quality features, claims under product liability law or damage resulting from injury to life, body and health.
- 10.4 To the extent that our liability is excluded or limited, this also applies to our employees, representatives and persons we engage for fulfilling our obligations.

11. Protection of Data Privacy

We store and process personal and company-related data as far as is necessary for executing the orders and as far as is admissible under the German Federal Data Protection Act (BDSG).

12. Applicable Law, Legal Venue, Severability

- 12.1 All legal relations between the purchaser and ourselves are governed by the laws of the Federal Republic of Germany to the exclusion of the provisions of the United Nations Convention on Contracts for the International Sale of Goods.
- 12.2 The legal venue for all disputes arising directly or indirectly from the contractual relationship is our principal place of business. We have the right to also assert claims at another place of jurisdiction.
- 12.3 Should any one of the above provisions be inoperative, the validity of the other provisions will remain unaffected. The provision concerned is to be replaced by an operative one that most closely resembles the economic intent of the original provision.

Artikelnummern-Verzeichnis

Articlenumber List

Art.-Nr. / No.	Seite / Page	Art.-Nr. / No.	Seite / Page	Art.-Nr. / No.	Seite / Page	Art.-Nr. / No.	Seite / Page	Art.-Nr. / No.	Seite / Page
241719	H147	251819	H147	25654	H148	2678	H170	2735-10	H169
241819	H147	25182	H144	2566	H145	2679	H170	2735-100	H169
242022	H147	2519	H143	2567	H145	2680	H170	2736	H168
242123	H147	25191	H145	2568	H145	2681	H170	2736-10	H169
242426	H147	25192	H144	2569	H145	2683	H170	2736-100	H169
242427	H147	251922	H147	2570	H145	2684	H170	2737	H168
242528	H147	25195	H146	25701	H143	2685	H170	2737-10	H169
243032	H147	2520	H143	2571	H145	2686	H170	2738	H168
243641	H147	25201	H145	2572	H145	2687	H170	2738-10	H169
2440810	H150	252022	H147	2580	H155	2688	H170	2739	H168
2441113	H150	2521	H143	2580E	H155	2690	H178	2739-10	H169
2441416	H150	25211	H145	2588-08	H151	2691	H178	2741	H170
2441719	H150	25212	H144	2588-09	H151	2692	H178	2741-10	H170
250008	H146	252123	H147	2588-10	H151	2696	H170	2742	H170
250010	H146	2522	H143	2588-11	H151	2697	H170	2742-10	H170
250012	H146	25221	H145	2588-12	H151	2698	H170	2743	H170
250013	H146	25222	H144	2588-13	H151	2699	H170	2743-10	H170
250016	H146	252224	H147	2588-14	H151	2700	H105	2744	H170
250017	H146	25225	H146	2588-15	H151	2700	H180	2744-10	H170
250018	H146	2523	H143	2588-16	H151	2700-10	H165	2745	H170
250019	H146	25232	H144	2588-17	H151	2701	H165	2745-10	H170
2505	H143	2524	H143	2588-18	H151	2701-10	H165	2746	H170
2506	H143	25241	H145	2588-19	H151	2701-100	H165	2746-10	H170
250607	H147	25242	H144	2588-20	H151	2702	H165	2747	H169
25062	H144	252426	H147	2588-21	H151	2702-10	H165	2748	H169
25065	H146	252427	H147	2588-22	H151	2702-100	H165	2749	H169
2507	H143	252430	H147	2588-23	H151	2703	H165	2750	H179
25072	H144	25244	H148	2588-24	H151	2703-10	H165	2751	H169
25075	H146	25245	H146	2588-25	H151	2703-100	H165	2752	H169
2508	H143	2525	H143	2588-26	H151	2704	H165	2753	H169
250809	H147	25252	H144	2588-27	H151	2704-10	H165	2754	H169
25081	H145	252528	H147	2588-28	H151	2706	H165	2755	H169
25082	H144	2526	H143	2588-29	H151	2706	H165	2756	H169
25085	H146	25262	H144	2588-30	H151	2707	H165	2757	H169
2509	H143	2527	H143	2588-32	H151	2707	H165	2758	H169
25091	H145	25271	H145	260001	H148	2708	H165	2760	H107
25092	H144	25272	H144	260002	H148	2708	H165	2760	H179
25095	H146	252730	H147	2601	H165	2710-10	H166	2761	H110
2510	H143	252732	H147	2602	H165	2711	H166	2761	H179
251008	H147	25274	H148	2603	H165	2711-10	H166	2764	H179
25101	H145	25275	H146	260607	H148	2711-100	H166	2765	H180
251011	H147	2528	H143	260809	H148	2712	H166	2766	H180
251013	H147	25282	H144	261011	H148	2712-10	H166	2767	H180
25102	H144	2529	H143	2611	H166	2712-100	H166	2769	H179
25105	H146	25292	H144	2612	H166	2713	H166	2770	H179
2511	H143	2530	H143	261213	H148	2713-10	H166	2771-10	H169
25111	H145	25301	H145	2613	H166	2713-100	H166	2772-10	H169
25112	H144	25302	H144	261415	H148	2714	H166	2774-10	H169
25115	H146	253032	H147	261617	H148	2714-10	H166	2775-10	H169
2512	H143	25304	H148	261719	H148	2721	H167	2777-10	H169
25121	H145	25305	H146	261819	H148	2721-10	H167	2778-10	H169
251213	H147	2532	H143	262022	H148	2722	H167	2780-10	H170
25122	H144	25321	H145	262123	H148	2722-10	H167	2781-10	H170
25125	H146	25322	H144	262427	H148	2723	H167	2782-10	H170
2513	H143	25324	H148	2631	H168	2723-10	H167	2783-10	H170
25131	H145	25325	H146	2632	H168	2724	H167	2784-10	H170
251317	H147	25361	H143	2633	H168	2724-10	H167	2785-10	H170
25132	H144	25364	H148	2634	H168	2725	H167	2786-10	H170
25135	H146	253641	H147	2635	H168	2725-10	H167	2787-10	H170
2514	H143	25384	H148	2636	H168	2726	H167	2788-10	H170
25141	H145	25411	H143	2637	H168	2726-10	H167	2801	H165
251415	H147	25414	H148	2651	H178	2727	H167	2801-10	H165
25142	H144	254146	H147	2652	H178	2727-10	H169	2802	H165
25145	H146	25424	H148	2653	H178	2728	H168	2802-10	H165
2515	H143	25461	H143	2656	H178	2728-10	H169	2803	H165
25151	H145	25464	H148	2657	H178	2729	H168	2803-10	H165
25152	H144	254650	H147	2658	H178	2729-10	H169	2804	H165
25155	H146	25484	H148	2661	H178	2731	H168	2811	H166
2516	H143	25501	H143	2662	H178	2731-10	H169	2811-10	H166
25161	H145	25504	H148	2663	H178	2731-100	H169	2812	H166
251617	H147	25551	H143	2665	H178	2732	H168	2812-10	H166
25162	H144	25554	H148	2667	H178	2732-10	H169	2813	H166
25165	H146	25601	H143	2668	H178	2732-100	H169	2813-10	H166
2517	H143	25604	H148	2669	H178	2733	H168	2814	H166
25171	H145	2561	H145	2671	H178	2733-10	H169	2821	H167
251719	H147	2562	H145	2672	H178	2733-100	H169	2822	H167
25172	H144	2563	H145	2673	H178	2734	H168	2823	H167
25175	H146	2564	H145	2674	H178	2734-10	H169	2824	H167
2518	H143	2565	H145	2676	H170	2734-100	H169	2825	H167
25181	H145	25651	H143	2677	H170	2735	H168	2826	H167

Artikelnummern-Verzeichnis

Articlenumber List

Art.-Nr. / No.	Seite / Page	Art.-Nr. / No.	Seite / Page	Art.-Nr. / No.	Seite / Page	Art.-Nr. / No.	Seite / Page	Art.-Nr. / No.	Seite / Page
2831	H168	2942-0400	H243	301211	H113	305010	H176	3095	H170
2831-10	H169	2942-0500	H243	301212	H113	305015	H176	3095	H171
2832	H168	2943-0160	H243	301213	H113	305020	H176	3096	H170
2832-10	H169	2943-0250	H243	301214	H113	305025	H176	3096	H171
2833	H168	2943-0400	H243	301215	H113	305027	H176	3097	H170
2833-10	H169	2950	H25	301216	H113	305030	H176	3097	H171
2834	H168	2951	H25	301217	H113	305040	H176	3098	H170
2834-10	H169	2961	H169	301218	H113	305045	H176	3098	H171
2835	H168	2962	H169	301219	H113	305050	H176	310000	H115
2835-10	H169	2963	H169	301220	H113	305055	H176	3101-10	H165
2836	H168	2964	H169	301221	H113	305060	H176	3102-10	H165
2836-10	H169	2970	H240	301222	H113	305070	H176	3103-10	H165
2837	H168	2977-040	H240	301223	H113	305310	H176	3111-10	H166
2837-10	H169	2977-060	H240	301224	H113	305315	H176	3112-10	H166
2841	H170	2977-080	H240	301226	H113	305320	H176	311214	H113
2842	H170	2977-100	H240	301227	H113	305325	H176	311215	H113
2843	H170	2978	H239	301228	H113	305327	H176	311217	H113
2844	H170	2979	H239	301230	H113	305330	H176	311219	H113
2845	H170	300008	H113	301232	H113	305340	H176	3113-10	H166
2846	H170	300009	H113	301234	H113	305345	H176	311516	H115
2850	H179	300010	H113	301236	H113	305350	H176	311516	H179
2851	H169	300011	H113	3013-10	H166	305355	H176	3130-10	H168
2852	H169	300012	H113	301511	H113	305360	H176	313001	H176
2853	H169	300013	H113	301512	H113	305370	H176	313002	H176
2854	H169	300014	H113	301513	H113	305620	H177	313003	H176
2855	H169	300015	H113	301514	H113	305625	H177	3131-10	H168
2856	H169	300016	H113	301515	H113	305627	H177	3132-10	H168
2857	H169	300017	H113	301516	H113	305630	H177	3133-10	H168
2860	H179	300018	H113	301517	H113	305640	H177	3134-10	H168
2862	H179	300019	H113	301518	H113	305645	H177	3135-10	H168
2864	H179	300020	H113	301519	H113	305650	H177	3136-10	H168
2870	H179	300021	H113	301520	H113	305655	H177	3137-10	H168
2880	H179	300022	H113	302055	H176	305660	H177	3138-10	H168
2880	H192	300023	H113	302065	H176	305670	H177	3139-10	H168
2881	H169	300024	H113	302080	H176	305720	H177	3140-10	H168
2882	H169	300026	H113	302100	H176	305725	H177	314001	H176
2883	H169	300027	H113	302120	H176	305727	H177	314002	H176
2884	H169	300028	H113	3030-10	H168	305730	H177	315015	H176
2885	H169	300030	H113	303001	H176	305740	H177	315020	H176
2886	H169	300032	H113	303002	H176	305745	H177	315025	H176
2887	H169	300034	H113	303003	H176	305750	H177	315027	H176
2890	H178	300036	H113	303004	H176	305755	H177	315030	H176
2891	H178	3001-10	H165	3031	H168	305760	H177	315040	H176
2892	H178	3002	H165	3031	H171	305770	H177	315045	H176
2893	H178	3002	H171	3031-10	H168	3059	H240	315050	H176
2894	H178	3002-10	H165	3032	H168	306004	H176	315055	H176
2895	H178	3003-10	H165	3032	H171	306005K	H176	315060	H176
2901	H165	300509	H113	3032-10	H168	306006	H176	315620	H177
2902	H165	300510	H113	3033	H168	306007	H176	315625	H177
2903	H165	300511	H113	3033	H171	306008	H176	315627	H177
2911	H166	300512	H113	3033-10	H168	306010	H176	315630	H177
2912	H166	300513	H113	3034	H168	306012	H176	315640	H177
2913	H166	300514	H113	3034	H171	306014	H176	315645	H177
2921	H167	300515	H113	3034-10	H168	306040	H177	315650	H177
2922	H167	300516	H113	3035	H168	306050	H177	315655	H177
2923	H167	300517	H113	3035	H171	306060	H177	315660	H177
2924	H167	300518	H113	3035-10	H168	306080	H177	315670	H177
2925	H167	300519	H113	3036	H168	3061	H83	315720	H177
2926	H167	300520	H113	3036	H171	306100	H177	315725	H177
2931	H168	300521	H113	3036-10	H168	306120	H177	315727	H177
2932	H168	300522	H113	3037-10	H168	307125	H115	315730	H177
2933	H168	301010	H113	3038-10	H168	307126	H115	315740	H177
2934	H168	301011	H113	3039-10	H168	307127	H115	315745	H177
2935	H168	301012	H113	3040-10	H168	307250	H115	315750	H177
2936	H168	301013	H113	304001	H176	307251	H115	315755	H177
2937	H168	301014	H113	304002	H176	307252	H115	315760	H177
2941-0160	H243	301015	H113	304003	H176	3080	H129	315770	H177
2941-0200	H243	301016	H113	304004	H176	308001	H115	316004	H176
2941-0250	H243	301017	H113	3041	H170	3081	H129	316005	H176
2941-0300	H243	301018	H113	3041	H171	3082	H129	316006	H176
2941-0400	H243	301019	H113	3042	H170	3083	H129	316008	H176
2941-0500	H243	301021	H113	3042	H171	308300	H115	3161	H178
2941-0600	H243	301022	H113	3043	H170	3084	H129	3162	H178
2941-0800	H243	3011-10	H166	3043	H171	3085	H131	3163	H178
2941-1000	H243	3012	H166	3044	H170	3086	H129	3164	H178
2941-1250	H243	3012	H171	3044	H171	3088	H132	3165	H178
2942-0160	H243	3012-10	H166	3045	H170	3093	H170	3171	H178
2942-0200	H243	301208	H113	3045	H171	3093	H171	3172	H178
2942-0250	H243	301209	H113	3046	H170	3094	H170	3173	H178
2942-0300	H243	301210	H113	3046	H171	3094	H171	3174	H178

Artikelnummern-Verzeichnis

Articlenumber List

Art.-Nr. / No.	Seite / Page	Art.-Nr. / No.	Seite / Page	Art.-Nr. / No.	Seite / Page	Art.-Nr. / No.	Seite / Page	Art.-Nr. / No.	Seite / Page
3175	H178	326012	H114	3376-4	H238	3463	H142	3607-45	H207
3181	H178	326014	H114	3377-3	H238	3465	H137	3607-50	H207
3182	H178	326017	H114	3377-4	H238	3465	H142	3613	H208
3183	H178	326019	H114	3378	H238	3466	H141	3619	H208
3184	H178	326105	H114	3379	H238	3466-01	H141	3629	H208
3185	H178	326106	H114	3380	H237	3466-02	H141	3690	H136
3196	H236	326107	H114	3380E	H237	348605	H177	3690	H142
3197	H236	326108	H114	3381-1	H237	348606	H177	3691	H136
320010	H114	326110	H114	3381-2	H237	348608	H177	3692	H136
320011	H114	326112	H114	3381-3	H237	348610	H177	3693	H136
320012	H114	326117	H114	3382-1	H237	348612	H177	3694	H136
320014	H114	326119	H114	3382-2	H237	348614	H177	3701	H165
320016	H114	327005	H114	3382-3	H237	348705	H177	3702	H165
320018	H114	327006	H114	3383-1	H237	348706	H177	3703	H165
320020	H114	327008	H114	3383-2	H237	348708	H177	3711	H166
320022	H114	327010	H114	3383-3	H237	348710	H177	3712	H166
320024	H114	327012	H114	3384-1	H237	348712	H177	3713	H166
3201	H165	327014	H114	3384-2	H237	348714	H177	3731	H168
3202	H165	327016	H114	3384-3	H237	3493	H139	3732	H168
3203	H165	327105	H114	3385-1	H237	3494	H138	3733	H168
321010	H114	327106	H114	3385-2	H237	3494E	H138	3734	H168
321012	H114	327108	H114	3385-3	H237	3494E	H139	3735	H168
321014	H114	327110	H114	3386-2	H237	3494E	H140	3736	H168
321016	H114	327112	H114	3387-1	H237	3494E	H153	3737	H168
321018	H114	327114	H114	3387-2	H237	3496	H139	3750	H180
321020	H114	327116	H114	3387-3	H237	3497	H139	3783-06	H179
321022	H114	3274	H168	3388-2	H237	3498	H138	3783-07	H179
321024	H114	3275	H168	3406	H135	3499	H138	3783-08	H179
3211	H166	3301	H241	3406F	H135	3499E	H138	3783-10	H179
3212	H166	3303	H241	3407	H135	3499E	H138	3783-11	H179
3213	H166	3304	H242	3407F	H135	3499E	H139	3783-12	H179
3221	H167	3304-1	H242	3408	H135	3499E	H139	3783-13	H179
3222	H167	3305	H242	340810	H137	3499E	H140	3784-06	H179
3223	H167	3306	H241	3408F	H135	3499E	H140	3784-07	H179
3224	H167	3307	H242	3409	H135	3499E	H154	3784-08	H179
3225	H167	3307-1	H242	3409F	H135	3500	H138	3784-1/4	H179
3226	H167	3307-2	H242	3410	H135	3500E	H138	3784-10	H179
3228	H168	3311	H241	341013	H137	3500E	H139	3784-11	H179
3229	H168	3311-1	H241	3410F	H135	3500E	H140	3784-12	H179
3231	H168	331112	H241	3411	H135	3501	H140	3784-13	H179
3232	H168	3312	H241	3411F	H135	3502	H139	3784-15	H179
3233	H168	331224	H241	3412	H135	3601	H207	3784-16	H179
3234	H168	3350	H231	341213	H137	3601-1.5	H207	3784-17	H179
3235	H168	3350-2	H231	3412F	H135	3601-10	H207	3784-3/8	H179
3236	H168	3350-3	H231	3413	H135	3601-12	H207	3784-5/16	H179
3237	H168	3350-4	H231	3413F	H135	3601-14	H207	3784-55	H179
3238	H168	3350-5	H231	3414	H135	3601-17	H207	3784-91	H192
3239	H168	3350-6	H231	341415	H137	3601-19	H207	3784-92	H192
3241	H170	3350-8	H231	3414F	H135	3601-2	H207	3784-93	H192
3242	H170	335010	H114	3415	H135	3601-2.5	H207	3784-M10	H179
3243	H170	335015	H114	3415F	H135	3601-3	H207	3784-M12	H179
3247	H170	335020	H114	3416	H135	3601-4	H207	3784-M6	H179
3248	H170	335025	H114	341618	H137	3601-5	H207	3784-M8	H179
3249	H170	335027	H114	3416F	H135	3601-6	H207	3785-08	H179
325015	H114	335030	H114	3417	H135	3601-7	H207	3785-1/4	H179
325020	H114	335040	H114	341719	H137	3601-8	H207	3785-10	H179
325025	H114	335045	H114	3417F	H135	3602	H207	3785-3/8	H179
325027	H114	335050	H114	3418	H135	3602-1.5	H207	3785-5/16	H179
325030	H114	335055	H114	3418F	H135	3602-10	H207	3787	H189
325040	H114	335060	H114	3419	H135	3602-12	H207	3788	H188
325045	H114	335070	H114	3419F	H135	3602-14	H207	3789	H189
325050	H114	3355	H231	3421	H135	3602-17	H207	3790	H188
325055	H114	3355-2	H231	3421F	H135	3602-2	H207	380008	H127
325060	H114	3355-3	H231	3422	H135	3602-2.5	H207	380009	H127
325110	H114	3355-4	H231	3422F	H135	3602-3	H207	380010	H127
325115	H114	3355-5	H231	3424	H135	3602-4	H207	380011	H127
325120	H114	3355-6	H231	3424F	H135	3602-5	H207	380012	H127
325125	H114	3361	H230	3427	H135	3602-6	H207	380013	H127
325127	H114	3362	H230	3427F	H135	3602-7	H207	380014	H127
325130	H114	3370	H231	3430	H135	3602-8	H207	380015	H127
325140	H114	3370-1	H231	3430F	H135	3603	H208	380016	H127
325145	H114	3370-2	H231	3432	H135	3604	H208	380017	H127
325150	H114	3370-3	H231	3432F	H135	3607	H207	380018	H127
325155	H114	3371-1	H231	3434	H135	3607-10	H207	380019	H127
325160	H114	3371-2	H231	3436	H135	3607-15	H207	380020	H127
326005	H114	3375-2	H238	3438	H135	3607-20	H207	380021	H127
326006	H114	3375-3	H238	34411	H135	3607-25	H207	380022	H127
326007	H114	3375-4	H238	34461	H135	3607-27	H207	380023	H127
326008	H114	3375-5	H238	34501	H135	3607-30	H207	380024	H127
326010	H114	3376-3	H238	3463	H137	3607-40	H207	380025	H127

Artikelnummern-Verzeichnis

Articlenumber List

Art.-Nr. / No.	Seite / Page	Art.-Nr. / No.	Seite / Page	Art.-Nr. / No.	Seite / Page	Art.-Nr. / No.	Seite / Page	Art.-Nr. / No.	Seite / Page
380027	H127	3901205	H75	394271	H124	409124	H184	4130-10	H198
380028	H127	39012900	H101	394272	H124	4092	H183	4130-15	H198
380030	H127	39012900	H117	394273	H124	4093	H187	4130-20	H198
380032	H127	39012900-1	H101	394901	H96	409306	H187	4130-25	H198
381000	H128	39012900-1	H117	3961	H239	4094	H186	4130-27	H198
381008	H127	3901401	H64	396205	H232	4095	H185	4130-30	H198
381009	H127	3901402	H64	396213	H232	409512	H185	4130-40	H198
381010	H127	39014900	H101	396221	H233	4097	H186	413010	H122
381011	H127	39014900	H108	396297-01	H233	4100-00	H196	413011	H122
381012	H127	39014900-1	H101	396297-01	H233	4100-01	H196	413012	H122
381013	H127	39014900-1	H108	396297-01	H233	4100-02	H196	413013	H122
381014	H127	3903401	H71	3963	H239	4100-03	H196	413014	H122
381015	H127	3903801	H66	3965	H239	4101	H78	413015	H122
381016	H127	3903802	H67	3968	H239	4102-02	H196	413016	H122
381017	H127	3903803	H73	3973	H239	4109	H120	413017	H122
381018	H127	39038900	H101	397312	H239	4110-00	H197	413018	H122
381019	H127	39038900	H112	3975	H239	4110-01	H197	413019	H122
381020	H127	39038900-1	H101	397512	H239	4110-02	H197	413021	H122
381021	H127	39038900-1	H112	398001	H242	4110-03	H197	413022	H122
381022	H127	3904201	H74	398005	H242	411004	H120	413024	H122
381023	H127	39048201	H76	398210	H226	411005	H120	413027	H122
381024	H127	39048202	H77	398211	H225	411006	H120	413030	H122
381025	H127	3906	H136	398212	H226	411007	H120	413032	H122
381027	H127	3907	H136	39821314D	H227	411008	H120	4131	H79
381028	H127	3908	H136	39821314D	H227	411009	H120	413100	H122
381030	H127	390813	H137	398213GB	H227	411010	H120	413116	H122
381032	H127	3909	H136	398214GB	H227	411011	H120	413121	H122
381214	H128	390915	H137	398215	H225	411012	H120	413712	H122
381214	H179	3910	H136	398230	H227	411013	H120	413725	H122
381234	H128	391019	H137	398250	H228	411045	H120	413812	H122
381238	H128	3911	H136	398251	H228	411055	H120	4150-08	H198
381410	H128	3912	H136	3993	H140	411081	H120	4150-10	H198
382017	H127	3913	H136	3994	H140	4111	H78	4150-15	H198
382019	H127	3914	H136	3999	H140	411100	H120	4150-20	H198
382021	H127	391410	H128	400001	H101	411207	H120	4150-25	H198
382022	H127	3914516	H137	400001	H118	411255	H120	4150-27	H198
382024	H127	3914516	H183	400001-1	H118	411301	H120	4150-30	H198
382117	H127	3915	H136	400190	H118	411302	H120	4150-40	H198
382117-1	H127	3916	H136	400210	H118	411438	H120	4170	H203
382119	H127	391619	H137	400220	H118	411603	H120	4170-10	H203
382119-1	H127	3917	H136	400230	H118	411604	H120	4170-2	H203
382121	H127	3918	H136	400240	H118	411605	H120	4170-25	H203
382121-1	H127	3919	H136	400260	H118	411606	H120	4170-3	H203
383216	H128	3921	H136	400270	H118	411608	H120	4170-4	H203
384010	H128	3922	H136	400290	H118	411610	H120	4170-5	H203
384011	H128	3924	H136	400300	H118	411705	H120	4170-6	H203
384012	H128	3927	H136	400320	H118	411715	H120	4170-8	H203
384014	H128	3930	H136	400350	H118	4119	H121	4180	H203
384016	H128	3932	H136	400360	H118	411915	H120	4180-10	H203
384018	H128	393216	H128	400380	H118	4120-01	H195	4180-15	H203
384020	H128	394020	H83	400410	H118	4120-02	H195	4180-20	H203
384022	H128	394070	H182	400460	H118	4120-03	H195	4180-25	H203
384024	H128	39407010	H182	400500	H118	4120-04	H195	4180-27	H203
385020	H128	394071	H182	4008	H65	4120-05	H195	4180-30	H203
385025	H128	39407110	H182	4009	H82	4120-06	H195	4180-40	H203
385027	H128	394072	H81	4016	H80	412008	H121	4180-45	H203
385030	H128	394073	H187	4016-02	H111	412010	H121	4180-50	H203
385040	H128	394074	H181	4016-03	H111	412011	H121	418008	H130
385045	H128	39407412	H181	4016-10	H111	412012	H121	418010	H130
385050	H128	394075	H181	4016-11	H111	412013	H121	418013	H130
385055	H128	39407512	H181	4016-12	H111	412014	H121	418015	H130
385060	H128	394089	H184	4016-13	H111	412015	H121	418016	H130
385070	H128	39408912	H184	4016-14	H111	412016	H121	418017	H130
3851	H129	394171	H203	4016-15	H111	412017	H121	418018	H130
386004	H128	394172	H203	4016-16	H111	412018	H121	418019	H130
386005	H128	394240	H125	4016-17	H111	412019	H121	418021	H130
386006	H128	394240-1	H126	4016-19	H111	4121	H79	418022	H130
386008	H128	394240-1	H124	4017	H80	4121-02	H195	418024	H130
386010	H128	394240-1	H125	4018	H67	4121-03	H195	418027	H130
386012	H128	394241	H125	4027	H85	412100	H121	418030	H130
386014	H128	394241-1	H124	4028	H69	4122-01	H195	418108	H130
386017	H128	394241-1	H125	407100	H118	412707	H121	418110	H130
386019	H128	394242	H125	407200	H118	412715	H121	418113	H130
3861	H129	394242-1	H125	407400	H118	4129	H122	418115	H130
387075	H128	394242-1	H124	4078	H84	412920	H121	418117	H130
387125	H128	394243	H125	408000	H118	4130-05	H198	418118	H130
3901201	H68	394243-1	H124	4085	H181	4130-06	H198	418119	H130
3901202	H68	394243-1	H125	4090	H185	4130-07	H198	418121	H130
3901203	H69	394260	H126	409006	H185	4130-08	H198	418122	H130
3901204	H70	394270	H124	4091	H184	4130-09	H198	418124	H130

Artikelnummern-Verzeichnis

Articlenumber List

Art.-Nr. / No.	Seite / Page	Art.-Nr. / No.	Seite / Page	Art.-Nr. / No.	Seite / Page	Art.-Nr. / No.	Seite / Page	Art.-Nr. / No.	Seite / Page
418130	H130	4246	H118	4422	H152	4621	H205	480024	H131
4182	H130	4246	H126	4436	H154	4621-180	H215	480025	H131
418217	H130	4247	H118	4437	H154	4621-200	H216	480026	H131
418219	H130	4247	H118	4438	H154	4621-20006	H216	480027	H131
418221	H130	4247	H126	4441	H156	4622	H205	480028	H131
4190-01	H180	4248	H107	4442	H157	4622-01	H195	480029	H131
4190-01	H204	4248	H110	4451	H158	4622-180	H215	480030	H131
4190-03	H180	4248	H126	4452	H159	4623	H205	480032	H131
4190-03	H204	4249	H110	4462	H155	4623-160	H215	480033	H131
4192	H186	4249	H115	4463	H155	4624	H205	480034	H131
4192	H199	4249	H126	4464	H155	4625	H205	480035	H131
419212	H186	4250	H110	4466	H155	4625-200	H215	480036	H131
419212	H199	4250	H115	4468	H159	4626-200	H215	480038	H131
4193	H182	4250	H126	4516-250	H213	4627-160	H215	480041	H131
419312	H182	4251	H115	4517-300	H213	4628-250	H215	480046	H131
4200-1	H101	4251	H118	4550	H218	4629-160	H215	480050	H131
4200-1	H108	4251	H126	4551	H218	4629-210	H215	481000	H131
420000	H107	4252	H118	4552	H218	4630-08	H198	481017	H131
420000	H107	4252	H118	4553-14	H218	4630-10	H198	481018	H131
420000	H107	4252	H126	4553-18	H218	4630-15	H198	481019	H131
420000	H107	4259	H126	4553-24	H218	4630-180	H216	481021	H131
420001	H120	4288	H105	4553-30	H218	4630-20	H198	481022	H131
420011	H120	4288	H180	4553-36	H218	4630-25	H198	481024	H131
4201	H107	4289	H103	4554-14	H218	4630-27	H198	481027	H131
4202	H107	4290	H105	4554-18	H218	4630-30	H198	481029	H131
4203	H107	4290	H180	4554-24	H218	4630-40	H198	481030	H131
4204	H107	4294	H105	4554-30	H218	4631-200	H216	481032	H131
4208	H101	4294	H180	4554-36	H218	4640-230	H214	481036	H131
4208	H108	4295	H105	4555	H218	4640-260	H214	481041	H131
4210-1	H101	4295	H177	4556-175	H219	4643-180	H214	481046	H131
4210-1	H112	4295	H180	4556-250	H219	4643-210	H214	481050	H131
421000	H111	4297	H104	4557-150	H220	4670-02	H204	482619	H131
421000	H111	4297	H235	4557-340	H213	4670-03	H204	483410	H131
421000	H111	4297-1	H104	4557-430	H213	4670-04	H204	483412	H131
421000	H111	4297-1	H235	4557-550	H213	4670-05	H204	485027	H131
421001	H111	4297-10	H104	4559-340	H213	4670-06	H204	487100	H131
421001	H121	4297-10	H235	4559-430	H213	4670-08	H204	487200	H131
421011	H111	4297-2	H104	4559-550	H213	4670-10	H204	4901-50	H22
421011	H121	4297-2	H235	4559-650	H213	4670-25	H204	4901-501	H29
4211	H111	4297-3	H104	4561-205	H219	4680	H221	4901-502	H30
4212	H111	4297-3	H235	4561-245	H219	4680-10	H204	4901-511	H31
4213	H111	4298	H103	4562-225	H219	4680-15	H204	4901-521	H34
4214	H111	4298-1	H103	4563-275	H219	4680-20	H204	4901-522	H33
4218	H101	4299	H104	4584	H218	4680-25	H204	4901-523	H32
4218	H112	4330-130	H220	4584	H222	4680-27	H204	4901-541	H35
4220-1	H101	4331-120	H220	4600-00	H196	4680-30	H204	492619	H131
4220-1	H117	4332-130	H220	4600-01	H196	4680-40	H204	495027	H131
422000	H115	4333-120	H220	4600-02	H196	4681	H221	4963	H244
422000	H115	4334-110	H220	4600-03	H196	4683	H222	4963-01	H91
422000	H115	4383	H222	4600-1230	H197	4683-A2	H217	500000	H101
422000	H116	4383-A1	H217	4600-1231	H197	4683-A21	H217	500000	H118
422000	H116	4383-A11	H217	4601-165	H211	4683-J2	H217	500360	H118
422000	H116	4383-A2	H217	4601-180	H211	4683-J21	H217	500380	H118
422000	H116	4383-A21	H217	4601-200	H211	4690-02	H180	500410	H118
422000	H116	4383-A3	H217	4601-20006	H211	4690-02	H199	500460	H118
422000	H116	4383-A31	H217	4602-01	H196	4690-02	H204	500500	H118
422000	H116	4383-J1	H217	4602-02	H196	4690-07	H204	500540	H118
422000	H122	4383-J11	H217	4602-180	H211	4690-08	H204	500550	H118
422001	H116	4383-J2	H217	4603-145	H211	4690-10	H204	500580	H118
422001	H122	4383-J21	H217	4603-160	H211	4690-13	H204	500600	H118
422011	H116	4383-J3	H217	4604-180	H211	4691	H221	500630	H118
422011	H122	4383-J31	H217	4605-170	H212	4691-14	H180	500650	H118
4221	H115	4402	H158	4605-200	H212	4691-14	H204	500670	H118
4222	H115	4402E	H158	4606-200	H212	4692-06	H199	500700	H118
4223	H115	4403	H159	4607-160	H212	4692-07	H199	500710	H118
4224	H116	4403E	H159	4608-250	H213	4692-08	H199	500750	H118
4228	H101	4405	H156	4609-175	H213	4711	H200	500770	H118
4228	H117	4405E	H156	4609-240	H213	4714	H200	500800	H118
423000	H120	4405E	H156	4609-300	H213	4721	H206	507200	H118
423000	H121	4407	H153	4609-400	H213	4722	H206	507400	H118
4231	H116	4407E	H153	4610-00	H197	4723	H206	508000	H118
4232	H116	4407E	H154	4610-01	H197	4724	H206	508560	H101
4233	H116	4408	H152	4610-02	H197	4725	H206	508560	H118
4234	H116	4408E	H152	4610-03	H197	4727	H206	5100-01	H196
4235	H116	4408E	H154	4618-250	H213	480017	H131	5100-02	H196
4236	H116	4410	H153	4620-01	H195	480019	H131	510000	H118
4245	H107	4410E	H153	4620-02	H195	480020	H131	5105-00	H201
4245	H110	4411	H157	4620-03	H195	480021	H131	5105-01	H201
4245	H126	4411E	H157	4620-04	H195	480022	H131	5105-02	H201
4246	H115	4421	H152	4620-05	H195	480023	H131	5105-1230	H201

Artikelnummern-Verzeichnis

Articlenumber List

Art.-Nr. / No.	Seite / Page	Art.-Nr. / No.	Seite / Page	Art.-Nr. / No.	Seite / Page	Art.-Nr. / No.	Seite / Page	Art.-Nr. / No.	Seite / Page
5115-00	H201	581000	H132	5954-002	H28	5999-16E	H48	6297-05	H234
5115-01	H201	581034	H132	5954-002	H99	5999-17I	H52	6299-01	H232
5115-02	H201	587019	H132	5954-003	H28	5999-17E	H52	6299-01	H232
5120-02	H195	587200	H132	5954-003	H99	5999-18I	H51	6299-01	H232
5120-03	H195	5900	H21	597019	H132	5999-18E	H51	6299-01	H232
5120-04	H195	5900-101	H29	5995-001	H29	5999-19I	H42	6299-01	H232
5120-05	H195	5900-102	H30	5995-002	H30	5999-19E	H42	6299-02	H233
5125-01	H201	5900-111	H31	5995-011	H31	5999-21I	H54	6299-05	H232
5125-03	H201	5901	H19	5995-021	H34	5999-21E	H54	6299-06	H233
5125-04	H201	5901-101	H29	5995-022	H33	5999-22I	H54	6299-07	H232
5125-05	H201	5901-102	H30	5995-023	H32	5999-22E	H54	6299-07	H232
5125-06	H201	5901-111	H31	5995-141	H35	5999-23I	H54	6299-07	H232
5190	H201	5901-121	H34	5996-001	H16	5999-23E	H54	6299-07	H232
5195	H202	5901-122	H33	5996-001	H24	5999-32I	H36	6299-07	H232
5199	H205	5901-123	H32	5997-001	H24	5999-32E	H36	6530024	H242
5200	H104	5901-141	H35	5997-002	H24	5999-33I	H49	6911	H14
5200	H108	5901-20	H19	5997-003	H24	5999-33E	H49	6911-10	H15
5200-1	H104	5901-201	H29	5997-009	H16	5999-34I	H47	6911-101	H29
5200-1	H108	5901-202	H30	5997-010	H16	5999-34E	H47	6911-102	H30
5201	H104	5901-211	H31	5997-011	H24	5999-35I	H47	6911-111	H31
5201	H108	5901-221	H34	5997-012	H24	5999-35E	H47	6911-121	H34
5201-1	H104	5901-222	H33	5997-013	H24	5999-36I	H51	6911-122	H33
5201-1	H108	5901-223	H32	5997-014	H24	5999-36E	H51	6911-123	H32
5201-2	H104	5901-241	H35	5997-015	H24	5999-37I	H43	6911-141	H35
5201-2	H108	5901-50	H19	5997-016	H24	5999-37E	H43	6911-99	H15
5204	H102	5901-511	H31	5997-017	H16	5999-39I	H52	6912	H16
5204	H108	5901-521	H34	5997-026	H18	5999-392	H52	6913	H16
5205	H102	5901-522	H33	5997-027	H18	5999-393	H52	6914	H16
5205	H108	5901-523	H32	5997-028	H18	5999-41I	H37	7901-50	H17
5205	H120	5901-541	H35	5997-029	H18	5999-41E	H37	7901-501	H29
5205-1	H102	5901-551	H29	5998-001	H16	5999-42I	H41	7901-502	H30
5205-1	H108	5901-552	H30	5998-001	H24	5999-42E	H41	7901-511	H31
5205-1	H120	5902	H20	5998-001SPACE	H18	5999-43I	H42	7901-521	H34
5210	H104	5902-01	H53	5999-011	H36	5999-43E	H42	7901-522	H33
5210	H112	5902-02	H53	5999-01E	H36	5999-44I	H41	7901-523	H32
5210-1	H104	5902-20	H20	5999-02I	H37	5999-44E	H41	7901-541	H35
5210-1	H112	5902-201	H53	5999-02E	H37	5999-45I	H50	8601	H81
5211	H104	5902-202	H53	5999-03I	H37	5999-45E	H50	8604	H190
5211	H112	5902-50	H20	5999-03E	H37	5999-46I	H49	8605	H107
5211-1	H104	5902-501	H53	5999-04I	H38	5999-46E	H49	8606	H191
5211-1	H112	5902-502	H53	5999-04E	H38	5999-47I	H50	8651	H84
5211-2	H104	5907	H23	5999-05I	H38	5999-47E	H50	8652	H84
5211-2	H112	5907-20	H23	5999-052	H38	5999-48I	H45	8653	H86
5214	H102	5907-50	H23	5999-05E	H38	5999-48E	H45	8654	H86
5214	H112	5908	H23	5999-05E	H38	5999-51I	H40	8655	H87
5215	H102	5908-20	H23	5999-06I	H45	5999-51E	H40	8656	H87
5215	H112	5908-50	H23	5999-062	H44	5999-52I	H40	8661	H85
5215	H121	5909	H23	5999-062E	H44	5999-52E	H40	8662	H85
5215-1	H102	5910	H23	5999-064	H44	5999-53I	H40	8663	H88
5215-1	H112	5911	H23	5999-064E	H44	5999-53E	H40	8664	H88
5215-1	H121	5912	H23	5999-065	H44	5999-55I	H41	8681	H90
5220	H104	5912-10	H23	5999-065E	H44	5999-55E	H41	8681K	H244
5220	H117	5913	H23	5999-06E	H45	6202	H232	8682	H92
5220-1	H104	5914	H25	5999-07I	H45	6211	H232	8682K	H244
5220-1	H117	5915	H25	5999-071E	H45	6212	H232	8683	H94
5221	H104	5916	H25	5999-072	H46	6214	H232	8683K	H244
5221	H117	5917	H25	5999-072E	H46	6215	H233	8684	H93
5221-1	H104	5918	H25	5999-072E	H46	6216	H233	8684K	H244
5221-1	H117	5919	H25	5999-073	H46	6222	H233	8685	H95
5221-2	H104	5920	H25	5999-074	H46	6223	H233	8685K	H244
5221-2	H117	5921	H23	5999-074E	H46	6224	H234	8686	H96
5224	H102	5922	H23	5999-082	H47	6241	H236	8687	H202
5224	H117	5953	H27	5999-082E	H47	6241-1	H236	8688	H89
5225	H102	5953	H98	5999-09I	H48	6242	H236	9961	H153
5225	H117	5953-011	H27	5999-092	H48	6251	H236	9981	H138
5225	H122	5953-011	H98	5999-09E	H48	6252	H235	9985	H214
5225-1	H102	5953-021	H27	5999-09E	H48	6253	H235	9986	H234
5225-1	H117	5953-021	H98	5999-10I	H49	6258	H236	9988	H156
5225-1	H122	5953-065	H27	5999-10E	H49	6261	H235		
580024	H132	5953-065	H98	5999-11I	H39	6261-01	H235		
580027	H132	5953-082	H27	5999-11E	H39	6263	H235		
580030	H132	5953-082	H98	5999-12I	H39	6263-01	H235		
580032	H132	5953-101	H27	5999-12E	H39	6271	H234		
580033	H132	5953-101	H98	5999-13I	H39	6271-10	H234		
580034	H132	5953-131	H27	5999-13E	H39	6271-12	H234		
580036	H132	5953-131	H98	5999-14I	H43	6271-14	H234		
580038	H132	5954	H28	5999-14E	H43	6271-17	H234		
580041	H132	5954	H99	5999-15I	H43	6271-20	H234		
580046	H132	5954-001	H28	5999-15E	H43	6271-24	H234		
580050	H132	5954-001	H99	5999-16I	H48	6271-28	H234		

Stichwortverzeichnis Handwerkzeuge englisch

Index Hand Tools English

Article	Page
F	
file cleaner	238
files	237
flare nut wrench sets	157, 158
flare nut wrenches	149
flat chisel	231
flexible extension bar 1/4"	107
flexible ratchet wrenches	135, 139
foldable wooden ruler	239
G	
GearTech ratchet wrenches	134 - 142
go-through extension bar 3/8"	111
go-through sockets 3/8"	111
go-through sockets sets	80
grip pliers	219, 220
H	
hack saw	242
hammer	230
hex bit socket 1/2"	114
hex bit sockets 1/4"	106, 107
hex bit sockets 3/8"	110
hex bits 1/4"	170, 171, 173
hex bits 10 mm	177
hex bits 5/16"	176
hex keys	207, 208
hex screwdriver	203, 204
hole punch	236
hook driver 1/4"	178
I	
impact adapter	127 - 132
impact extension bars	127 - 132
impact sockets 1"	132
impact sockets 1/2"	127 - 129
impact sockets 3/4"	131
impact universal joint	127 - 132
inch bits 1/4"	170
inch combination wrench sets	155
inch combination wrenches	145
inch hex keys	207, 208
inch nut setter 1/4"	179
inch ratchet wrenches	141
inch sockets 1/2"	113
inch sockets 1/4"	106
inch sockets 3/8"	109
inlays for roller cabinets	29 - 52
inlays for tool boxes	36 - 54
interchangeable screwdriver sets VDE	202
K	
knives	241
L	
LED lights	224 - 228
lights	224 - 228
long combination wrench sets	154
long combination wrenches	145
long nose pliers	212, 215
M	
machinist hammer	230
magnetic nut setter 1/4"	179
magnetic pick up tool	236
magnetic socket holders 1/2"	116, 122
magnetic socket holders 1/4"	120
magnetic socket holders 3/8"	111, 121
magnetic trays	25
measuring tapes	239
mesh cutter	218
milling cutter	234
mixed sockets	64 - 96, 107 - 122
MultiFit socket sets 1/4"	81
multifunctional pliers VDE	216

Article	Page
N	
nut setter 1/4"	179
O	
P	
Phillips bits 1/4"	165, 171 - 175
Phillips bits 5/16"	176
Phillips screwdriver	196, 197, 201
Phillips bit sockets 1/4"	106, 107
Phillips bit sockets 3/8"	109
pick up tool	236
pin for impact sockets	128, 131, 132
pin punches	231
pincers	214
pipe wrenches	213, 214
plastic tube cutter	235
plier wrench for fittings	213
pliers	210 - 222
pliers sets	221, 222
pointed chisel	231
Pozidriv bits 1/4"	166, 171 - 175
Pozidriv bits 5/16"	176
Pozidriv screwdriver	197, 201
Pozidriv bit sockets 1/4"	106
Pozidriv bit sockets 3/8"	109
precision screwdriver	200, 202
proficraft socket sets 1/4"	84 - 88
proficraft tool sets	89 - 96, 202
PROForm Box	27, 28
PROForm inlays	36 - 54
powder for chalk liner	240
PUK saw	242
punches	231
R	
rasp	237
ratchet handle 1"	101, 118
ratchet handle 1/2"	101 - 104, 117
ratchet handle 1/4"	101, 102, 104, 105, 108, 118
ratchet handle 3/4"	101, 118
ratchet handle 3/8"	101, 102, 112
ratchet wrench sets	138 - 142
ratchet wrenches	134 - 142
reversible ratchet wrenches	136, 137, 140
ring for impact sockets	128, 131, 132
Robertson bits 1/4"	178
roller cabinet	12 - 35
roofing hammer	230
ruler	239
S	
sanitary cross wrench	235
sanitary ratchet handle	235
sanitary tools	232, 236
sanitary wrench	235
saws	242
screw clamps	234
screw extractor	240
screw tight tool for setting screws 1/4"	179
screwdriver	194 - 206
screwdriver sets	202 - 206
security bit sets	188 - 198
security bits 1/4"	178
security utility knife	241
self grip pliers	219, 220
side cutter	209, 215, 220
single open end wrenches	148
SIT bits 1/4"	178
sliding t-handle 3/4"	118
sliding t-handle 1/2"	115
slotted bit sockets 1/4"	106
slotted bit sockets 3/8"	109
slotted bits 1/4"	167, 172, 174, 175
slotted bits 5/16"	176
slotted screwdriver	195
sockets 1"	118
sockets 1/2"	113 - 116
sockets Xi-on 1/2"	122

Article	Page
sockets 1/4"	64, 65
sockets Xi-on 1/4"	120
sockets 3/4"	118
sockets 3/8"	109 - 111
sockets Xi-on 3/8"	121
socket screwdriver	199, 204
Socket sets 1"	72
socket sets 1/2"	68 - 70
socket sets Xi-on 1/2"	79
socket sets 1/4"	64 - 65
socket sets Xi-on 1/4"	78 - 79
socket sets 3/4"	71
socket sets 3/8"	66, 67
socket sets Xi-on 3/8"	78
Spanner bits 1/4"	178
spark plug hand brush	238
spark plug sockets	109, 113
spinner handle 1/4"	107, 120
spirit level	240
spline bit sockets 1/2"	114
spline bits 1/4"	178
spline bits 10 mm	176
stainless steel wire hand brush	238
steel wire hand brush	238
stoning hammer	230
T	
tamper bits 1/4"	169, 170, 173
tamper bits 5/16"	176, 177
tamper hex bits 1/4"	170
tamper TORX bits 10 mm	177
tamper TORX screwdriver	198, 206
tamper TORX bits 10 mm	177
taper punches	231
telescopic pick up tool	236
T-handle screwdriver	203, 204
through-hole open-socket wrenches	151
tinmans shears	218
tool bags	96, 202
tool cases	73 - 77, 87 - 96
tool chests	12 - 35
tool sets	73 - 77, 87 - 96
tool trolley	202, 221
torsions-bits	175
Torq bits 1/4"	178
torque wrenches	123 - 126
TORX bit sockets 3/8"	110
TORX Bits 1/4"	168, 169, 171, 173 - 175
TORX bits 10 mm	177
TORX bits 5/16"	176
TORX bit sockets 1/2"	114
TORX bit sockets 1/4"	106
TORX bit sockets 3/8"	110
TORX double ring wrench sets	141
TORX double ring wrenches	141
TORX impact sockets 1/2"	128
TORX impact bit socket 1/2"	128
TORX ratchet wrench	141
TORX screwdriver	198, 203 - 206
TORX screwdriver with T-handle	203, 204
TORX sockets 1/2"	114
TORX sockets 1/4"	106
TORX sockets 3/8"	110
tower pincers	214
Tri-Wing bits 1/4"	178
trolley	191, 244
tube cutter	232 - 235
tube deburrer	236
TX bit sockets 1/2"	114
TX bit sockets 1/4"	106
TX bit sockets 3/8"	110
TX bits 1/4"	168, 169, 171, 173 - 175
TX bits 10 mm	177
TX bits 5/16"	176
TX double ring wrench sets	141
TX double ring wrenches	141
TX hex keys	207, 208
TX impact sockets 1/2"	128
TX impact bit socket 1/2"	128
TX ratchet wrench	141
TX screwdriver	198, 203 - 206

Article	Page
TX screwdriver with T-handle	203, 204
TX sockets 1/2"	114
TX sockets 1/4"	106
TX sockets 3/8"	110
U	
universal handle 1"	118
universal joint 1"	118
universal joint 1/2"	115, 122
universal joint 1/4"	107, 120
universal joint 3/8"	110, 121
universal key	242
universal screwdriver PH/PZ	197, 201
universal screwdriver PH/PZ VDE	201
utility knives	241
V	
VDE pliers	202, 215, 216, 221
VDE screwdriver	201, 202
vernier caliper	240
voltage tester	200
W	
water tap milling cutter	234
waterpump pliers	213 - 215
welding grip pliers	219, 220
wire hand brushes	238
wire stripping pliers	212, 215
wood chisel	230
working lights	228
workpad	242
X	
Xi-on impact sockets 1/2"	130
Xi-on sockets 1/2"	122
Xi-on sockets 1/4"	120
Xi-on sockets 3/8"	121
Xi-on socket sets 1/2"	79
Xi-on socket sets 1/4"	78, 79
Xi-on socket sets 3/8"	78

Ihr Fachhändler/*Your Retailer:*

201506HKATOP_DE

PROJAHN[®]

Handwerkzeuge
Hand Tools